

Ministerio de Comercio, Industria y Turismo
Artesanías de Colombia S.A.
Proyecto empresarial de innovación y desarrollo técnico

Diseño e Innovación Tecnológica aplicados en el proceso de desarrollo del sector artesanal y la ejecución del plan de transferencia aprobado por el SENA

Asesoría en diseño para diversificación y mejoramiento de productos artesanales en Tibaná - Boyacá

**ANEXO
FICHAS DE PRODUCTO Y PLANOS TÉCNICOS**

D.I. Leyla Marcela Molina Caro

Junio 2006





FORMATO
Ficha de Dibujo y Planos Técnicos

CODIGO: FORASD 07

FECHA: 2004 06 04

VERSION 1

Página 1 de 2



Subgerencia de Desarrollo - Centro de Diseño para la Artesanía y las Pymes

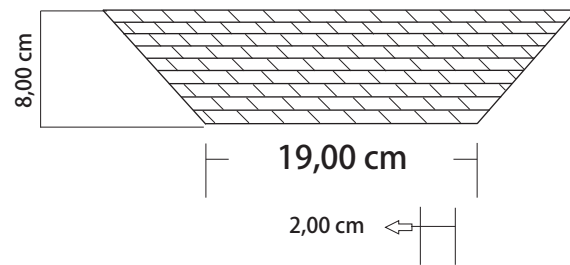
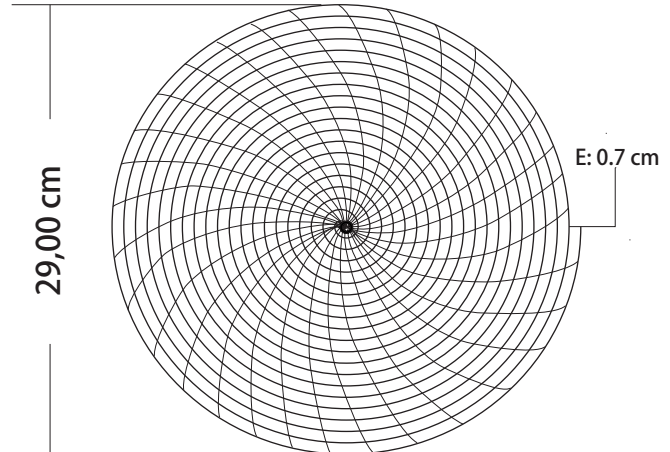
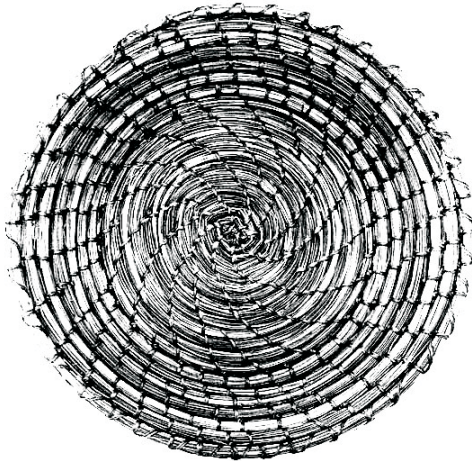



Pieza:	Línea:	ESC. (Cm):	PL.
Nombre:	Referencia:		
Oficio:	Materia Prima:		
Técnica:			

Proceso de Producción:

Observaciones:

Responsable: _____ Fecha: _____

Referente(s) Muestra Línea Empaque

	FORMATO Ficha de Dibujo y Planos Técnicos	CODIGO: FORASD 07 FECHA: 2004 06 04		
		VERSION 1	Página 1 de 2	

Subgerencia de Desarrollo - Centro de Diseño para la Artesanía y las Pymes

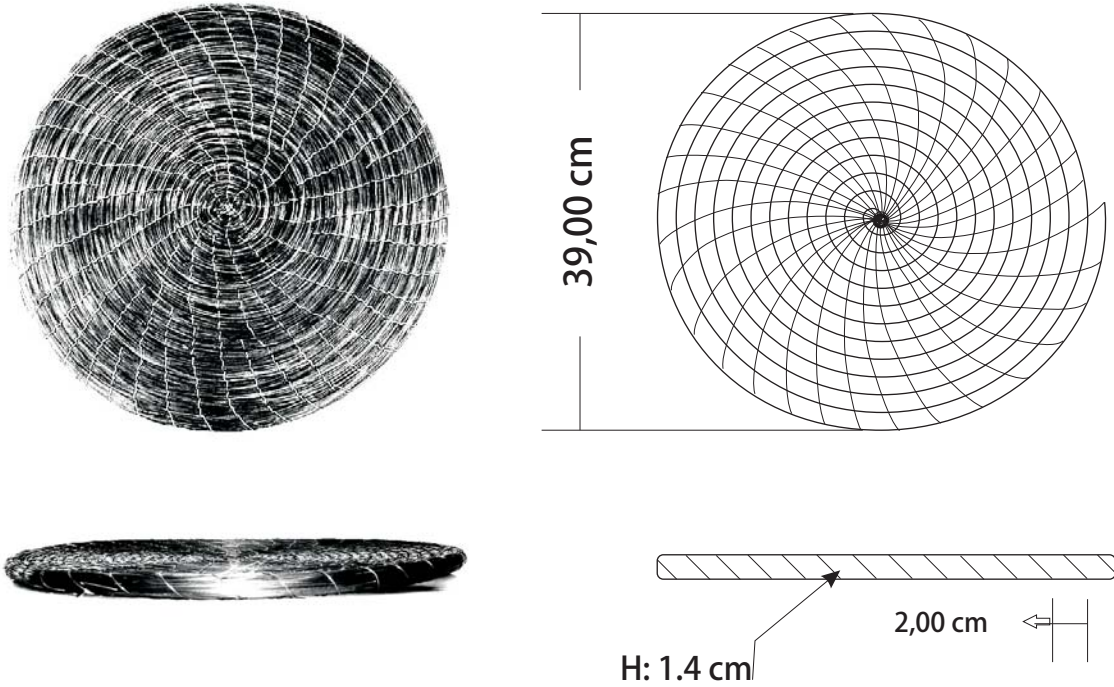



Pieza:	Línea:	ESC. (Cm):	PL.
Nombre:	Referencia:		
Oficio:	Materia Prima:		
Técnica:			

Proceso de Producción:

Observaciones:

Responsable:	Fecha:
--------------	--------

Referente(s) Muestra Línea Empaque

	FORMATO Ficha de Dibujo y Planos Técnicos	CODIGO: FORASD 07 FECHA: 2004 06 04		
		VERSION 1	Página 1 de 2	

Subgerencia de Desarrollo - Centro de Diseño para la Artesanía y las Pymes

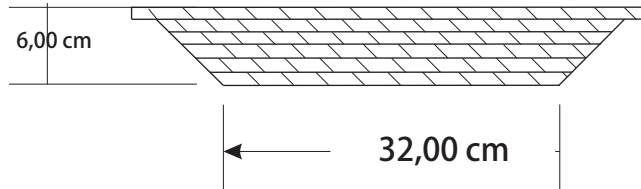
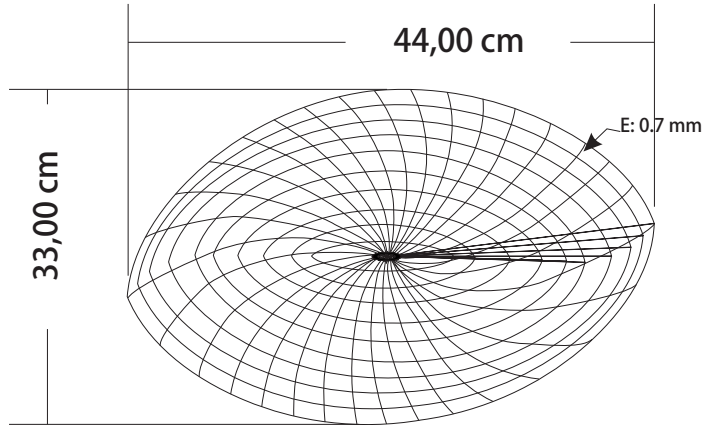
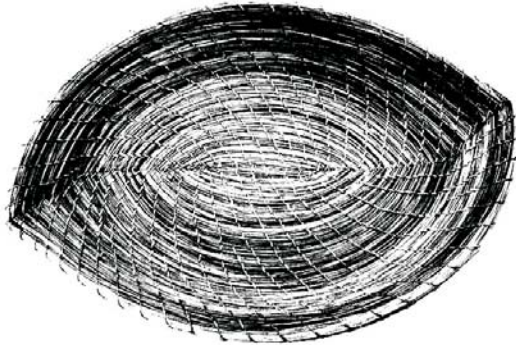

Pieza:	Línea:	ESC. (Cm):	PL.
Nombre:	Referencia:		
Oficio:	Materia Prima:		
Técnica:			



Proceso de Producción:

Observaciones:

Responsable: _____ Fecha: _____

Referente(s)

- Muestra
 Línea
 Empaque

	FORMATO Ficha de Dibujo y Planos Técnicos	CODIGO: FORASD 07 FECHA: 2004 06 04		
		VERSION 1	Página 1 de 2	

Subgerencia de Desarrollo - Centro de Diseño para la Artesanía y las Pymes

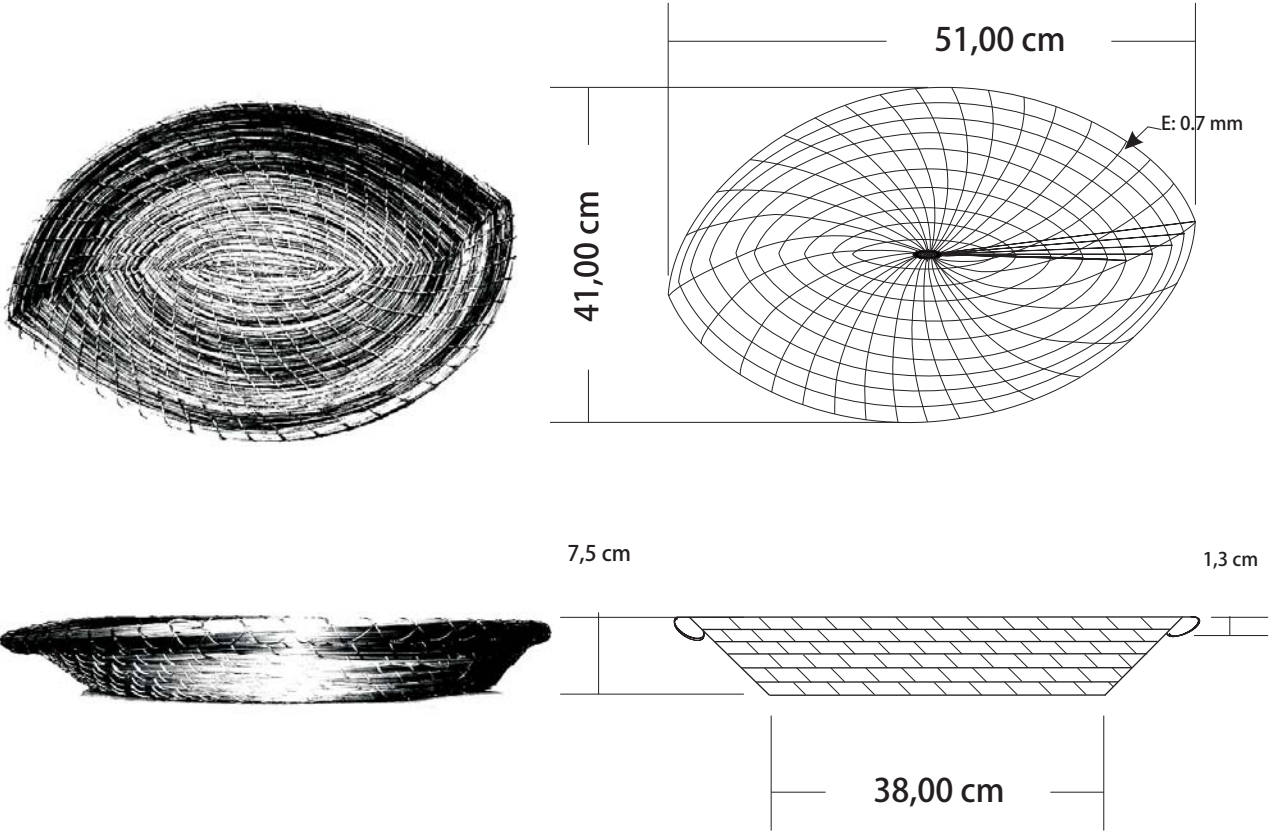



Pieza:	Línea:	ESC. (Cm):	PL.
Nombre:	Referencia:		
Oficio:	Materia Prima:		
Técnica:			

Proceso de Producción:

Observaciones:

Responsable:	Fecha:
--------------	--------

Referente(s) Muestra Línea Empaque

	FORMATO Ficha de Dibujo y Planos Técnicos	CODIGO: FORASD 07 FECHA: 2004 06 04		
		VERSION 1	Página 1 de 2	

Subgerencia de Desarrollo - Centro de Diseño para la Artesanía y las Pymes

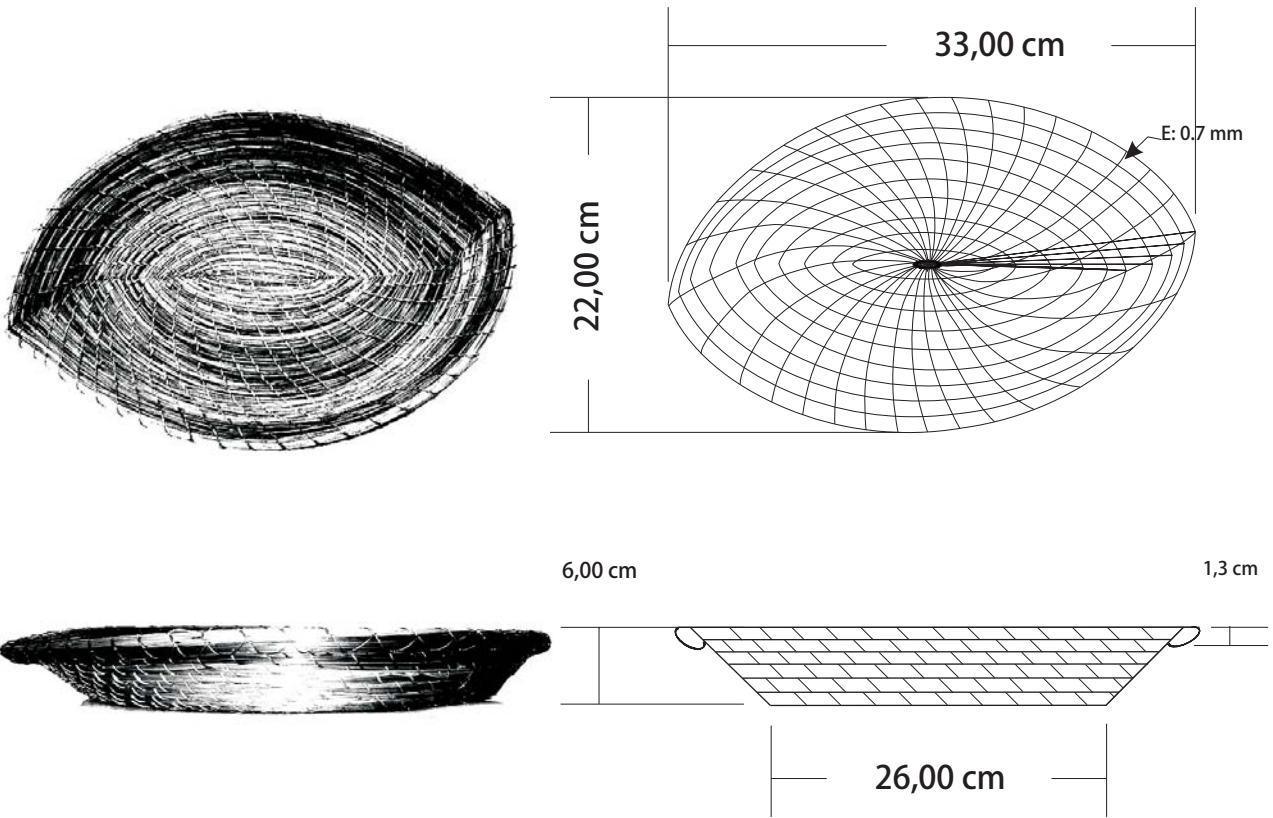

Pieza:	Línea:	ESC. (Cm):	PL.
Nombre:	Referencia:		
Oficio:	Materia Prima:		
Técnica:			



Proceso de Producción:

Observaciones:

Responsable:	Fecha:
--------------	--------

Referente(s)

- Muestra
 Línea
 Empaque

	FORMATO Ficha de Dibujo y Planos Técnicos	CODIGO: FORASD 07 FECHA: 2004 06 04	 
		VERSION 1	Página 1 de 2

Subgerencia de Desarrollo - Centro de Diseño para la Artesanía y las Pymes

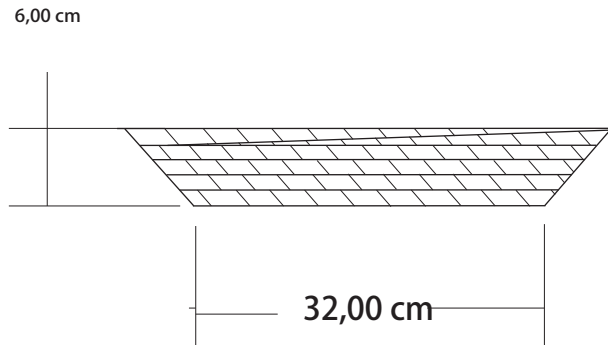
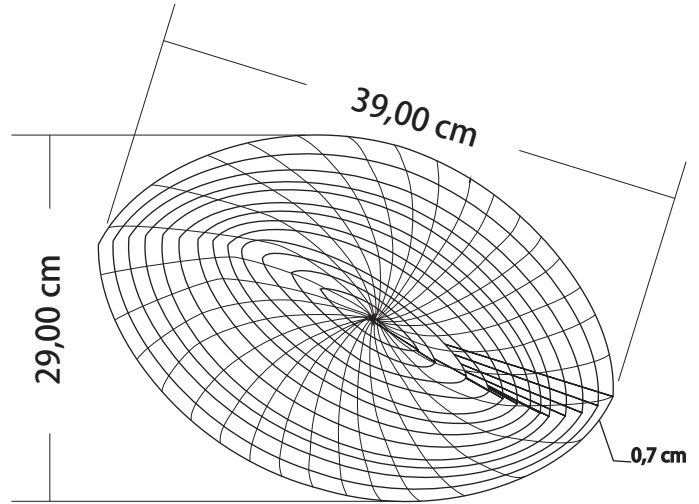
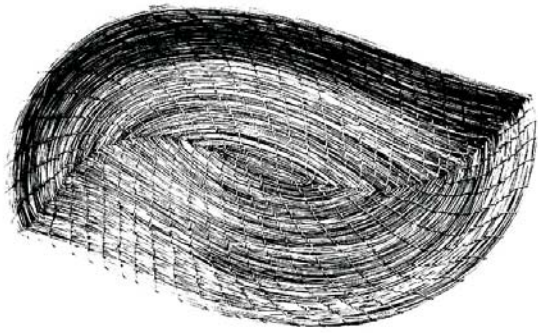

Pieza:	Línea:	ESC. (Cm):	PL.
Nombre:	Referencia:		
Oficio:	Materia Prima:		
Técnica:			



Proceso de Producción:

Observaciones:

Responsable:	Fecha:
--------------	--------

Referente(s)

- Muestra
 Línea
 Empaque

	FORMATO Ficha de Dibujo y Planos Técnicos	CODIGO: FORASD 07 FECHA: 2004 06 04		
		VERSION 1	Página 1 de 2	

Subgerencia de Desarrollo - Centro de Diseño para la Artesanía y las Pymes

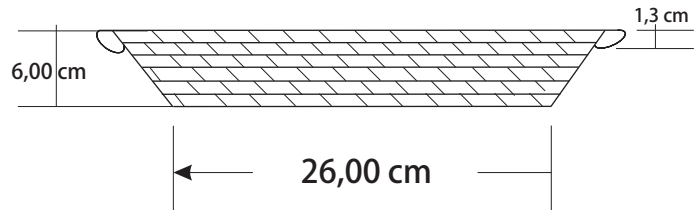
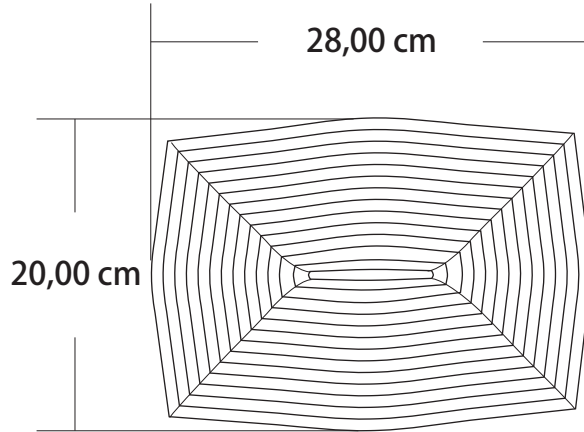

Pieza:	Línea:	ESC. (Cm):	PL.
Nombre:	Referencia:		
Oficio:	Materia Prima:		
Técnica:			



Proceso de Producción:

Observaciones:

Responsable:	Fecha:
--------------	--------

Referente(s)

- Muestra
 Línea
 Empaque

	FORMATO Ficha de Dibujo y Planos Técnicos	CODIGO: FORASD 07 FECHA: 2004 06 04		
		VERSION 1	Página 1 de 2	

Subgerencia de Desarrollo - Centro de Diseño para la Artesanía y las Pymes

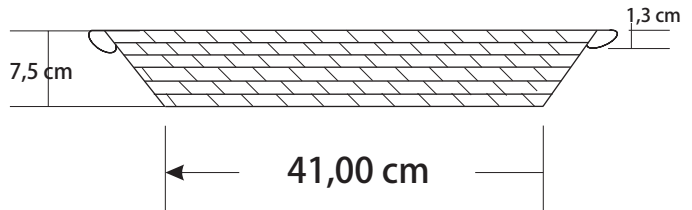
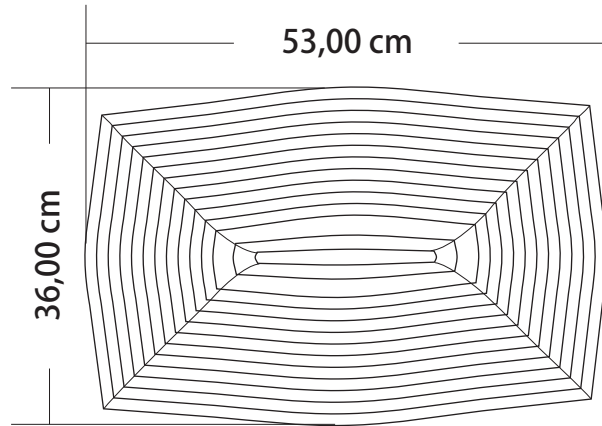
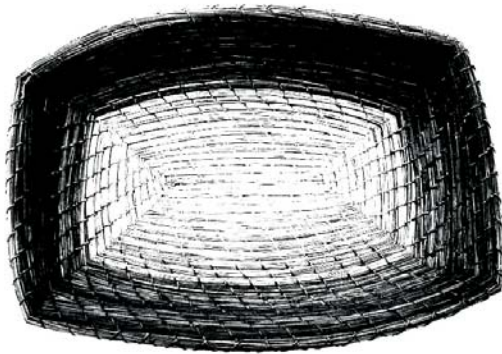

Pieza:	Línea:	ESC. (Cm):	PL.
Nombre:	Referencia:		
Oficio:	Materia Prima:		
Técnica:			



Proceso de Producción:

Observaciones:

Responsable:	Fecha:
--------------	--------

Referente(s)

- Muestra
 Línea
 Empaque

	FORMATO Ficha de Dibujo y Planos Técnicos	CODIGO: FORASD 07 FECHA: 2004 06 04	 
		VERSION 1	Página 1 de 2

Subgerencia de Desarrollo - Centro de Diseño para la Artesanía y las Pymes

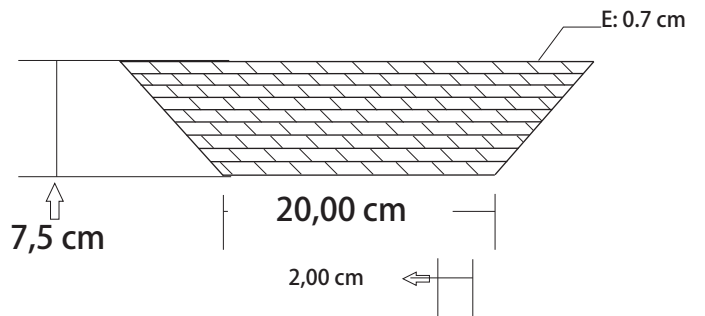
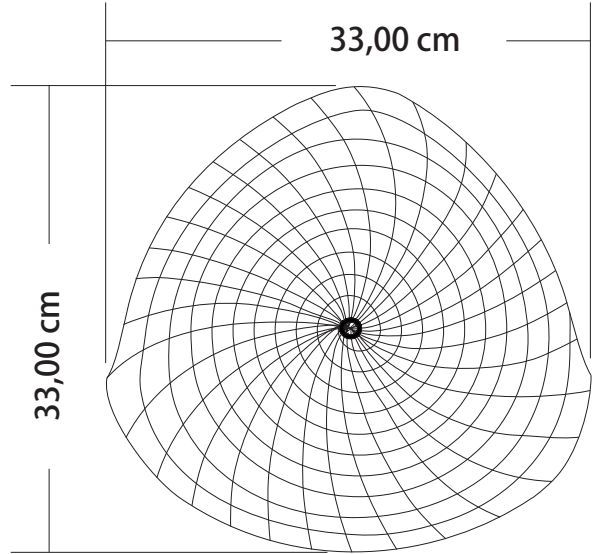
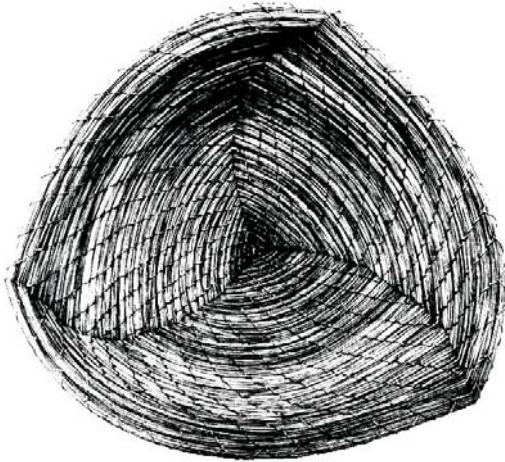

Pieza:	Línea:	ESC. (Cm):	PL.
Nombre:	Referencia:		
Oficio:	Materia Prima:		
Técnica:			



Proceso de Producción:

Observaciones:

Responsable: _____ Fecha: _____

Referente(s)

- Muestra
 Línea
 Empaque

	FORMATO Ficha de Dibujo y Planos Técnicos	CODIGO: FORASD 07 FECHA: 2004 06 04	 
		VERSION 1	Página 1 de 2

Subgerencia de Desarrollo - Centro de Diseño para la Artesanía y las Pymes

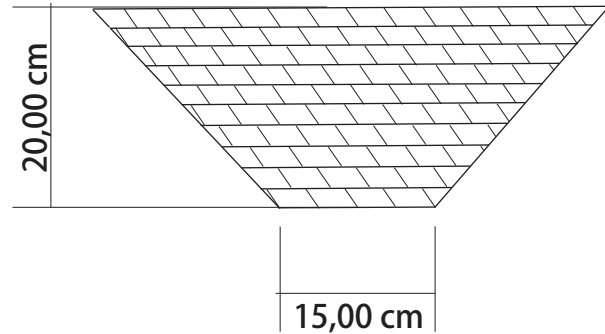
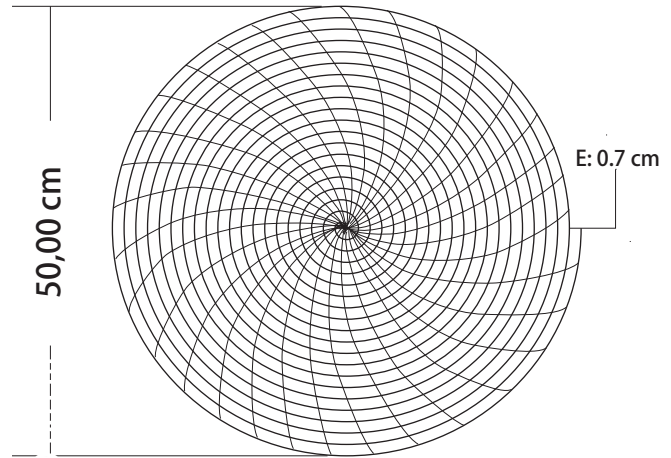

Pieza:	Línea:	ESC. (Cm):	PL.
Nombre:	Referencia:		
Oficio:	Materia Prima:		
Técnica:			



Proceso de Producción:

Observaciones:

Responsable: _____ Fecha: _____

Referente(s)

- Muestra
 Línea
 Empaque

	FORMATO Ficha de Dibujo y Planos Técnicos	CODIGO: FORASD 07 FECHA: 2004 06 04	 
		VERSION 1	Página 1 de 2

Subgerencia de Desarrollo - Centro de Diseño para la Artesanía y las Pymes

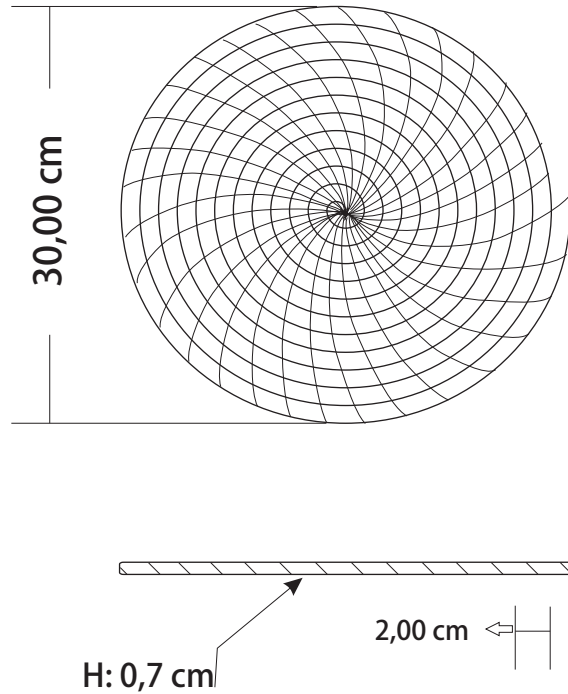
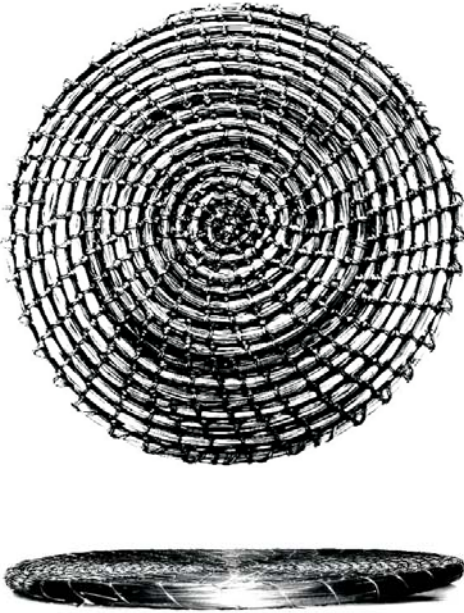

Pieza:	Línea:	ESC. (Cm):	PL.
Nombre:	Referencia:		
Oficio:	Materia Prima:		
Técnica:			



Proceso de Producción:

Observaciones:

Responsable:	Fecha:
--------------	--------

Referente(s)

- Muestra
 Línea
 Empaque

	FORMATO Ficha de Dibujo y Planos Técnicos	CODIGO: FORASD 07 FECHA: 2004 06 04	 
		VERSION 1	Página 1 de 2

Subgerencia de Desarrollo - Centro de Diseño para la Artesanía y las Pymes

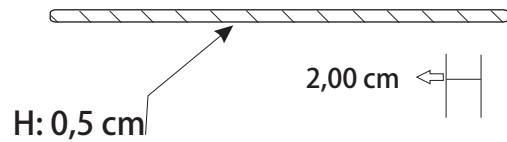
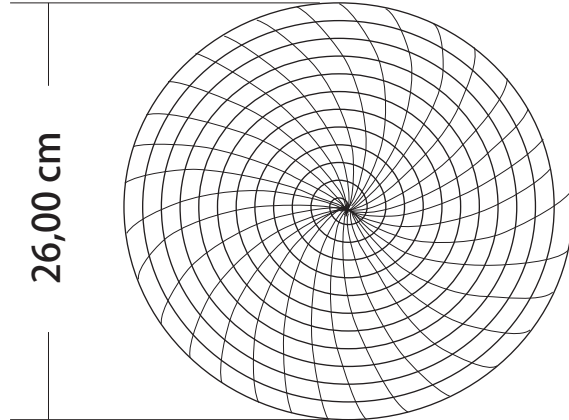

Pieza:	Línea:	ESC. (Cm):	PL.
Nombre:	Referencia:		
Oficio:	Materia Prima:		
Técnica:			



Proceso de Producción:

Observaciones:

Responsable:	Fecha:
--------------	--------

Referente(s)

- Muestra
 Línea
 Empaque

	FORMATO Ficha de Dibujo y Planos Técnicos	CODIGO: FORASD 07 FECHA: 2004 06 04	 
		VERSION 1	Página 1 de 2

Subgerencia de Desarrollo - Centro de Diseño para la Artesanía y las Pymes

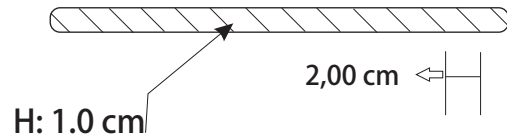
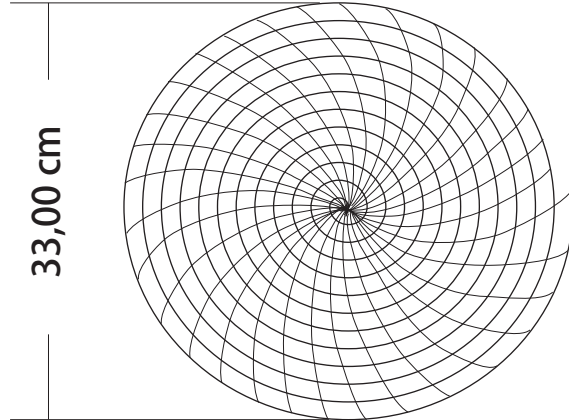

Pieza:	Línea:	ESC. (Cm):	PL.
Nombre:	Referencia:		
Oficio:	Materia Prima:		
Técnica:			



Proceso de Producción:

Observaciones:

Responsable:	Fecha:
--------------	--------

Referente(s)

- Muestra
 Línea
 Empaque

	FORMATO Ficha de Dibujo y Planos Técnicos	CODIGO: FORASD 07 FECHA: 2004 06 04		
		VERSION 1	Página 1 de 2	

Subgerencia de Desarrollo - Centro de Diseño para la Artesanía y las Pymes

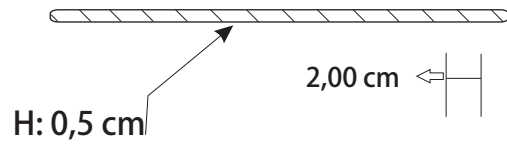
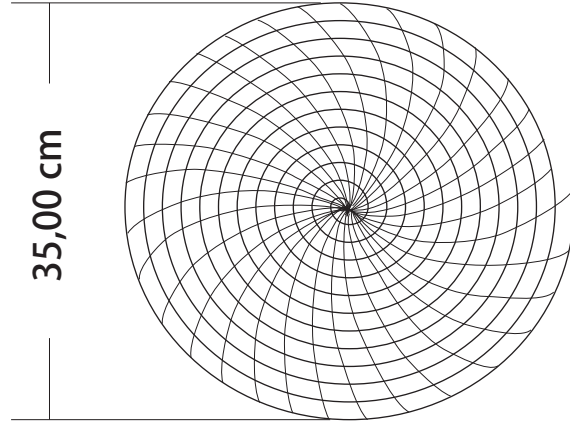
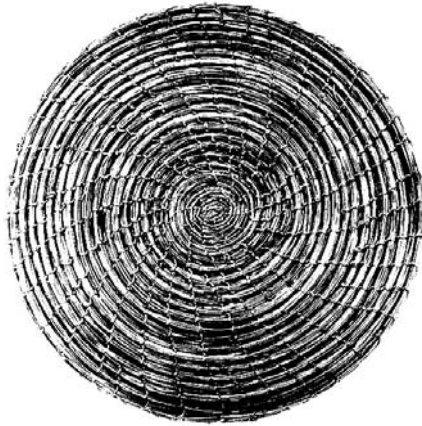

Pieza:	Línea:	ESC. (Cm):	PL.
Nombre:	Referencia:		
Oficio:	Materia Prima:		
Técnica:			



Proceso de Producción:

Observaciones:

Responsable:	Fecha:
--------------	--------

Referente(s)

- Muestra
 Línea
 Empaque

	FORMATO Ficha de Dibujo y Planos Técnicos	CODIGO: FORASD 07 FECHA: 2004 06 04	 
		VERSION 1	Página 1 de 2

Subgerencia de Desarrollo - Centro de Diseño para la Artesanía y las Pymes

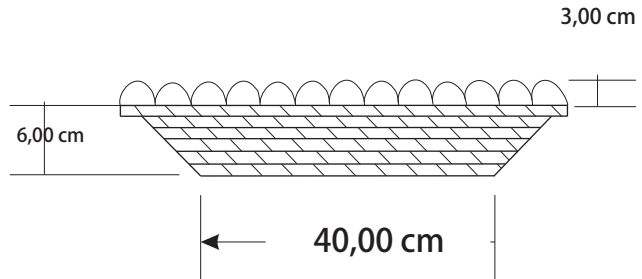
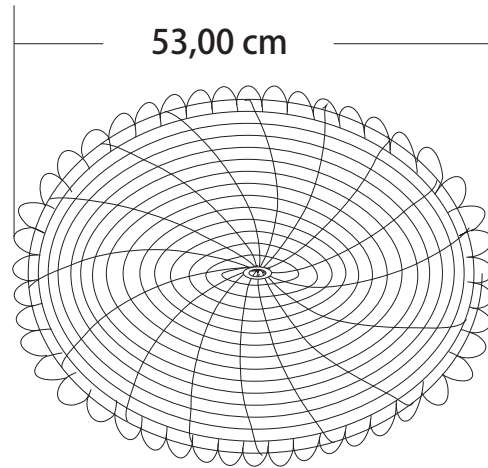
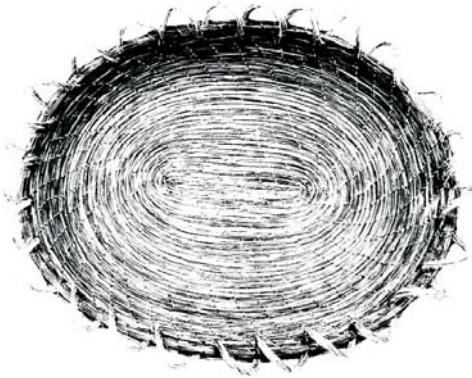

Pieza:	Línea:	ESC. (Cm):	PL.
Nombre:	Referencia:		
Oficio:	Materia Prima:		
Técnica:			



Proceso de Producción:

Observaciones:

Responsable: _____ Fecha: _____

Referente(s)

- Muestra
 Línea
 Empaque

	FORMATO Ficha de Dibujo y Planos Técnicos	CODIGO: FORASD 07 FECHA: 2004 06 04	 
		VERSION 1	Página 1 de 2

Subgerencia de Desarrollo - Centro de Diseño para la Artesanía y las Pymes

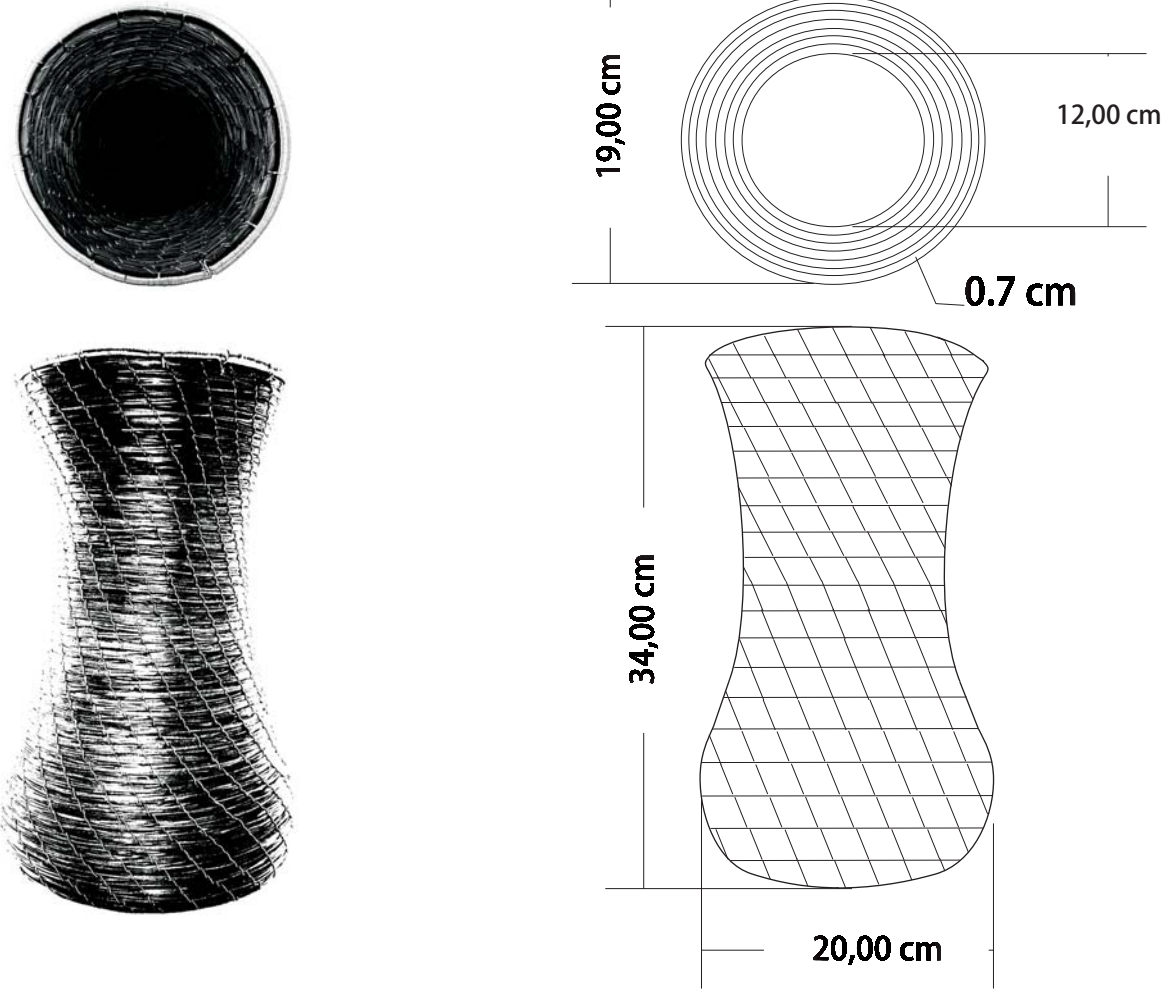

Pieza:	Línea:	ESC. (Cm):	PL.
Nombre:	Referencia:		
Oficio:	Materia Prima:		
Técnica:			



Proceso de Producción:

Observaciones:

Responsable: _____ Fecha: _____

Referente(s)

- Muestra
 Línea
 Empaque

	FORMATO Ficha de Dibujo y Planos Técnicos	CODIGO: FORASD 07 FECHA: 2004 06 04		
		VERSION 1	Página 1 de 2	

Subgerencia de Desarrollo - Centro de Diseño para la Artesanía y las Pymes

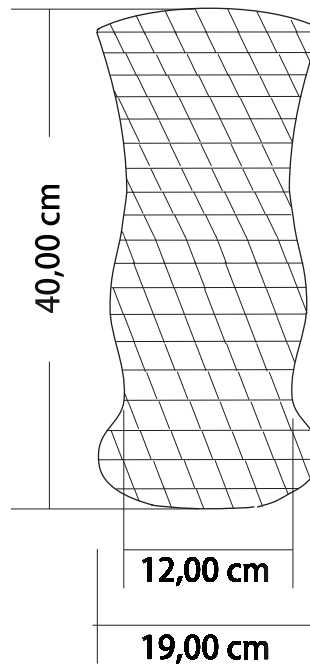
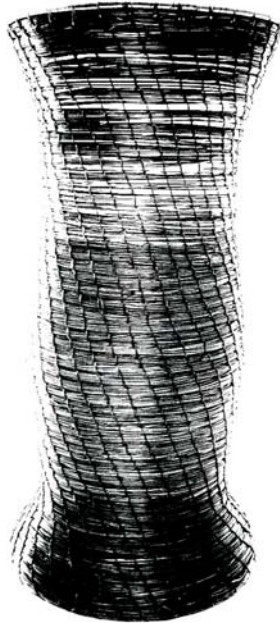
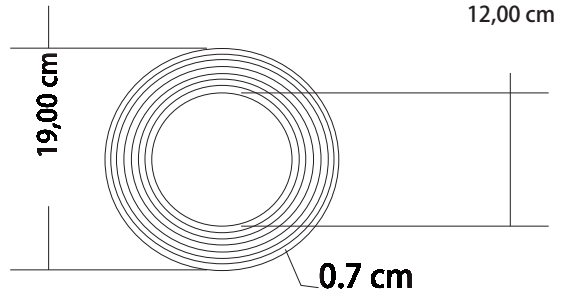

Pieza:	Línea:	ESC. (Cm):	PL.
Nombre:	Referencia:		
Oficio:	Materia Prima:		
Técnica:			

Proceso de Producción:

Observaciones:

Responsable:	Fecha:
--------------	--------

Referente(s)

- Muestra
 Línea
 Empaque