



Formulario de programas y proyectos



Fortalecimiento de los procesos artesanales productivos y culturales de las mujeres artesanas del departamento de Nariño

Proyecto formulado en el contexto del convenio interinstitucional suscrito entre Artesanías de Colombia y la Gobernación del departamento de Nariño

Hilando Redes Humanas de Vida

Diseño de bocetos de productos de los municipios nariñenses de Cartago, La Florida, Guachaez y El Tablón



María Ximena Castro Delgado
asesora

Gobernación de Nariño
Laboratorio Artesanías De Colombia –Nariño
Pasto, 2014

M.LA FLORIDA

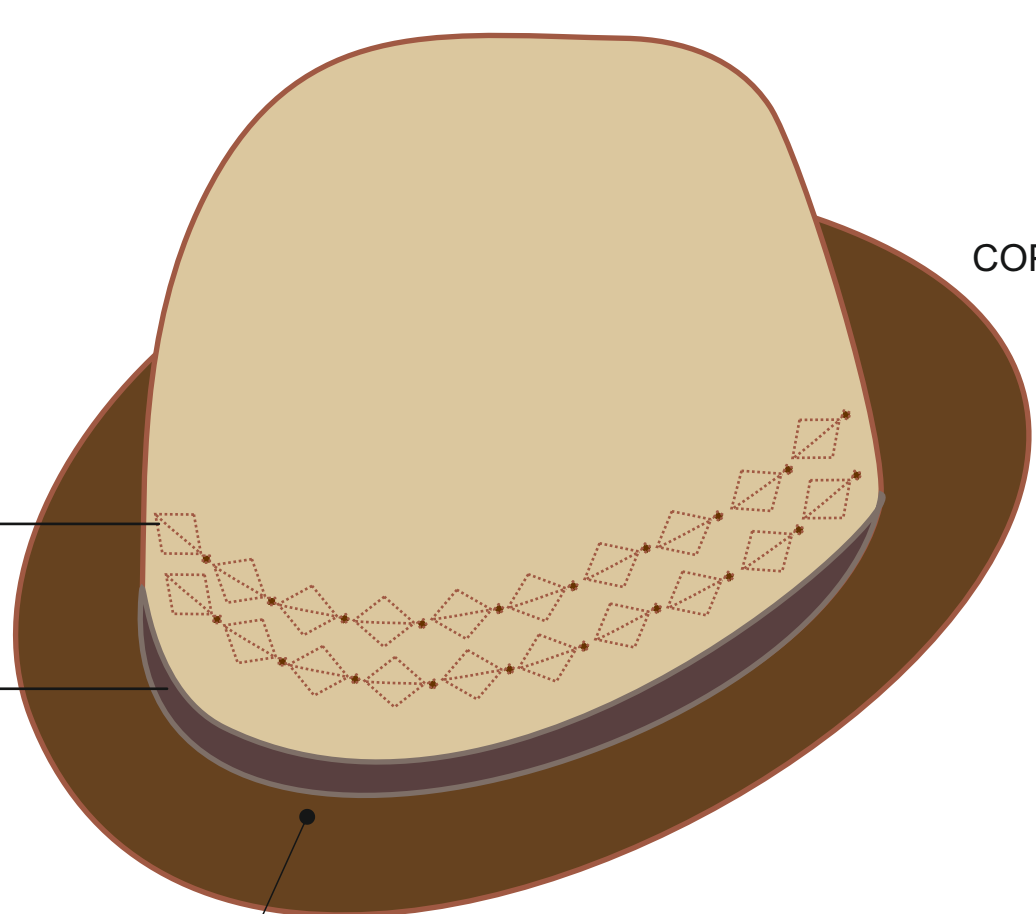

Calado
 CUERO ATERCIOPELADO
 57X 1CM

5 cm
 ALA

Tejido en paja fina Cambio de
 pajas de color beige a café oscuro
 tipo de tejido granizo .

Ficha Técnica

Laboratorio

Sombreros

Línea

Sombrero hombre

Producto

Pieza

COPA 9 cm

Materias Primas

Paja toquilla, cuero aterciopelado

Paleta de Color



\$ 82000

Costo

Fecha

Boceto 1 de 1

Laboratorio

Sombreros

Línea

Sombrero dama

Producto

Pieza

Materias Primas

paja toquilla, cuero aterciopelado

Paleta de Color



\$ 82000

Costo

Fecha

Boceto 1 de 1

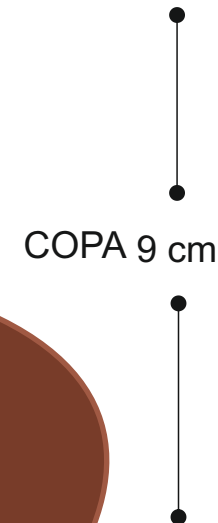
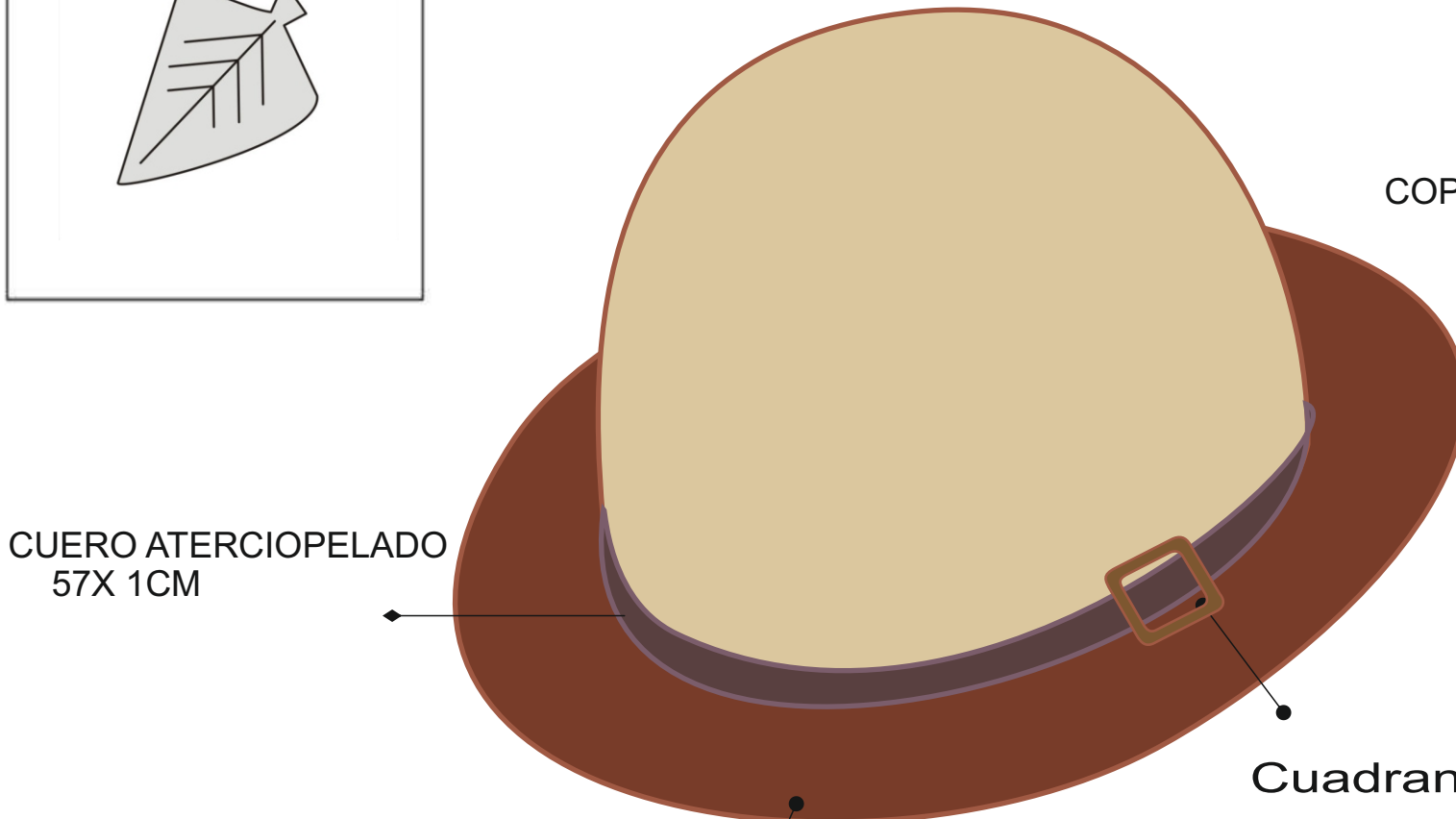

CUERO ATERCIOPELADO
57X 1CM

Cuadrante

5 cm
ALA

Tejido en paja fina Cambio de pajas de color beige a café oscuro tipo de tejido granizo .

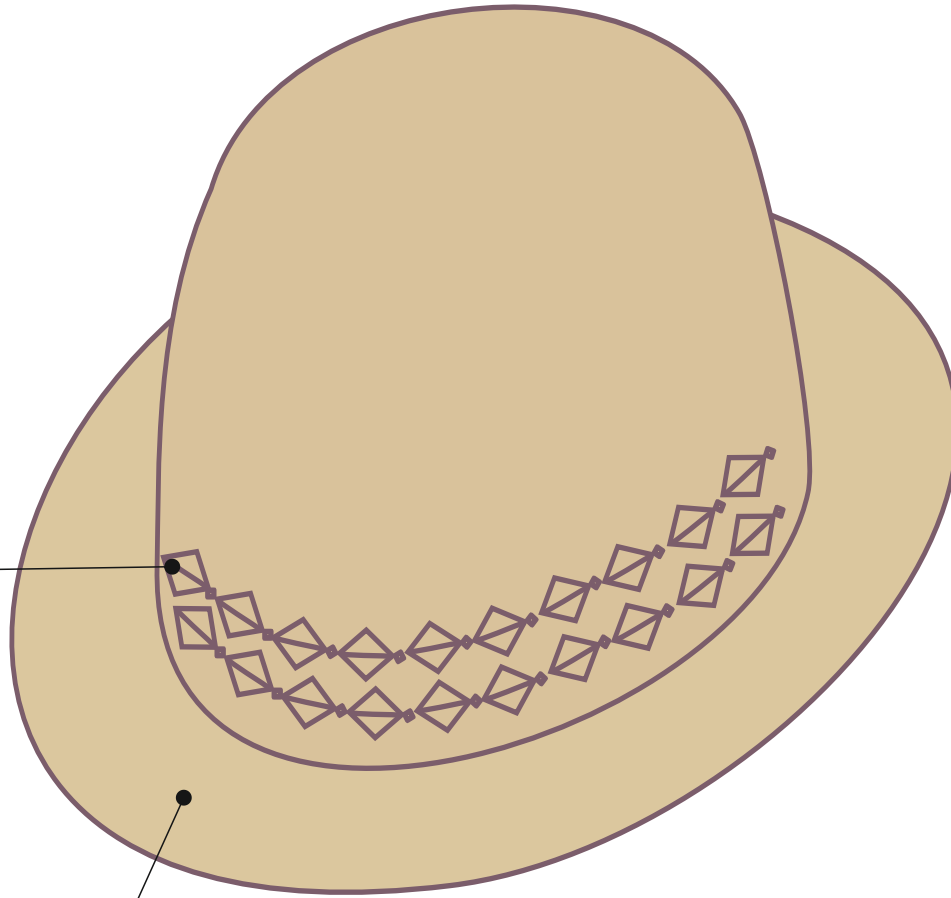

Calado

4 cm
ALA

Tejido en paja fina un solo color
tipo de tejido granizo .

COPA 9 cm

Ficha Técnica

Laboratorio

Sombreros

Línea

Sombrero niño

Producto

Pieza

Materias Primas

Paja toquilla

Paleta de Color



\$ 35000

Costo

Fecha

Boceto 1 de 1

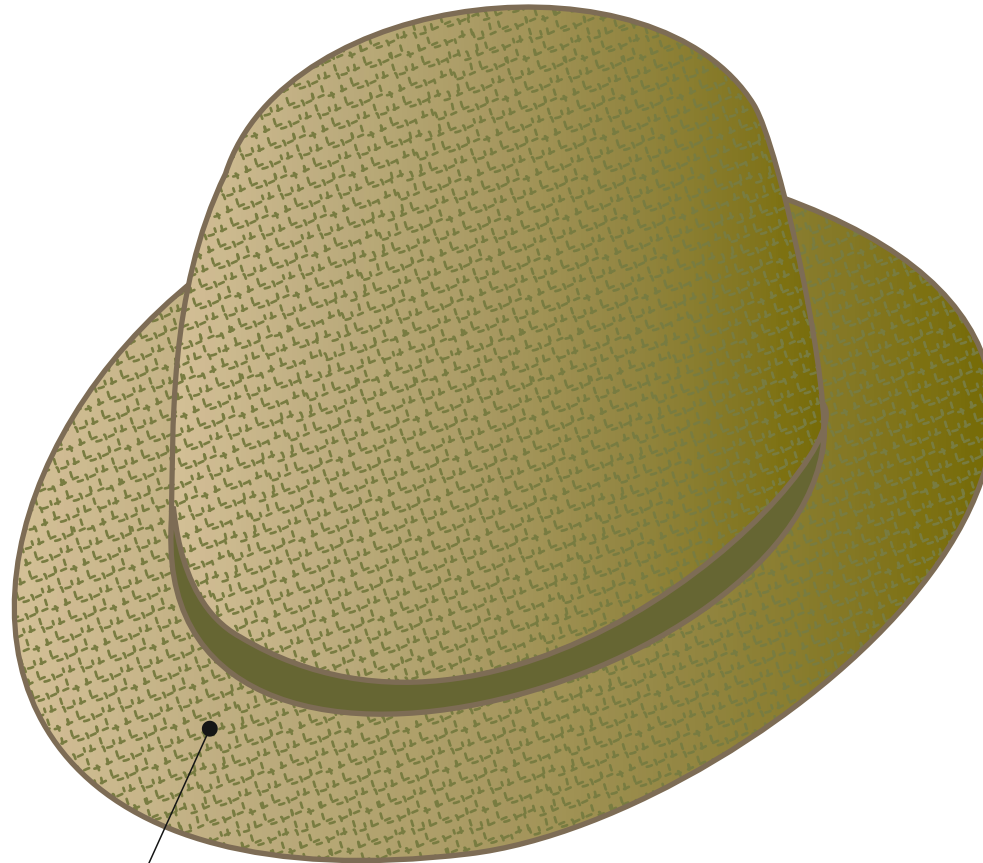

6 cm
ALA

Tejido en paja fina con doble fibra color beige y verde oliva tipo de tejido granizo doble color .

COPA 8 cm

Ficha Técnica

Laboratorio

Sombreros

Línea

Pava niña

Producto

Pieza

Materias Primas

Paja toquilla, cuero aterciopelado

Paleta de Color

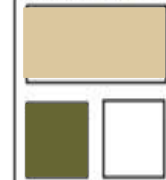

\$ 35000

Costo

Fecha

Boceto 1 de 1

Laboratorio

Contenedores

Línea

Contenedor 1

Producto

Pieza

Materias Primas

Paja toquilla, Cuero

Paleta de Color



\$30000

Costo

Fecha

Boceto 1 de 1

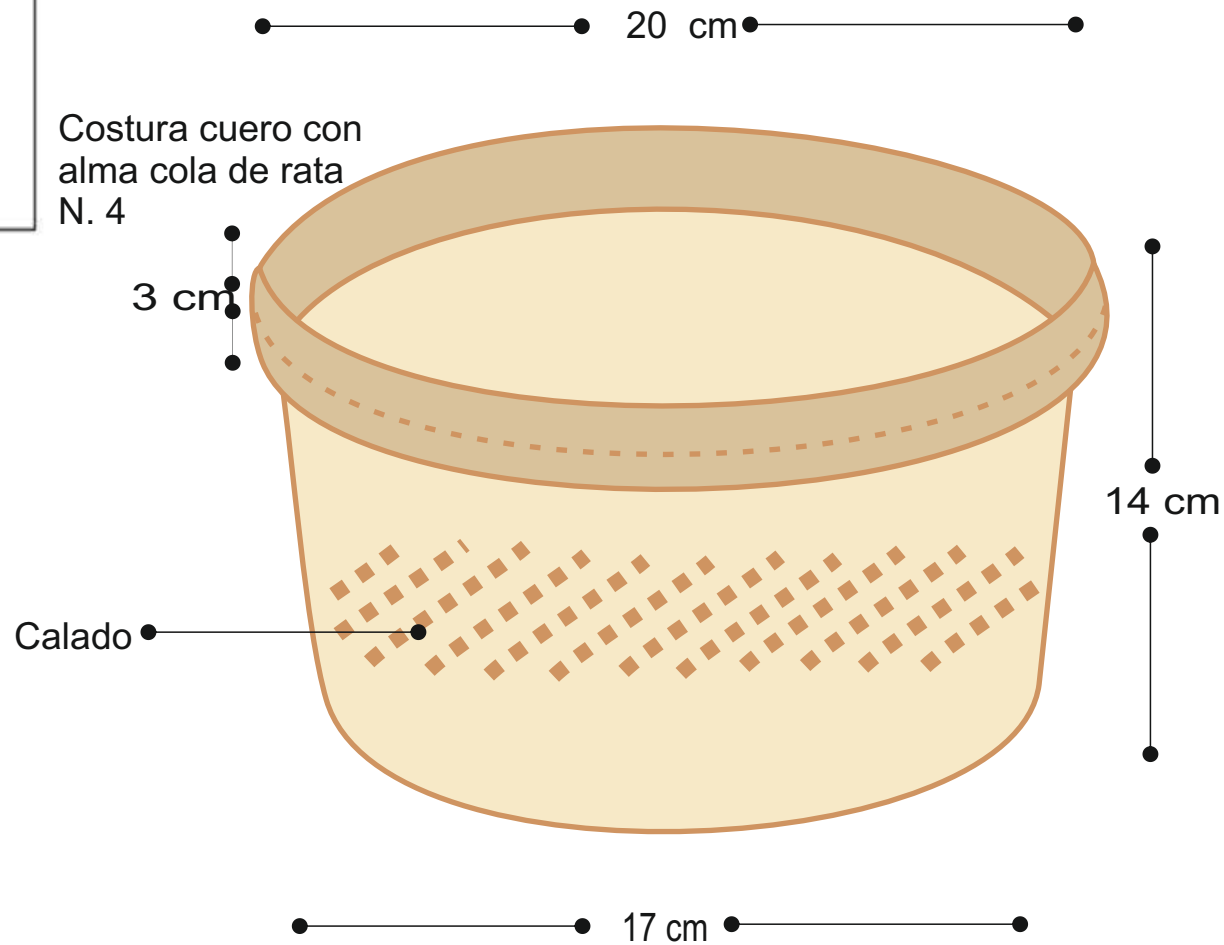
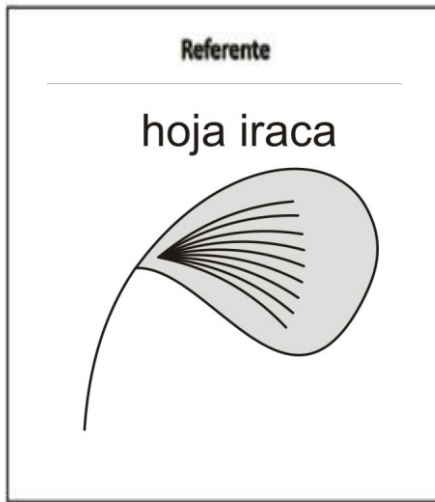

Costura cuero con
 alma cola de rata
 N. 4

Tejido en paja gruesa, tipo de tejido granizo .

Ficha Técnica

Laboratorio

Contenedores

Línea

Contenedor 2

Producto

Pieza

Materias Primas

Paja toquilla,
Cuero

Paleta de Color



\$30000

Costo

Fecha

Boceto 1 de 1



Costura cuero con
alma cola de rata
N. 4

3 cm

Calado

20 cm

14 cm

17 cm

Tejido en paja gruesa, tipo de tejido granizo .

Laboratorio

Contenedores

Línea

Contenedor 3

Producto

Pieza

Materias Primas

Paja toquilla, Cuero

Paleta de Color

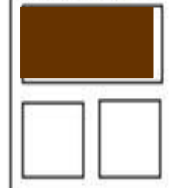

\$30000

Costo

Fecha

Boceto 1 de 1

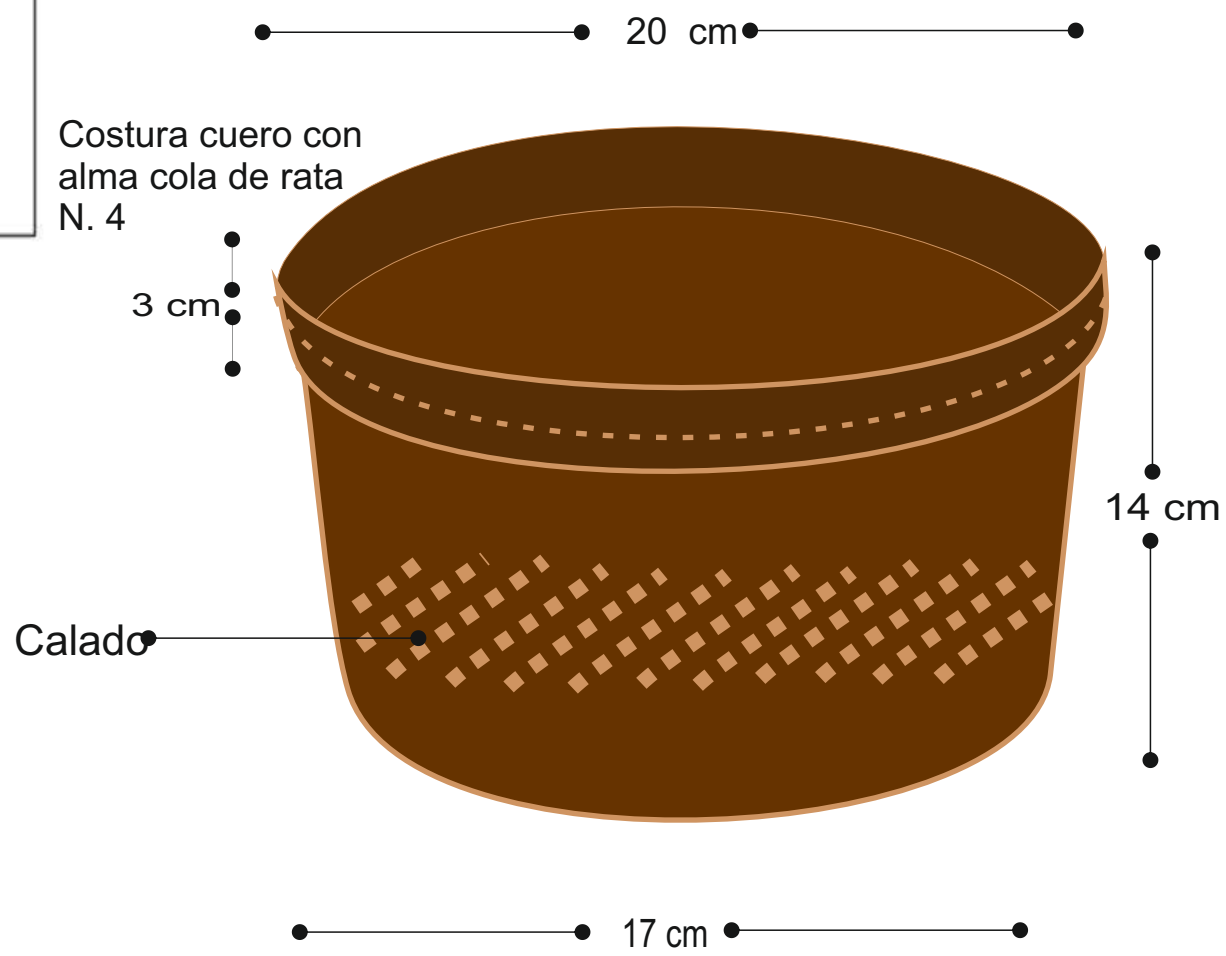
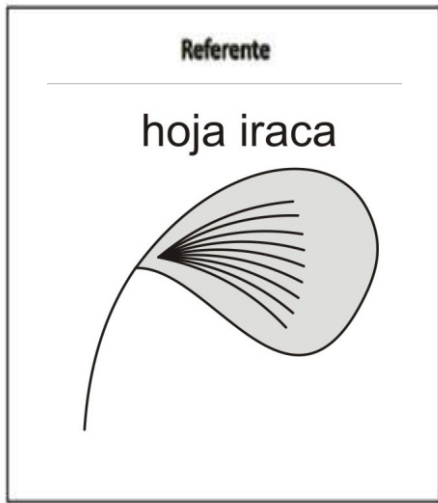

Costura cuero con
 alma cola de rata
 N. 4

Tejido en paja gruesa, tipo de tejido granizo .

Laboratorio

Mesa

Línea

Individual

Producto

Pieza

Materias Primas

Paja toquilla

Paleta de Color

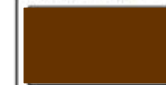

\$ 15000 Unidad

Costo

Fecha

Boceto 1 de 1

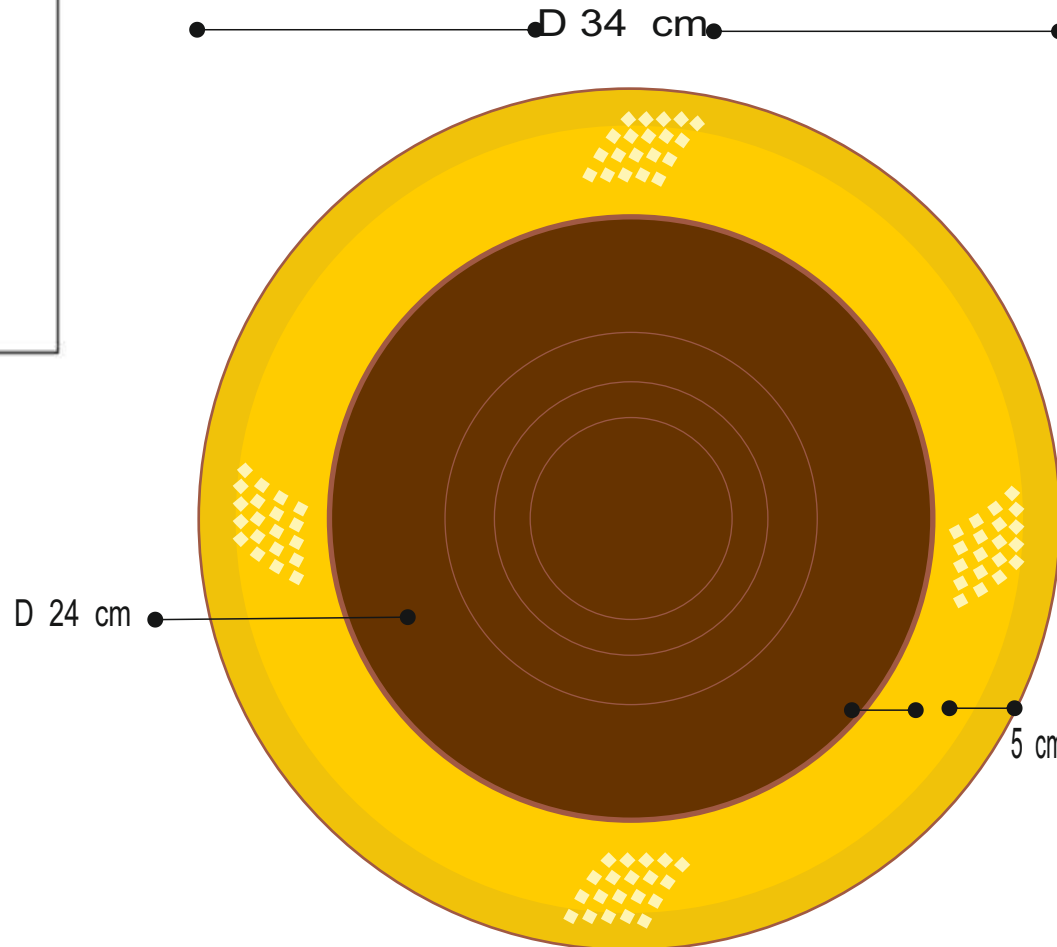
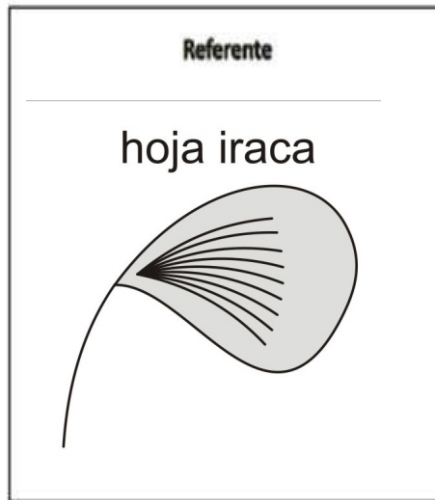

Tejido en paja gruesa con cambio de pajas de color cafe a amarillo, tipo de tejido granizo.

Laboratorio

Mesa

Línea

Individual

Producto

Pieza

Materias Primas

Paja toquilla

Paleta de Color



\$ 15000 unidad

Costo

Fecha

Boceto 1 de 1

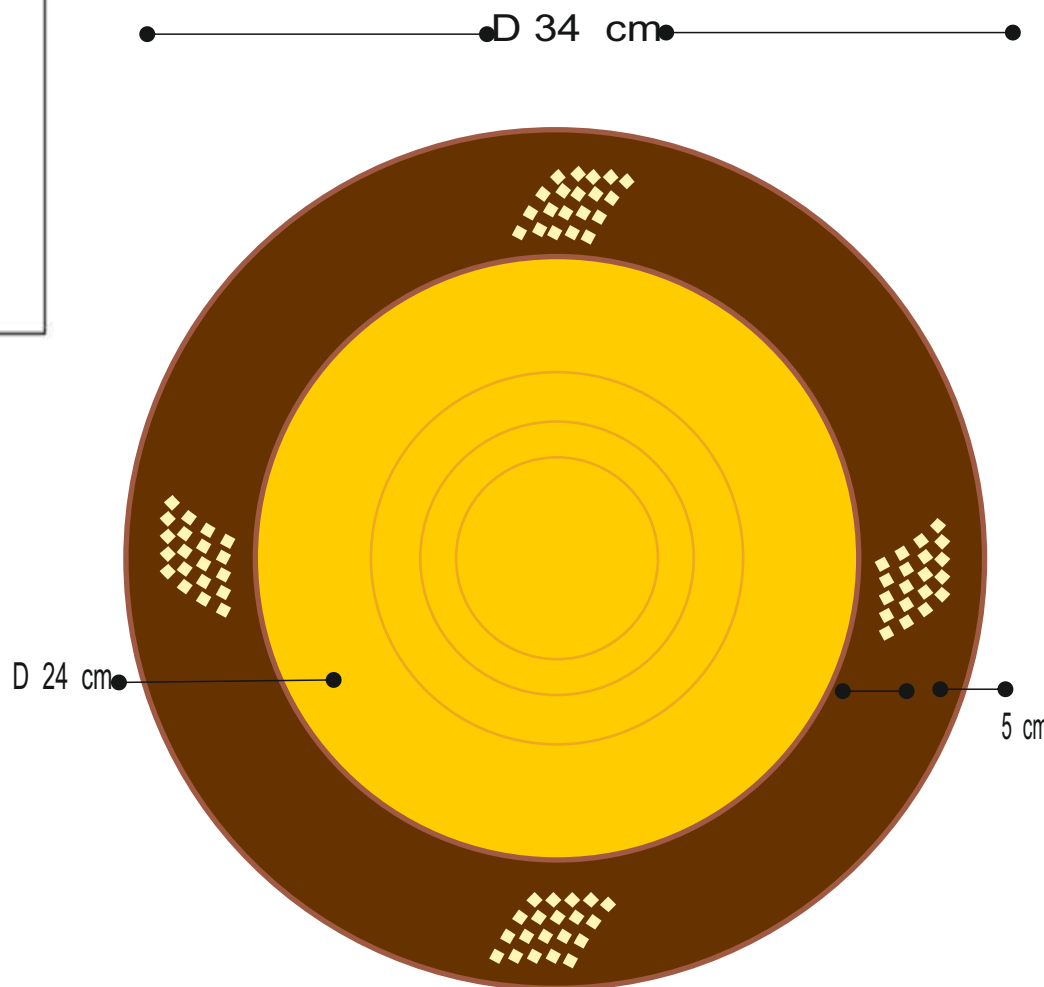
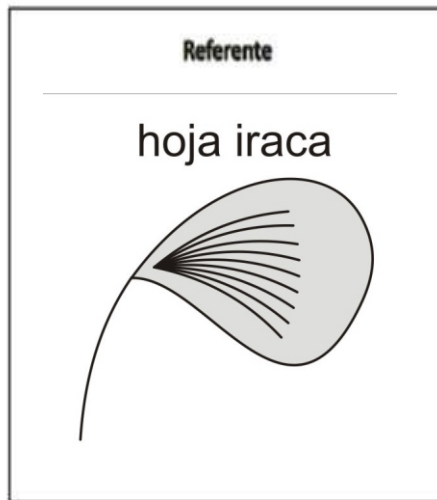

Tejido en paja gruesa con cambio de pajas de color amarillo a café ,tipo de tejido granizo.

Ficha Técnica

Laboratorio

Mesa

Línea

Juego individuales

Producto

Pieza

Materias Primas

Paja toquilla

Paleta de Color



\$ 60000

Costo

Fecha

Boceto 1 de 1

Referente

hoja iraca

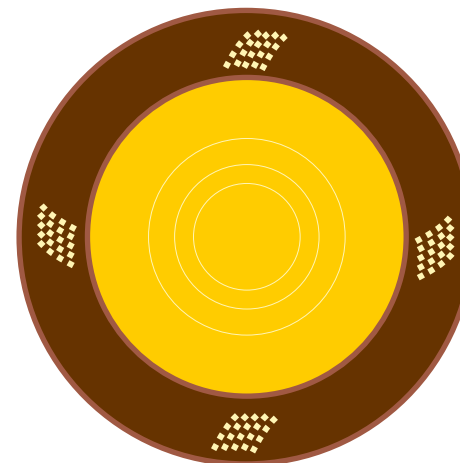
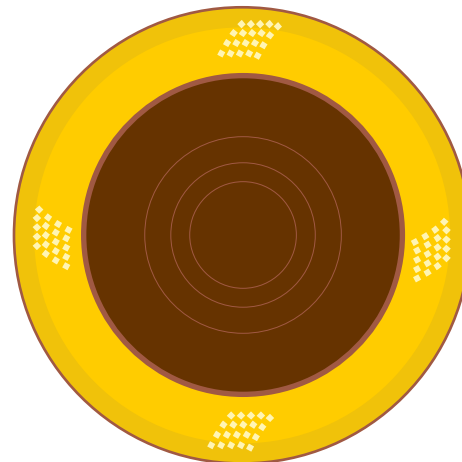
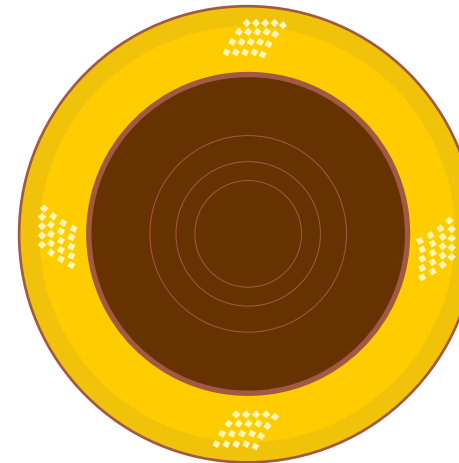
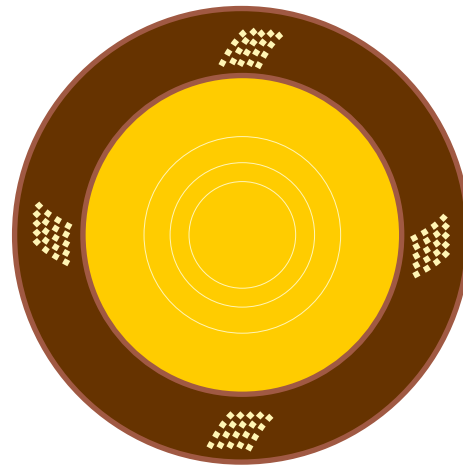
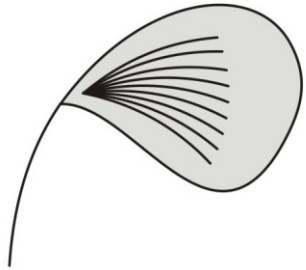

Laboratorio

Mesa

Línea

Bandeja

Producto

Pieza

Materias Primas

Paja toquilla, arcilla

Paleta de Color



\$ 35000

Costo

Fecha

Boceto 1 de 1

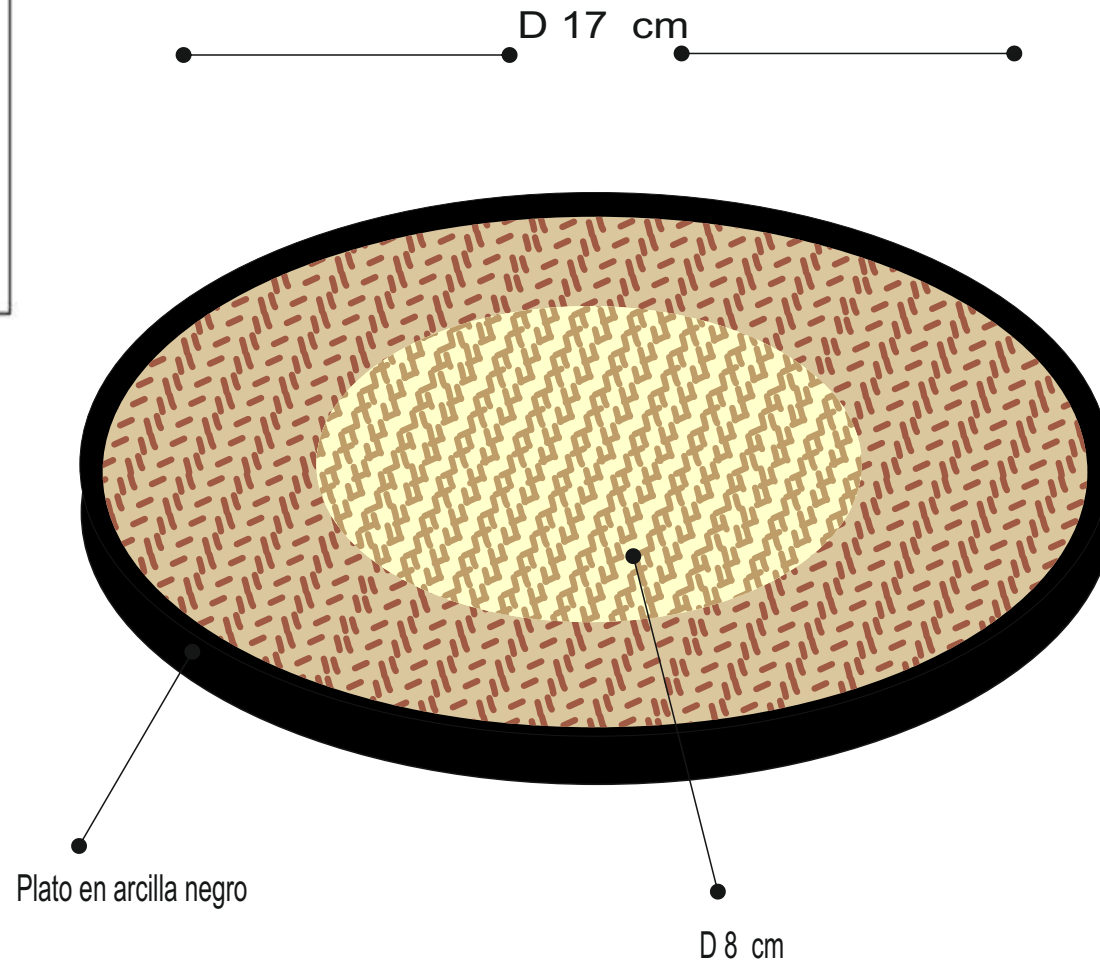
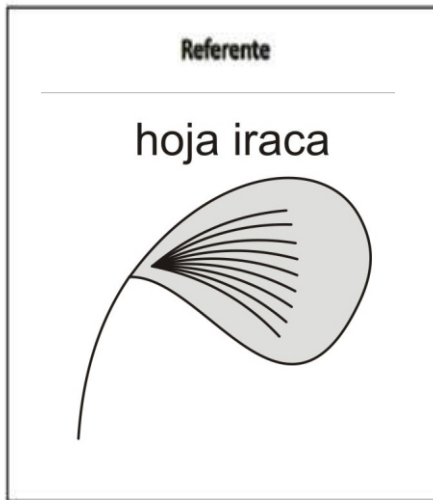

Tejido en paja gruesa en dos colores.

**M.TABLON
DE GOMEZ**

Ficha Técnica

Laboratorio

Bolsos

Línea

Mochila 1

Producto

Pieza

Materias Primas

Hilo líder

Paleta de Color

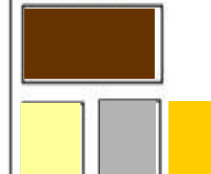

\$80000

Costo

Fecha

Boceto 1 de 1

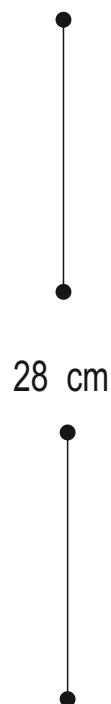
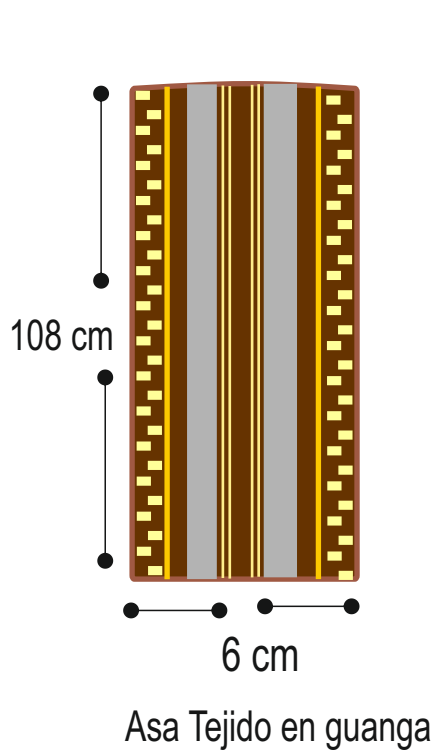
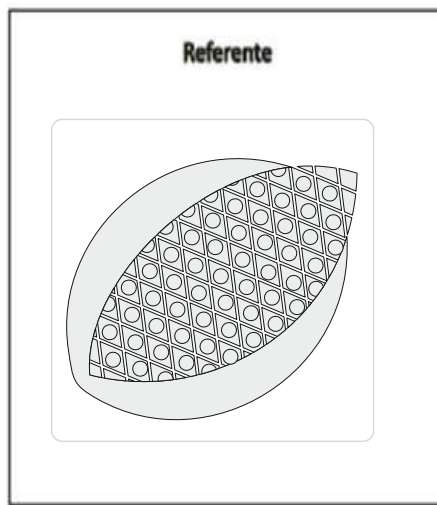

Circulo base 20 cm

Ficha Técnica

Laboratorio

Bolsos

Línea

Mochila 2

Producto

Pieza

Materias Primas

Hilo lider,

Paleta de Color



\$66000

Costo

Fecha

Boceto 1 de 1

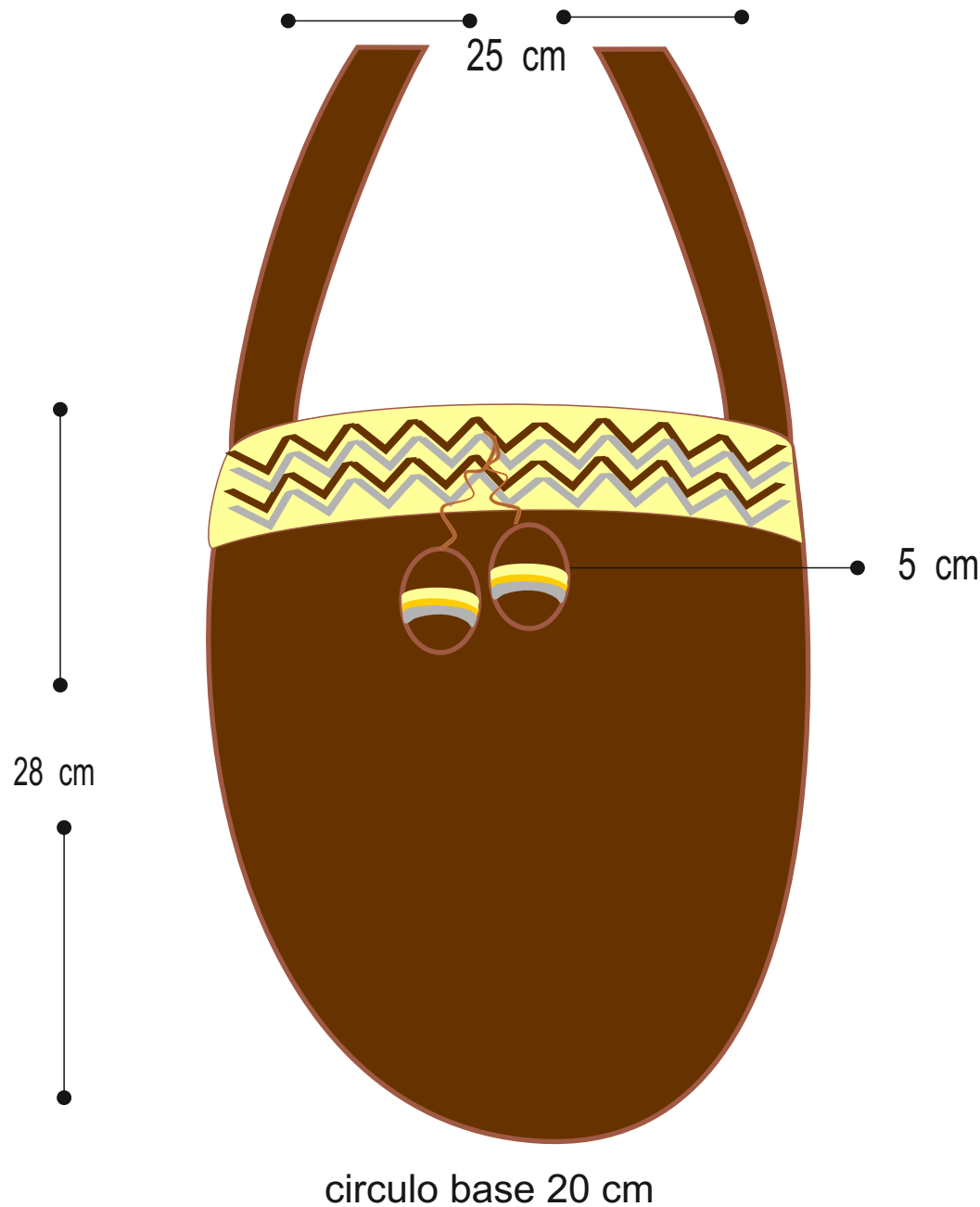
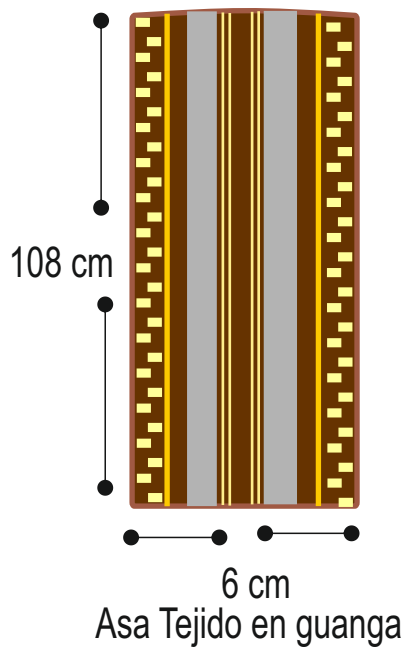
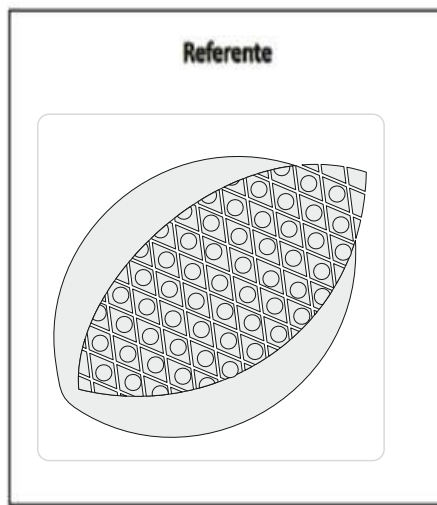

Ficha Técnica

Laboratorio

Bolsos

Línea

Mochila 3

Producto

Pieza

Materias Primas

Hilo Líder

Paleta de Color

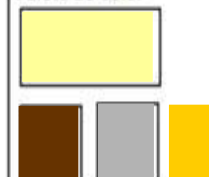

\$80000

Costo

Fecha

Boceto 1 de 1

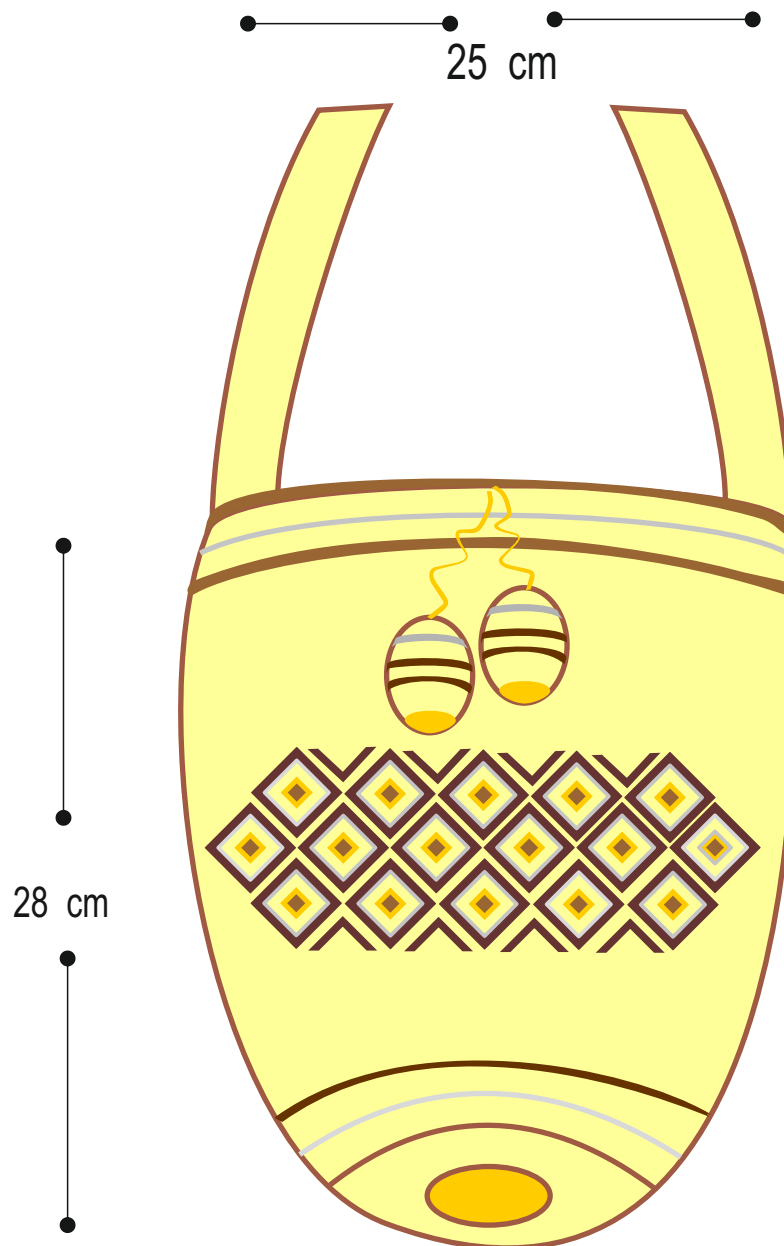
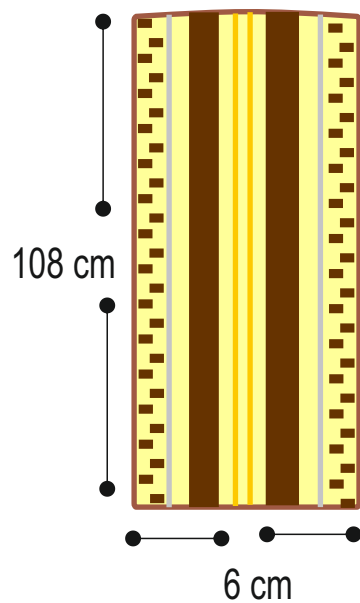
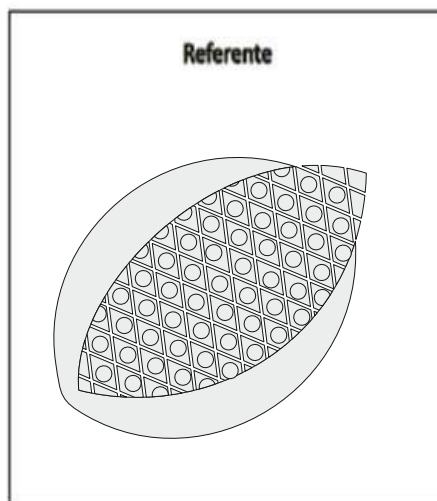

Circulo base 20 cm

Ficha Técnica

Laboratorio

Contenedores

Línea

Contenedor 1

Producto

Pieza

Materias Primas

Hilo guajiro,
alambre
galvanizado

Paleta de Color

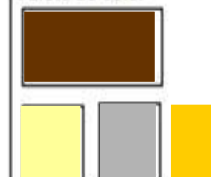

\$66000

Costo

Fecha

Boceto 1 de 1

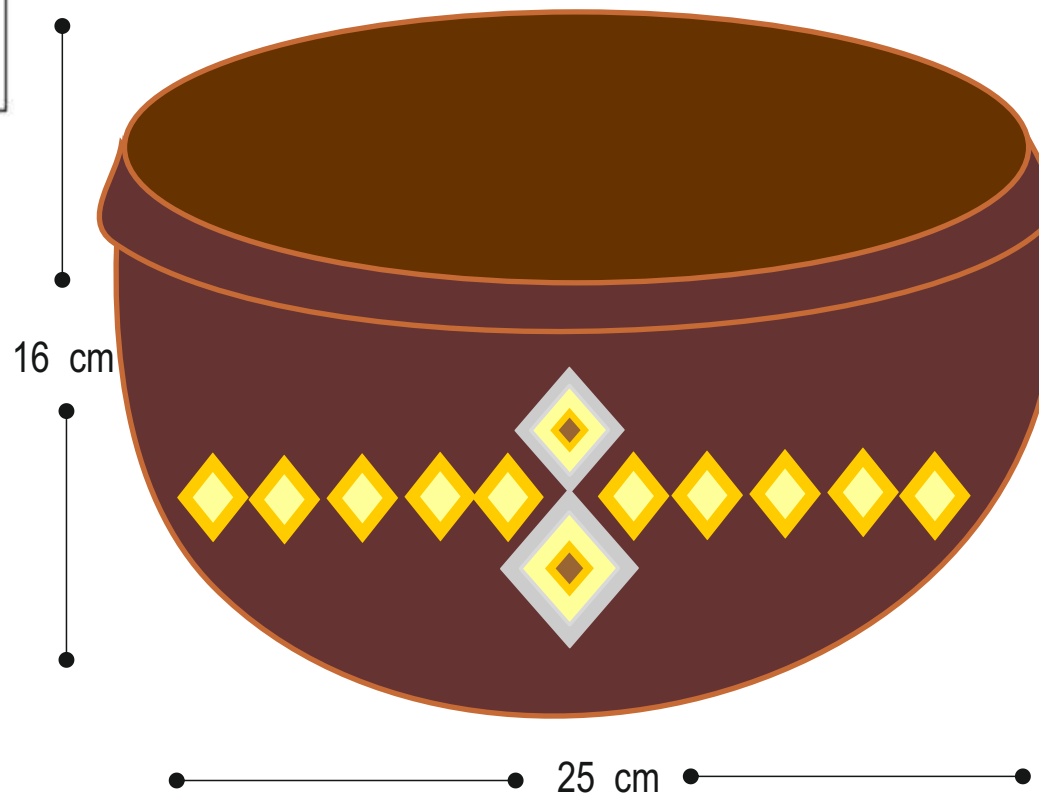
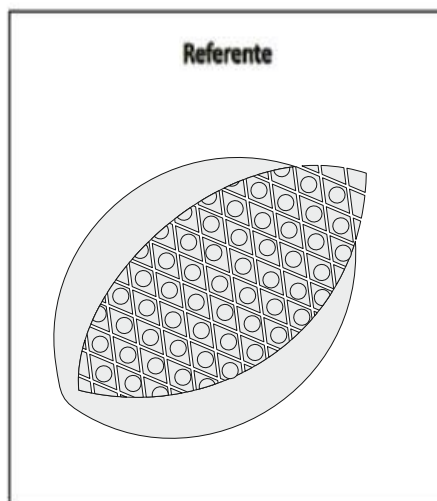

Ficha Técnica

Laboratorio

Contenedores

Línea

Contenedor 2

Producto

Pieza

Materias Primas

Hilo guajiro,
alambre
galvanizado

Paleta de Color

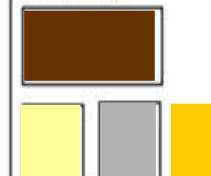

\$66000

Costo

Fecha

Boceto 1 de 1

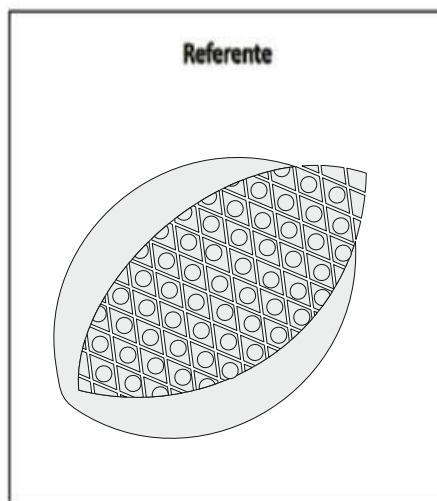

16 cm



16 cm

25 cm

Ficha Técnica

Laboratorio

Contenedores

Línea

Contenedor 3

Producto

Pieza

Materias Primas

Hilo guajiro,
alambre
galvanizado

Paleta de Color



\$66000

Costo

Fecha

Boceto 1 de 1

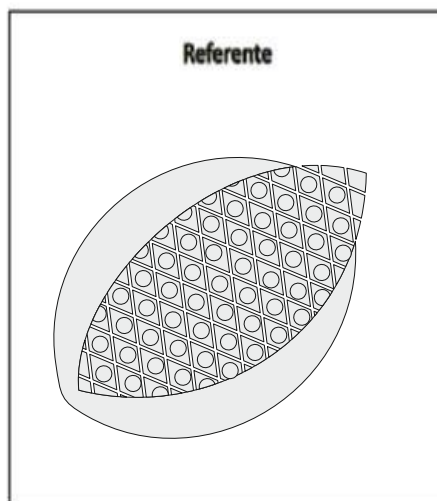

16 cm

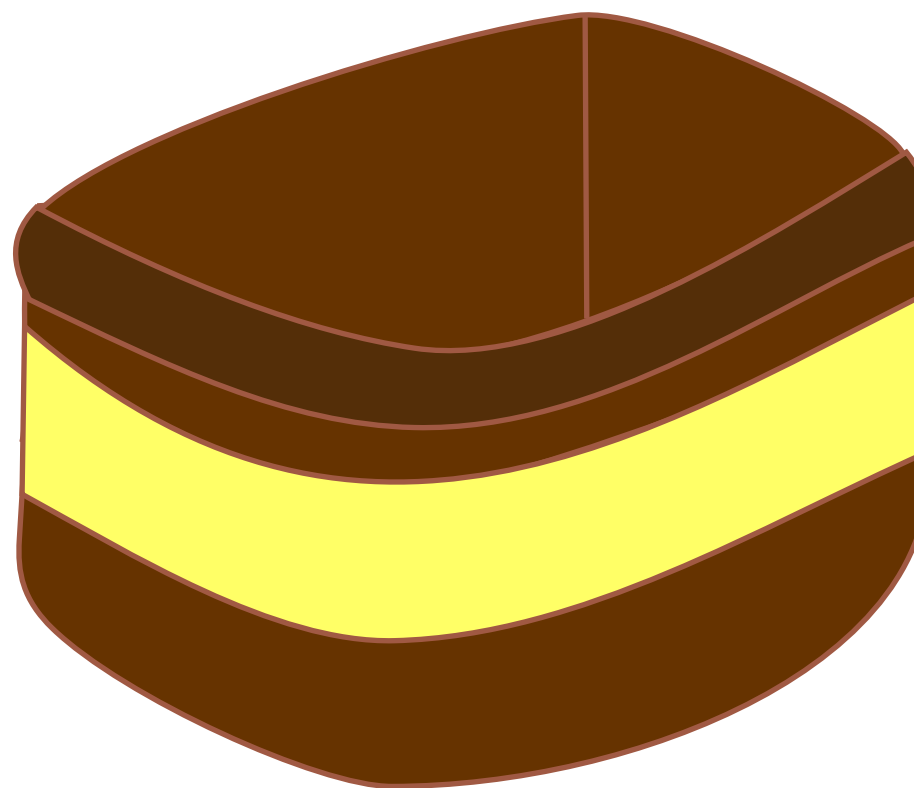

25 cm

Ficha Técnica

Laboratorio

Home decor

Línea

Cojin

Producto

Pieza

Materias Primas

Hilo lider

Paleta de Color

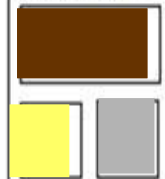

\$56000

Costo

Fecha

Boceto 1 de 1

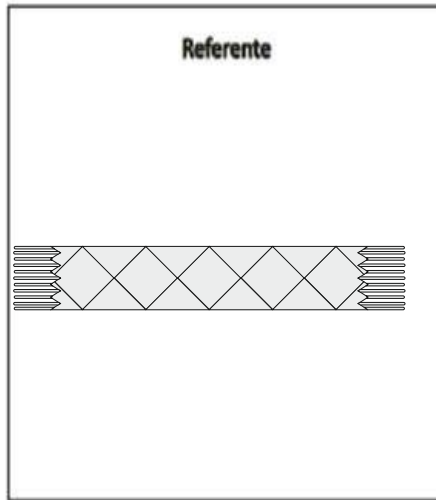

Referente

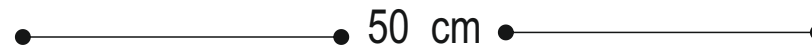
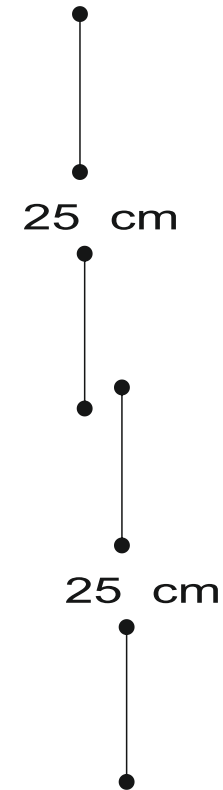
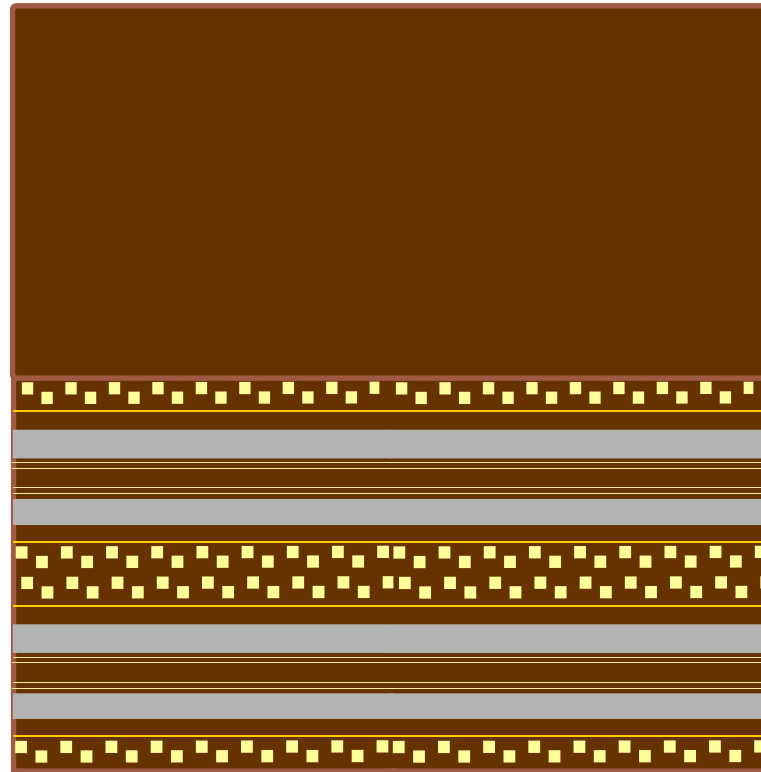
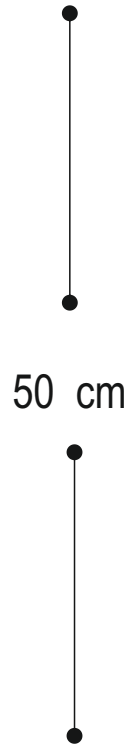

Tejido en Guanga

Ficha Técnica

Laboratorio

Home decor

Línea

Camino de mesa

Producto

Pieza

Materias Primas

Hilo líder

Paleta de Color



\$45000

Costo

Fecha

Boceto 1 de 1

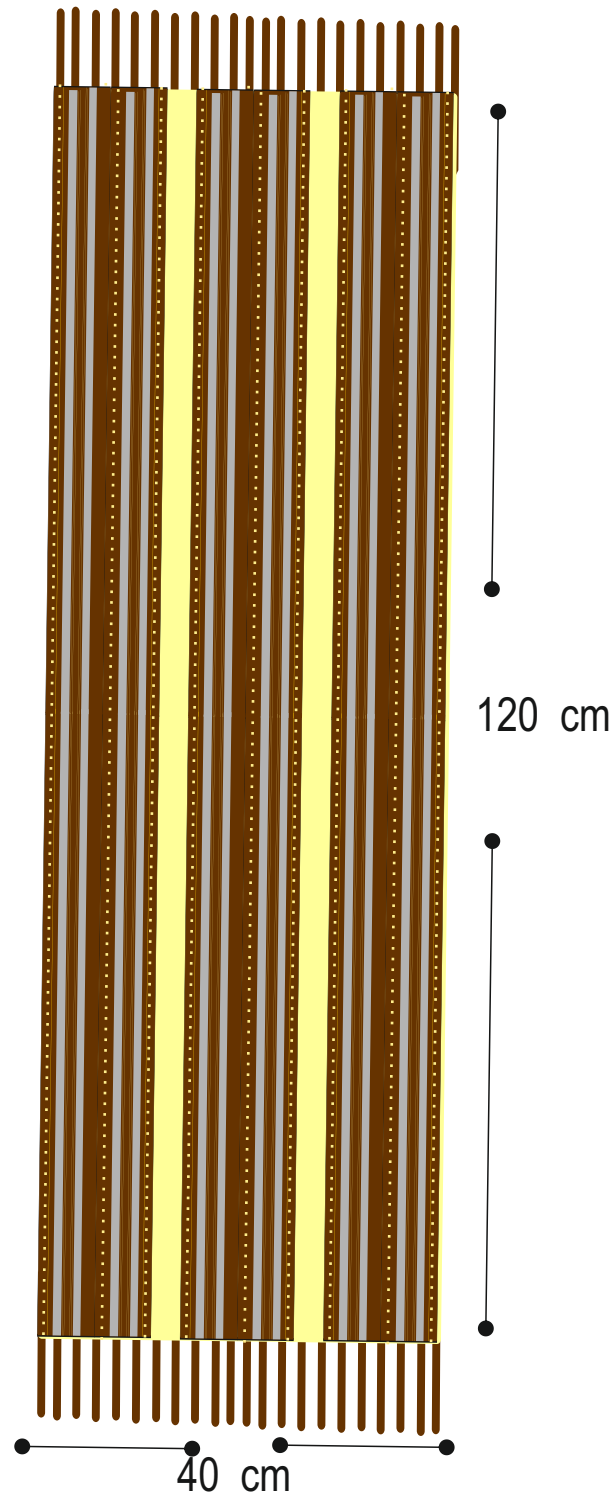
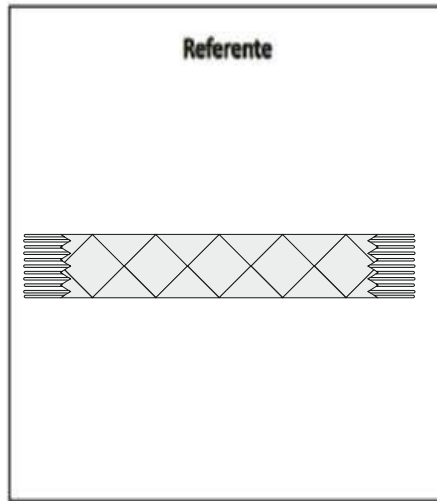

Ficha Técnica

Laboratorio

Accesorios personales

Línea

Bufanda

Producto

Pieza

Materias Primas

Hilo líder

Paleta de Color

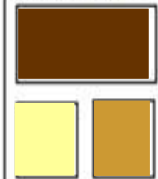

\$35000

Costo

Fecha

Boceto 1 de 1

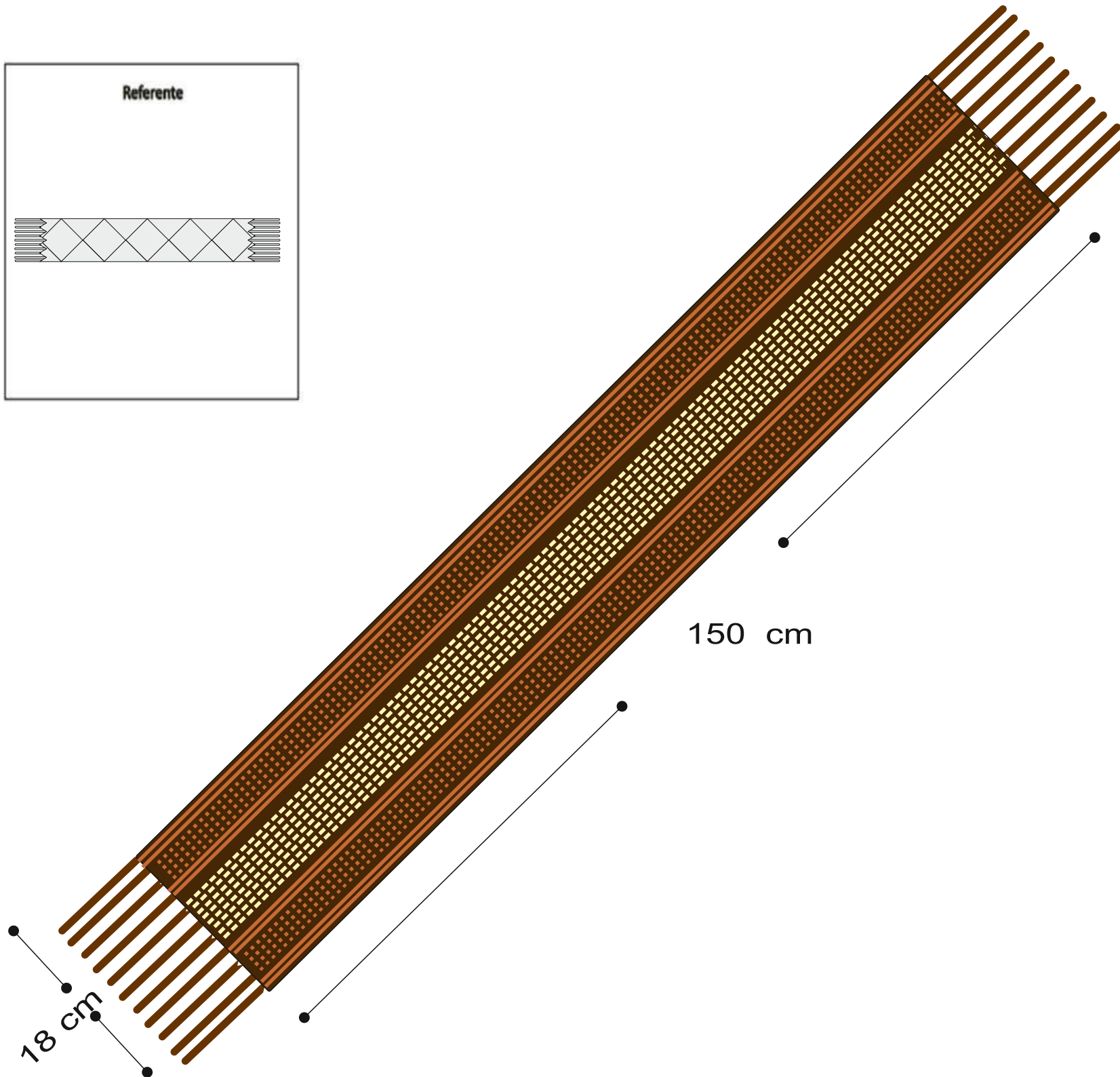
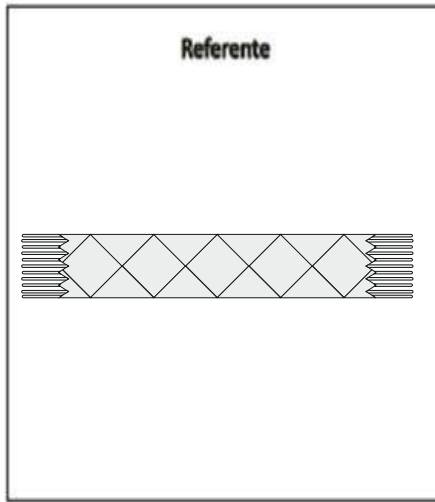

Ficha Técnica

Laboratorio

Accesorios personales

Línea

Accesorio mujer

Producto

Pieza

Materias Primas

Hilo perla

Paleta de Color



\$30000

Costo

Fecha

Boceto 1 de 1

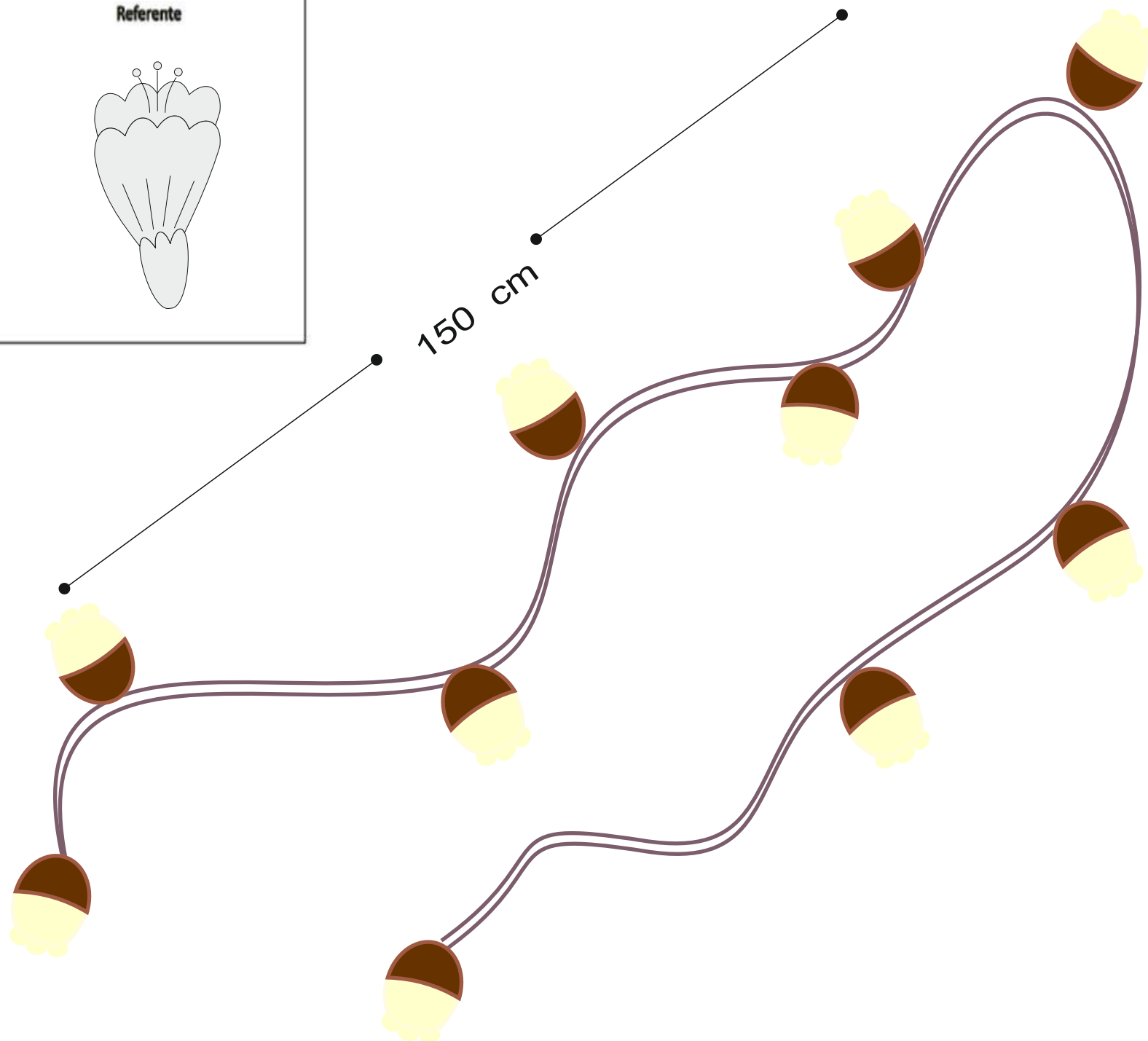
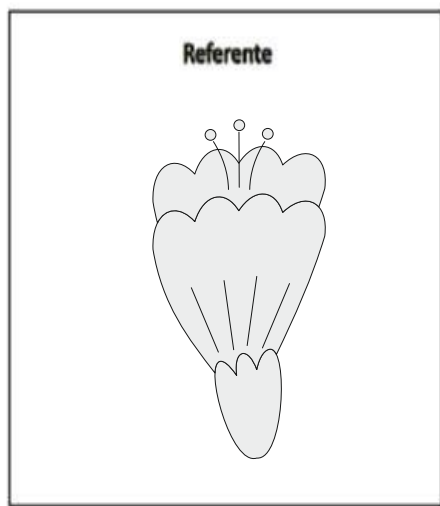

**M.SANTACRUZ
DE GUACHAVEZ**

Ficha Técnica

Laboratorio

Home decor

Línea

Camino de mesa

Producto

Pieza

Materias Primas

Lana bebe, tela aterciopelada

Paleta de Color



\$30000

Costo

Fecha

Boceto 1 de 1

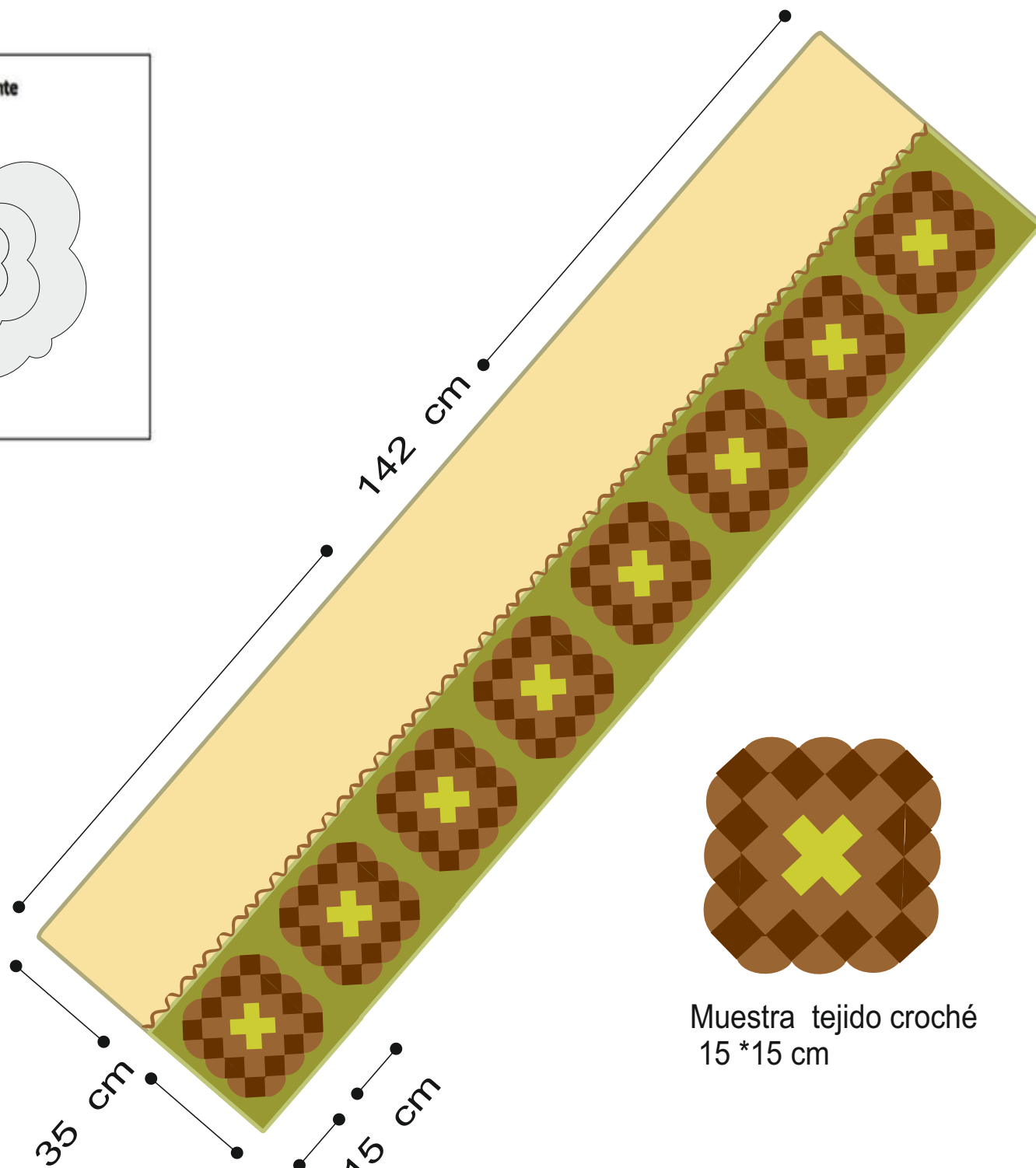
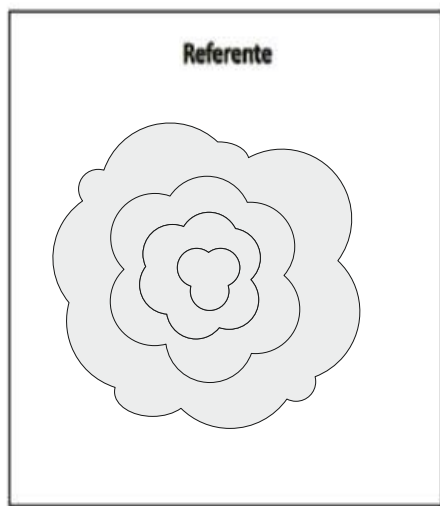

Muestra tejido croché
15 * 15 cm

Ficha Técnica

Laboratorio

Home decor

Línea

Cojín

Producto

Pieza

Materias Primas

Lana bebe, tela
Aterciopelada

Paleta de Color



\$30000

Costo

Fecha

Boceto 1 de 1

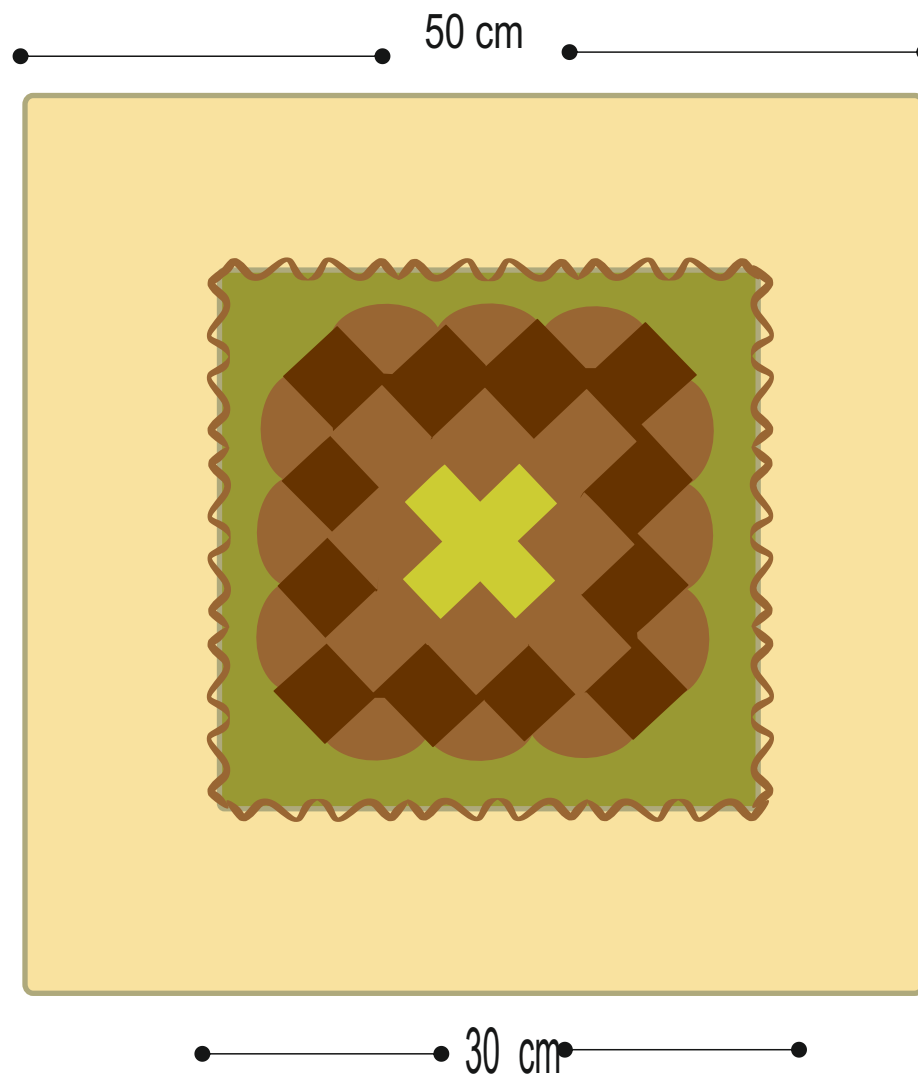
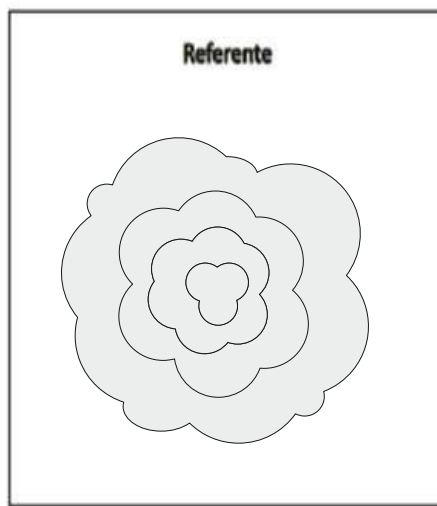

50 cm

30 cm

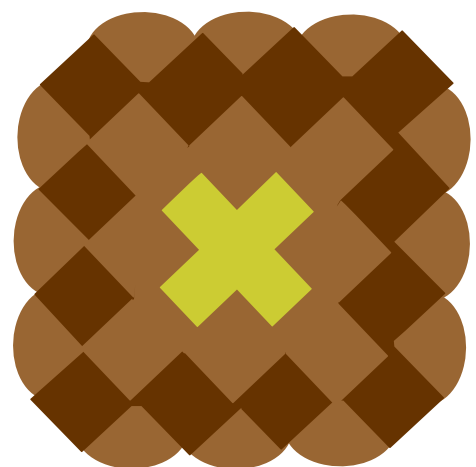

25 cm

Muestra tejido croché 25 *25 cm

Ficha Técnica

Laboratorio

Bolsos

Línea

Bolso playero

Producto

Pieza

Materias Primas

Tela aterciopelada
tela para forro, hilo
lider, guata.

Paleta de Color

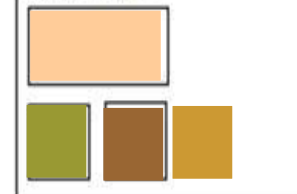

\$40000

Costo

Fecha

Boceto 1 de 1

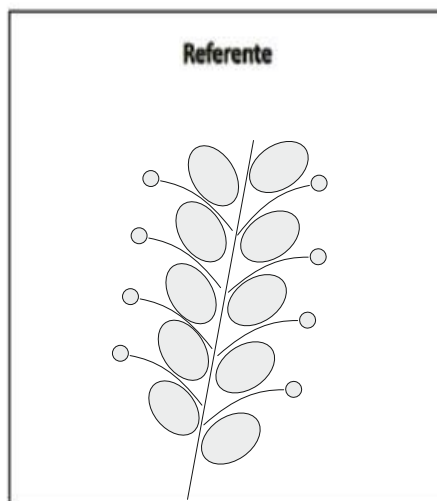

Muestra 5 * 5 cm



Ficha Técnica

Laboratorio

Bolsos

Línea

Bolso playero

Producto

Pieza

Materias Primas

Tela aterciopelada
tela para forro, hilo
lider, guata.

Paleta de Color

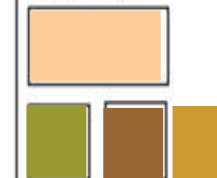

\$40000

Costo

Fecha

Boceto 1 de 1

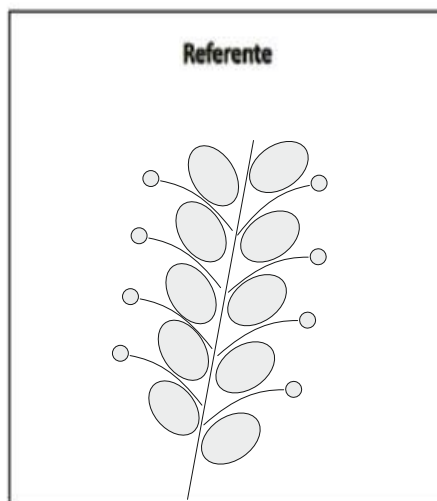

Muestra 5 *5 cm

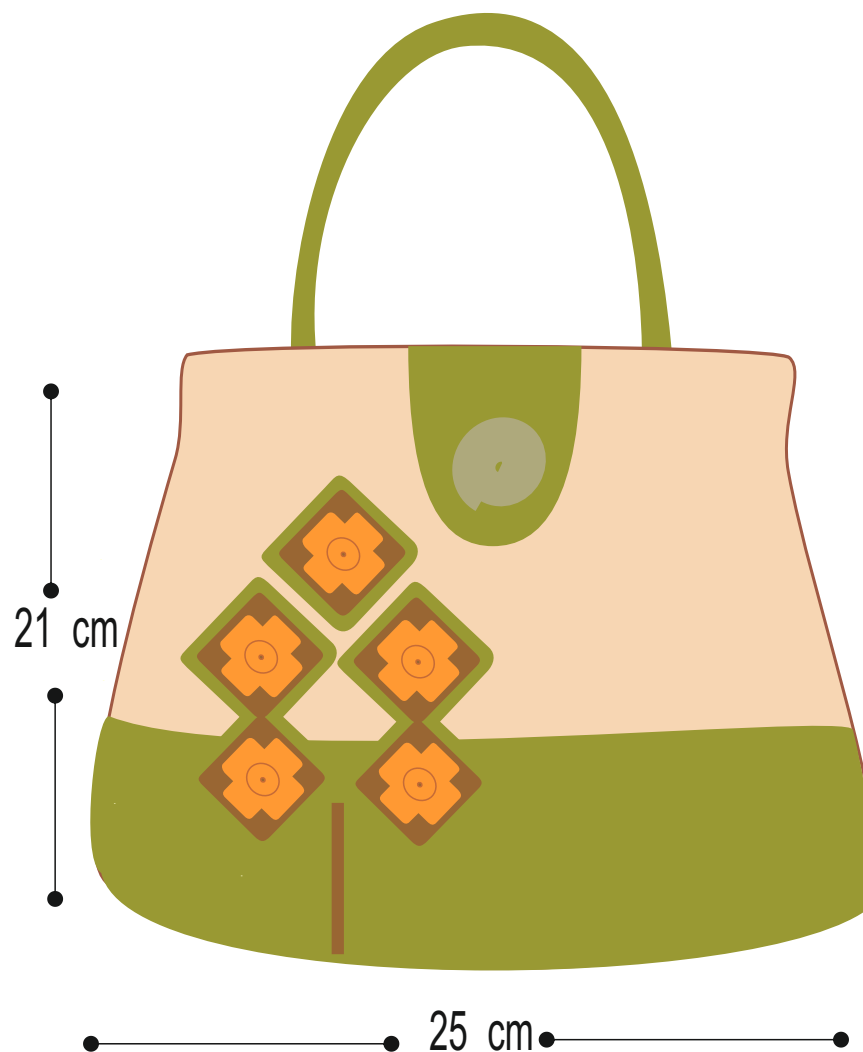

Ficha Técnica

Laboratorio

Bolsos

Línea

Bolso playero

Producto

Pieza

Materias Primas

Tela aterciopelada
tela para forro, hilo
lider, guata.

Paleta de Color

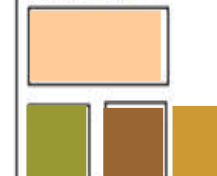

\$40000

Costo

Fecha

Boceto 1 de 1

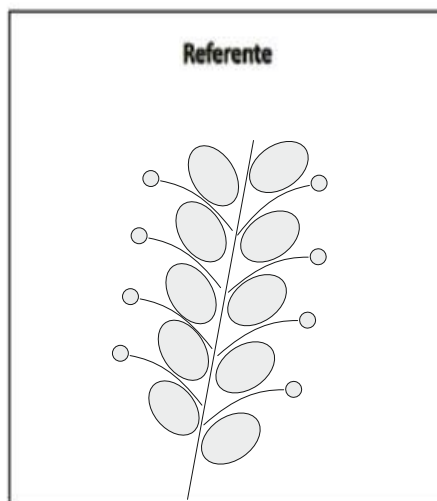

32 cm

Muestra 5 * 5 cm



38 cm

Ficha Técnica

Laboratorio

Accesorios personales

Línea

Bufanda

Producto

Pieza

Materias Primas

Lana Jasmin
matizada

Paleta de Color



\$30000

Costo

Fecha

Boceto 1 de 1

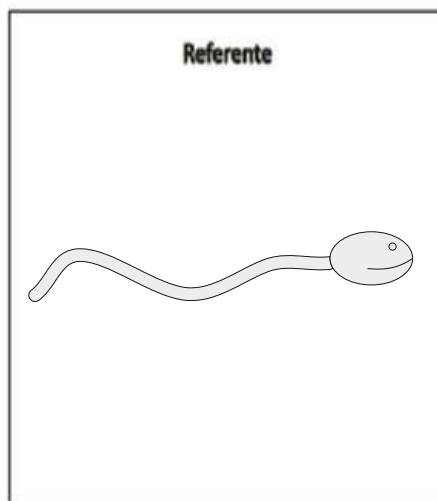

180 cm de largo por 20 cm de ancho

Ficha Técnica

Laboratorio

Accesorios personales

Línea

Chal

Producto

Pieza

Materias Primas

Lana Jazmín
matizada

Paleta de Color



\$80000

Costo

Fecha

Boceto 1 de 1

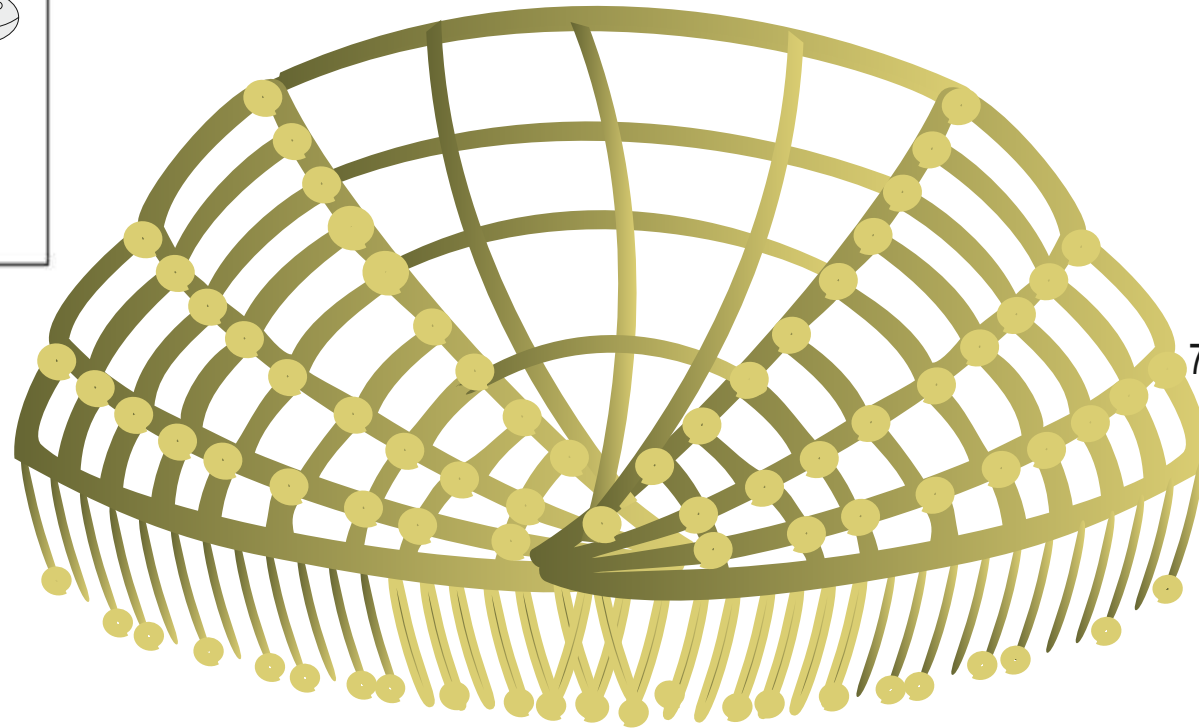
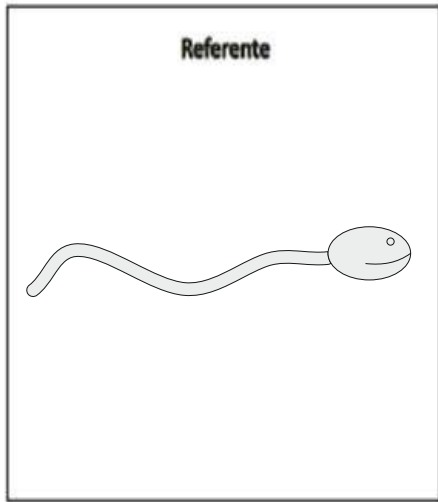

70 cm

140 cm

Ficha Técnica

Laboratorio

Accesorios personales

Línea

Cuello

Producto

Pieza

Materias Primas

Lana Jazmín

Paleta de Color



\$25000

Costo

Fecha

Boceto 1 de 1

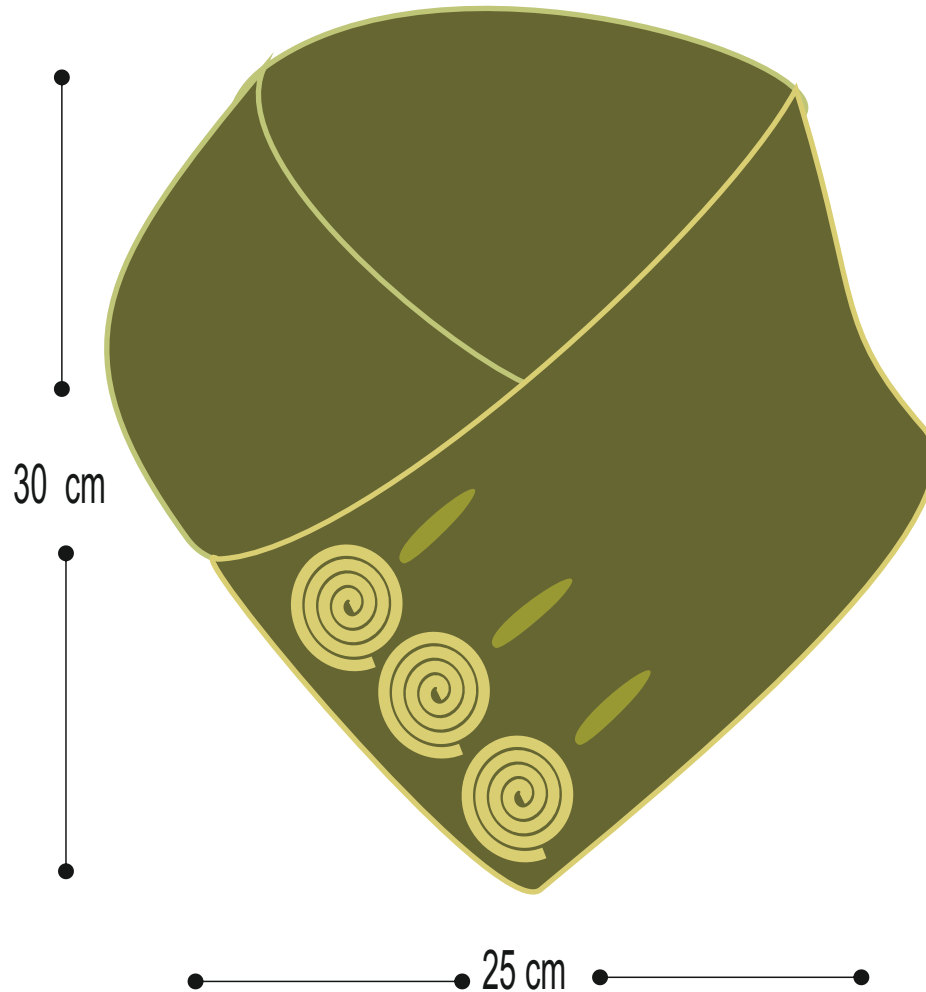
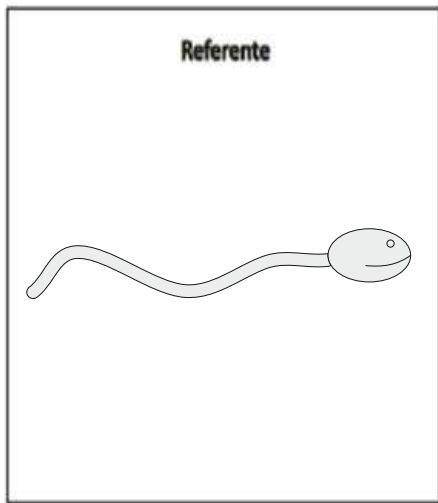

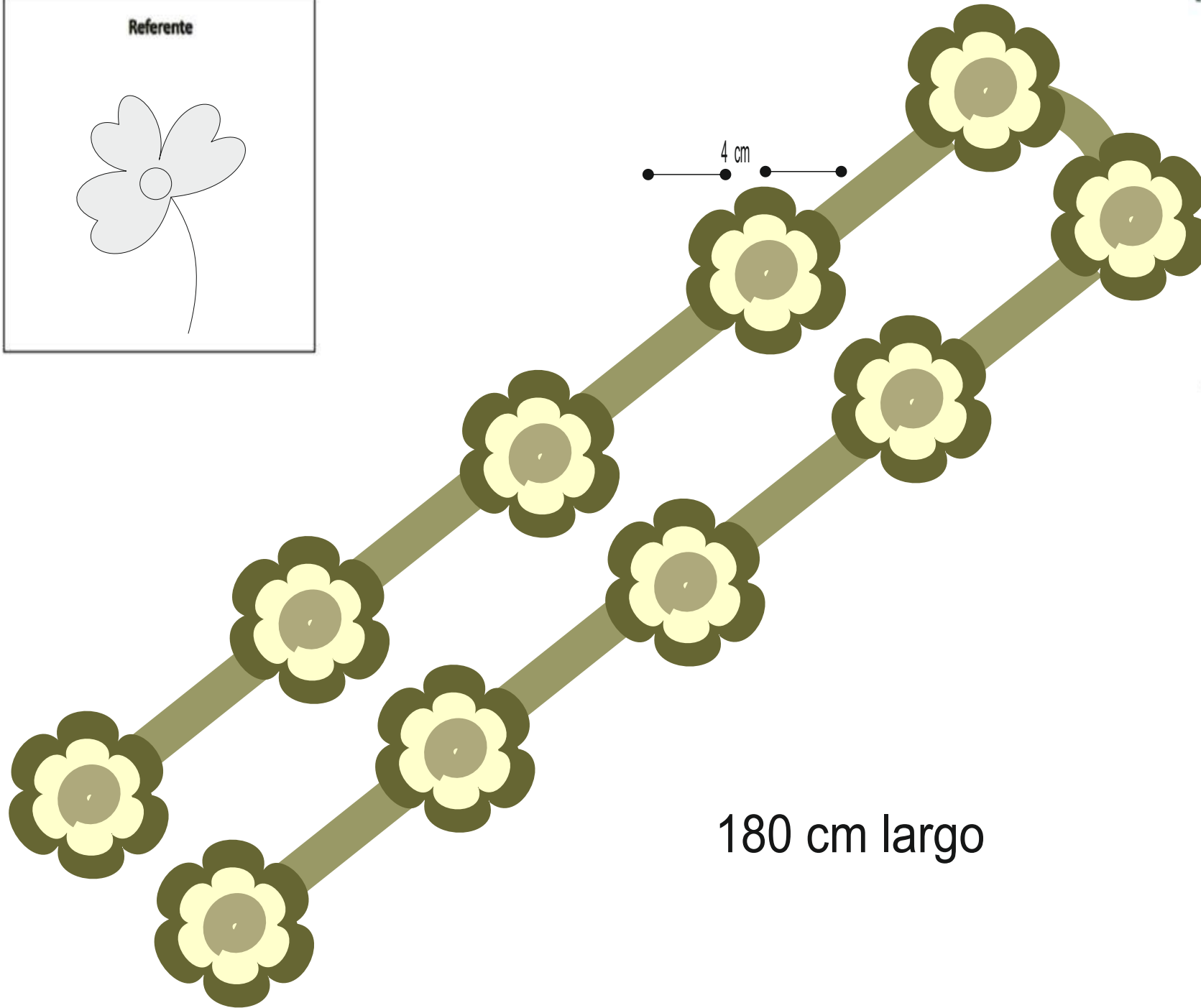
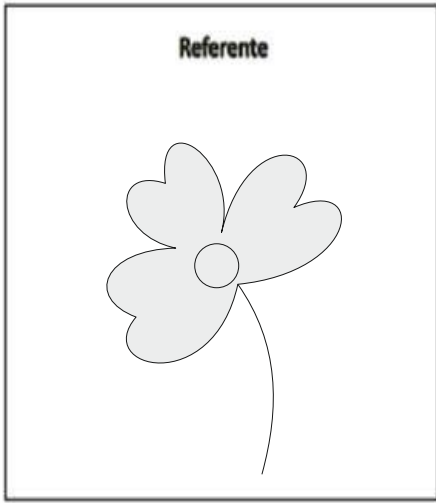

Ficha Técnica

Laboratorio

Accesorios personales

Línea

accesorio Mujer

Producto

Pieza

Materias Primas

Hilo perla

Paleta de Color

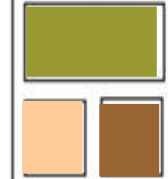

\$25000

Costo

Fecha

Boceto 1 de 1

Ficha Técnica

Laboratorio

Accesorios personales

Línea

Bufanda

Producto

Pieza

Materias Primas

Lana Jasmin
hilo perla

Paleta de Color



\$20000

Costo

Fecha

Boceto 1 de 1

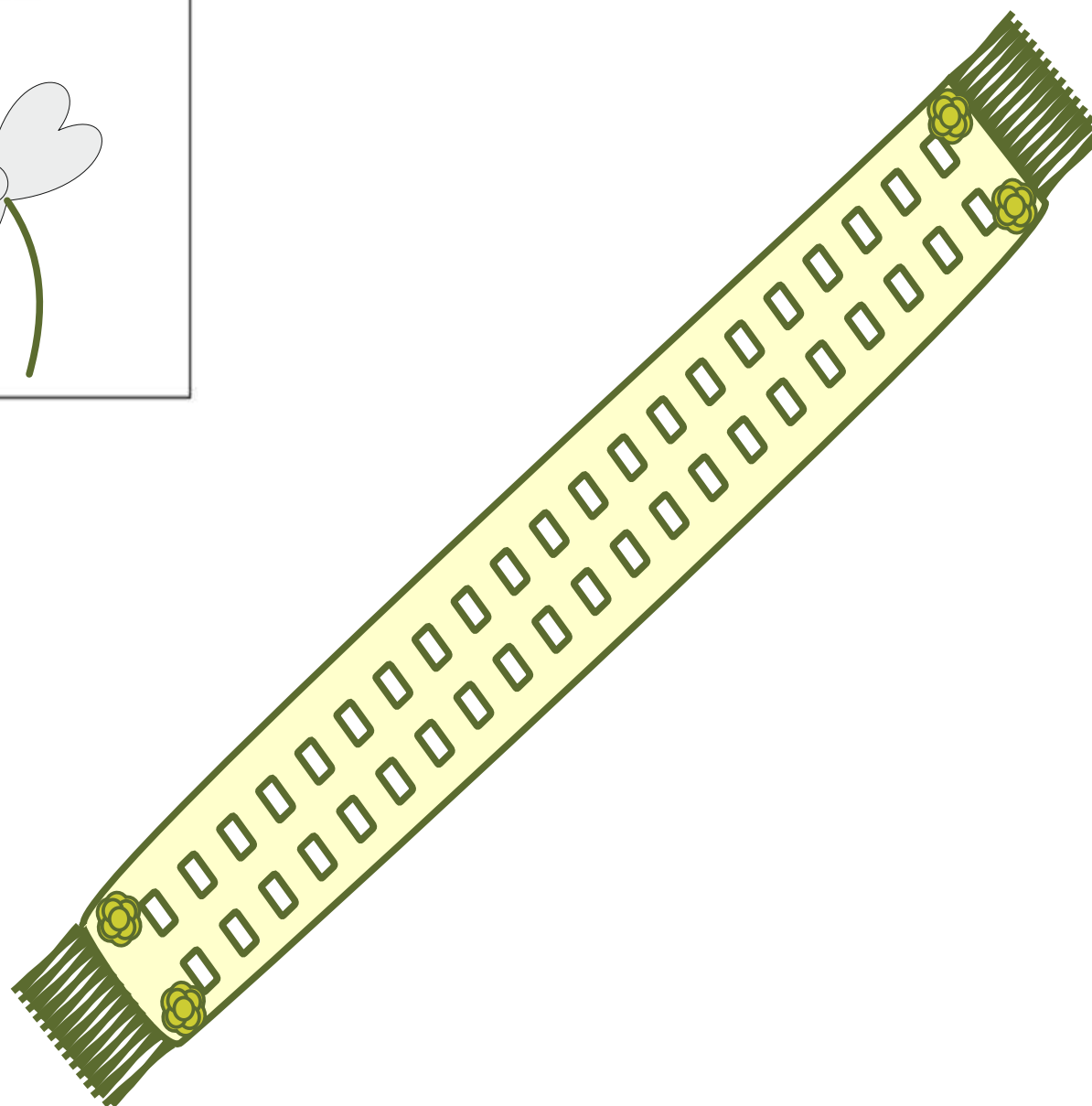
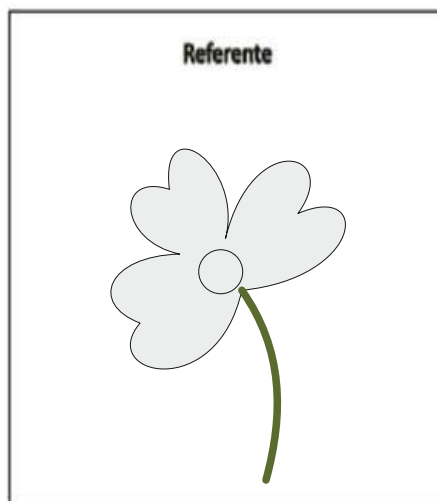

150 cm de largo por 15 cm de ancho

**M.SAN PEDRO
DE CARTAGO**

Ficha Técnica

Laboratorio

Bolsos

Línea

Bolso redondo

Producto

Pieza

Materias Primas
 Hilo guajiro, tela forro, fique

Paleta de Color

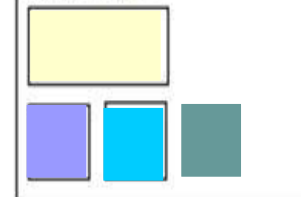

\$40000

Costo

Fecha

Boceto 1 de 1

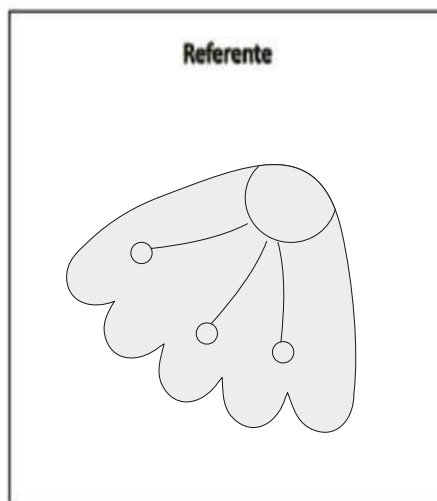

Tejido hilo guajiro

28 cm

14 cm

Tejido fique

28 cm

Base 20 cm



Ficha Técnica

Laboratorio

Bolsos

Línea

Bolso Cuadrado

Producto

Pieza

Materias Primas

Hilo guajiro, tela forro, fique

Paleta de Color

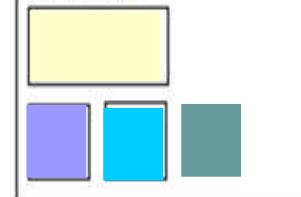

\$40000

Costo

Fecha

Boceto 1 de 1

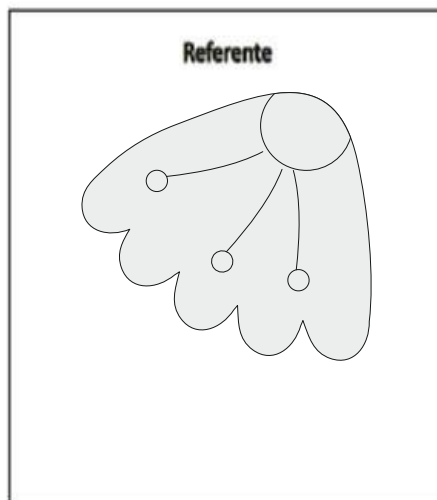

Tejido hilo guajiro

30 cm

14 cm

Tejido fique

30 cm



Ficha Técnica

Laboratorio

Bolsos

Línea

Mochila

Producto

Pieza

Materias Primas
 Hilo guajiro, tela forro, fique

Paleta de Color

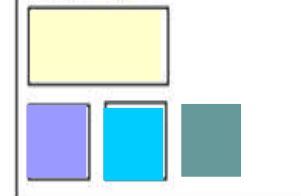

\$45000

Costo

Fecha

Boceto 1 de 1

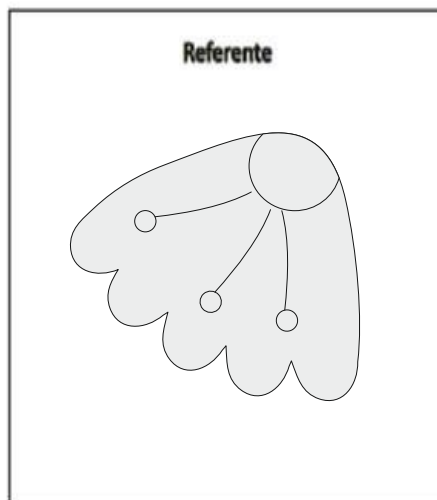

Tejido hilo guajiro

28cm

Tejido fique

14 cm

Base 20 cm

28 cm



Ficha Técnica

Laboratorio

Accesorios personales

Línea

Bufanda

Producto

Pieza

Materias Primas

Lana jazmín
matizada

Paleta de Color

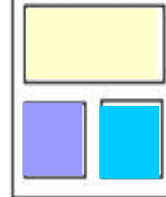

\$25000

Costo

Fecha

Boceto 1 de 1

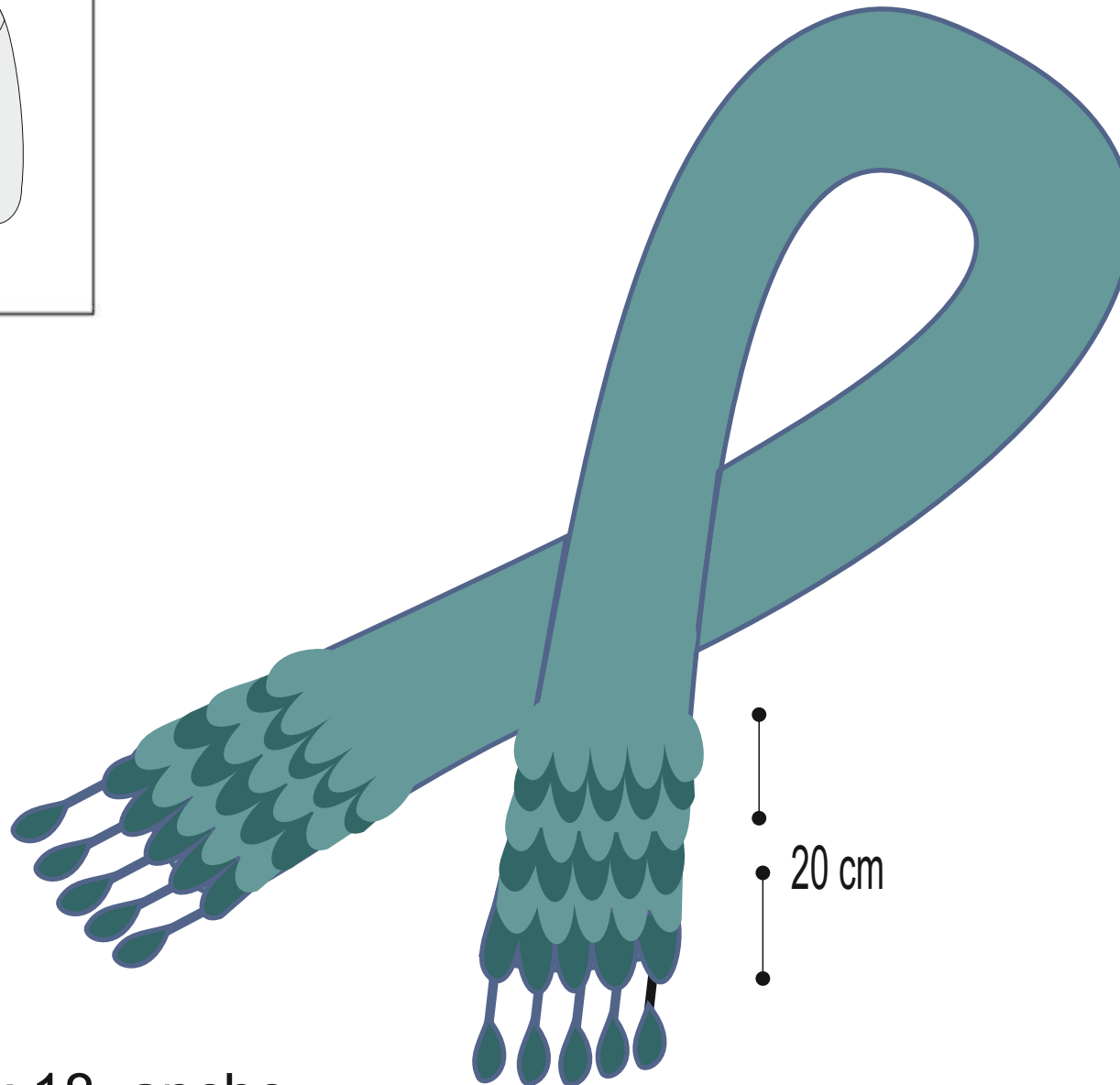
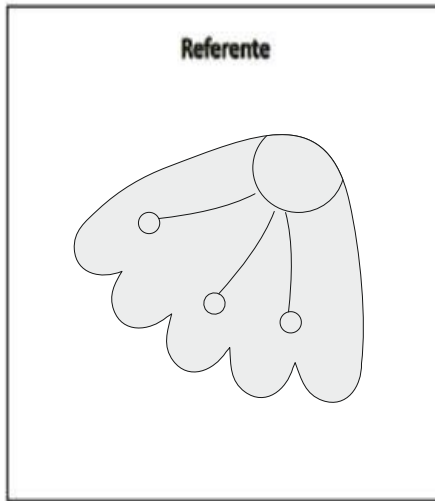

170 largo x 18 ancho

Laboratorio

Mesa

Línea

Individual

Producto

Pieza

Materias Primas

Lana jazmin
fique

Paleta de Color



\$ 15000 Unidad

Costo

Fecha

Boceto 1 de 1

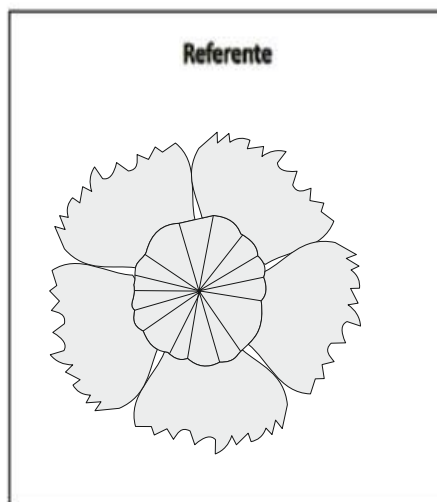

33 cm D.

33 cm D.

Tejido lana
Jazmin

Tejido Fique

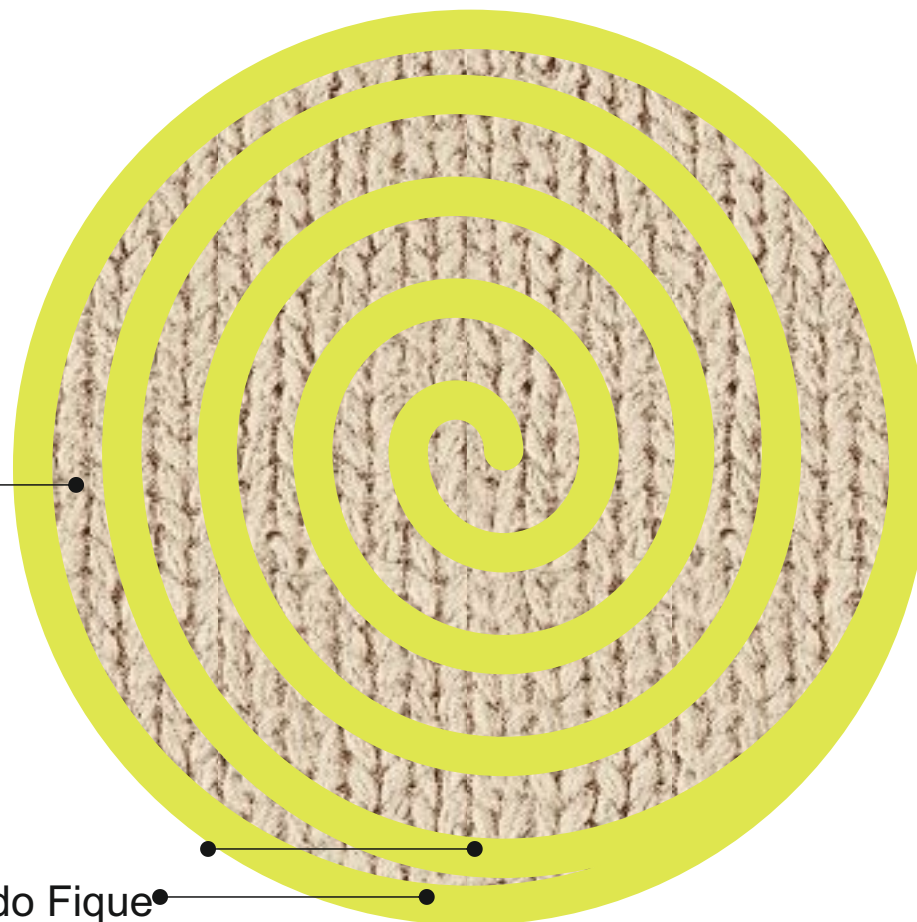

Ficha Técnica

Laboratorio

home decor

Línea

Portavasos

Producto

Pieza

Materias Primas

Lana jazmín
fique

Paleta de Color



\$30000

Costo

Fecha

Boceto 1 de 1

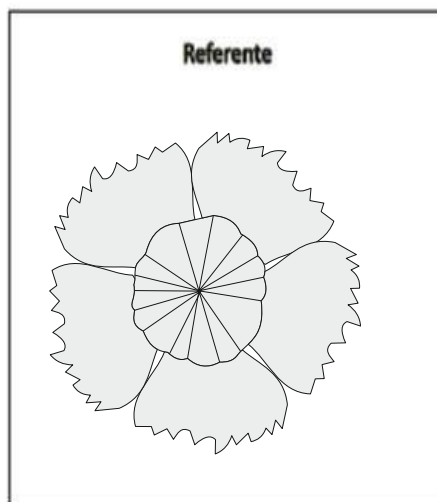

Tejido lana
Jazmin

Tejido Fique

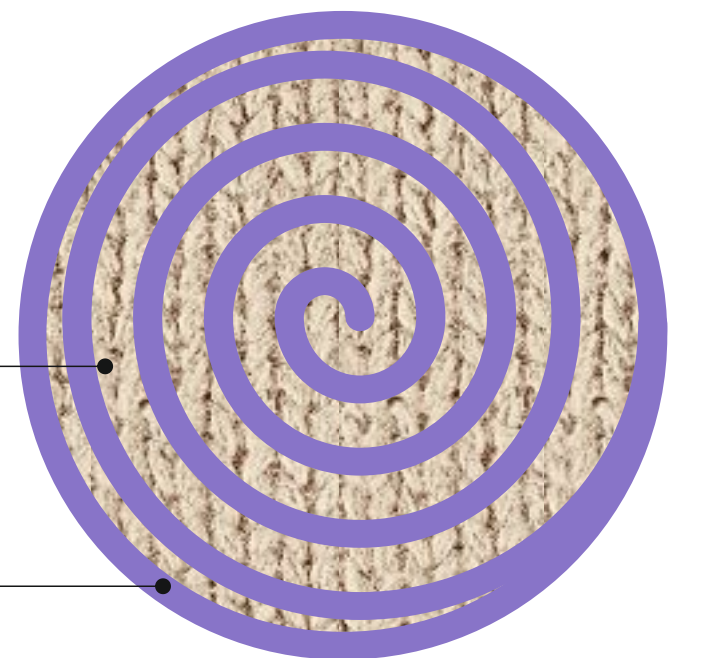

10 cm D

Ficha Técnica

Laboratorio

Mesa

Línea

Juego individuales

Producto

Pieza

Materias Primas

Lana jazmín
fique

Paleta de Color



\$30000

Costo

Fecha

Boceto 1 de 1

Referente

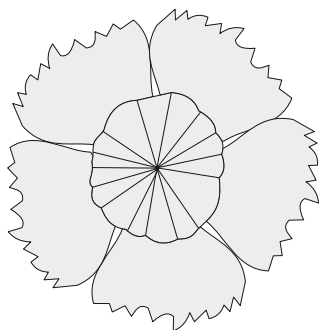

Ficha Técnica

Laboratorio

home decor

Línea

Porta caliente

Producto

Pieza

Materias Primas

Lana jasmin
fique

Paleta de Color



\$30000

Costo

Fecha

Boceto 1 de 1

Referente

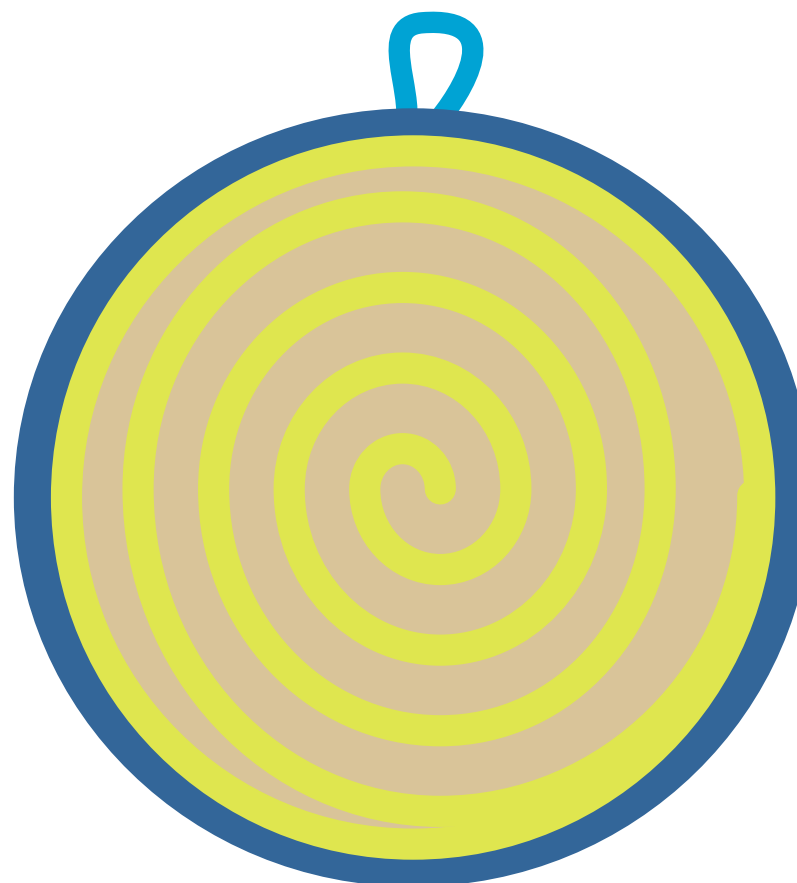
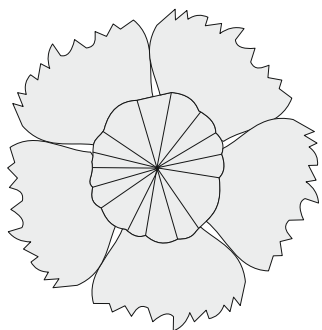

25 cm D

Ficha Técnica

Laboratorio

Contenedor

Línea

Caja organizadora

Producto

Pieza

Materias Primas

Papel, cobon
mdf, vinilo,
patina

Paleta de Color

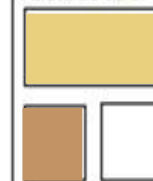

\$25000

Costo

Fecha

Boceto 1 de 1

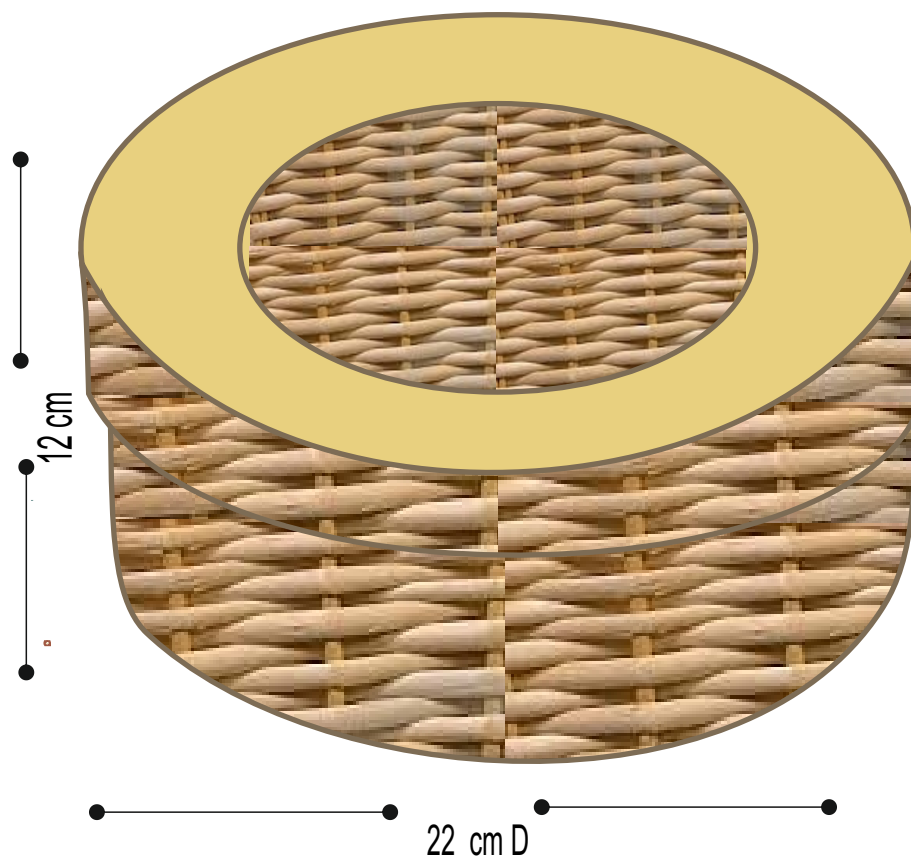
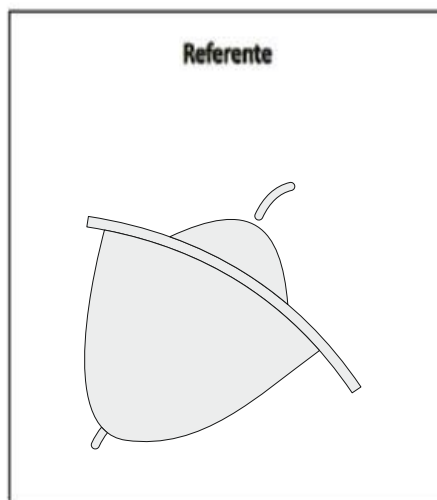

Tejido en papel

Ficha Técnica

Laboratorio

Contenedor

Línea

Contenedor 1

Producto

Pieza

Materias Primas

Papel, colchon
mdf, pintura

Paleta de Color

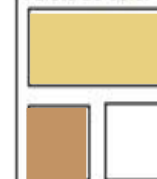

\$20000

Costo

Fecha

Boceto 1 de 1

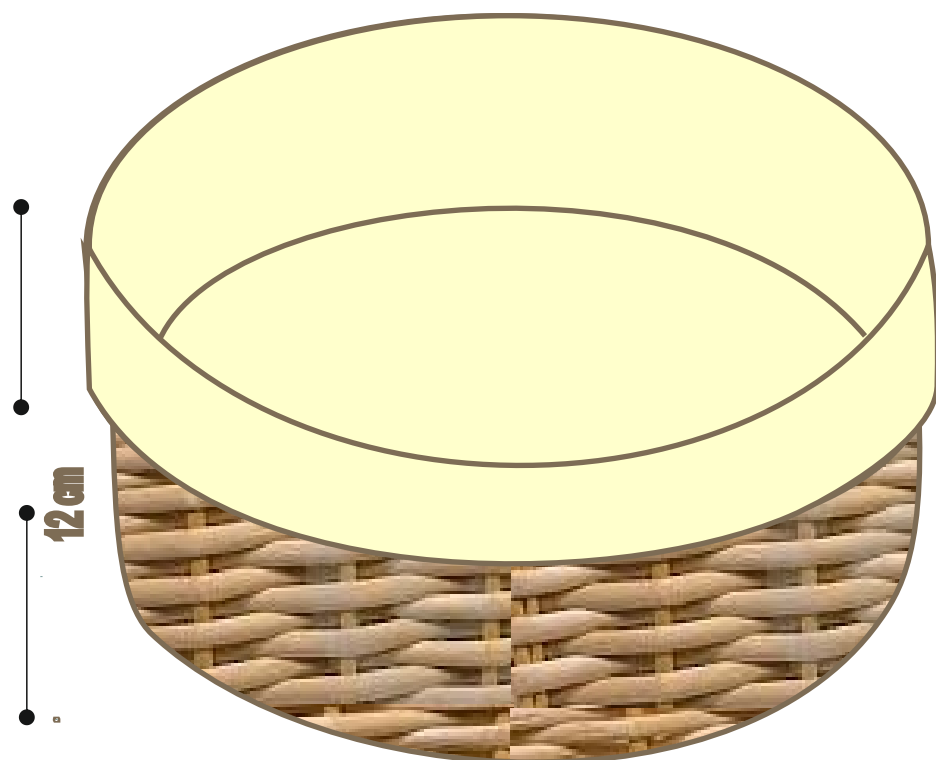
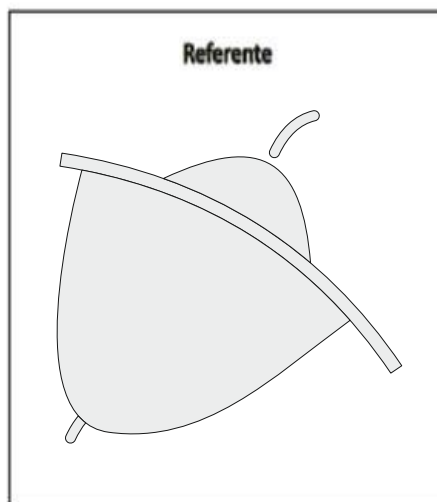

12 cm

22 cm D

Tejido en papel

Ficha Técnica

Laboratorio

Home decor

Línea

Muñeca

Producto

Pieza

Materias Primas

Fique, lana
perla

Paleta de Color



Costo

Fecha

Boceto 1 de 1

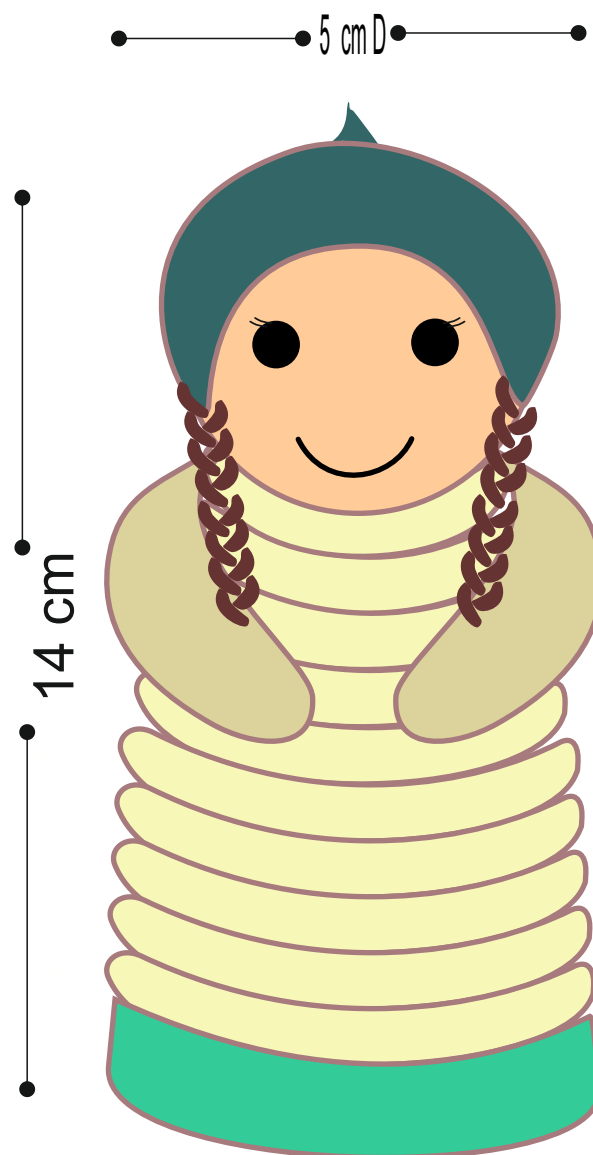
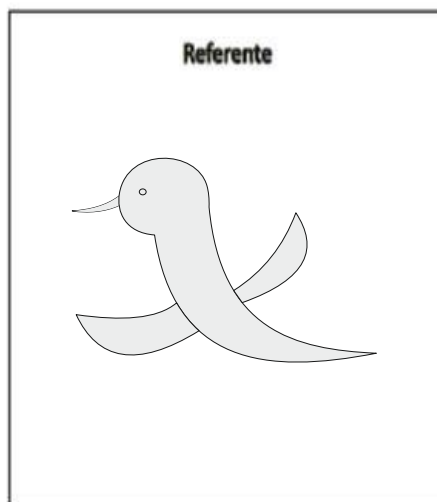

Ficha Técnica

Laboratorio

Bolsos

Línea

Bolso redondo

Producto

Pieza

Materias Primas

Hilo guajiro, tela forro, fique

Paleta de Color



\$40000

Costo

Fecha

Boceto 1 de 1

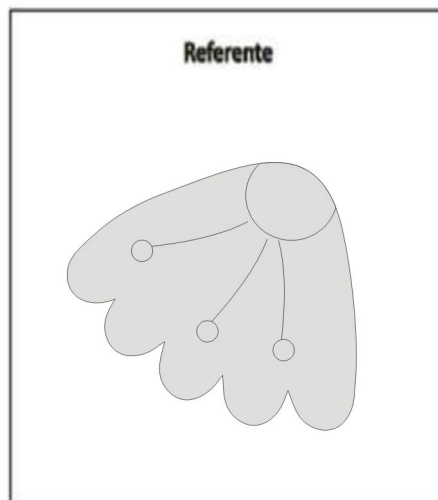

Tejido hilo guajiro

28 cm

14 cm

Tejido fique

28 cm

Base 20 cm

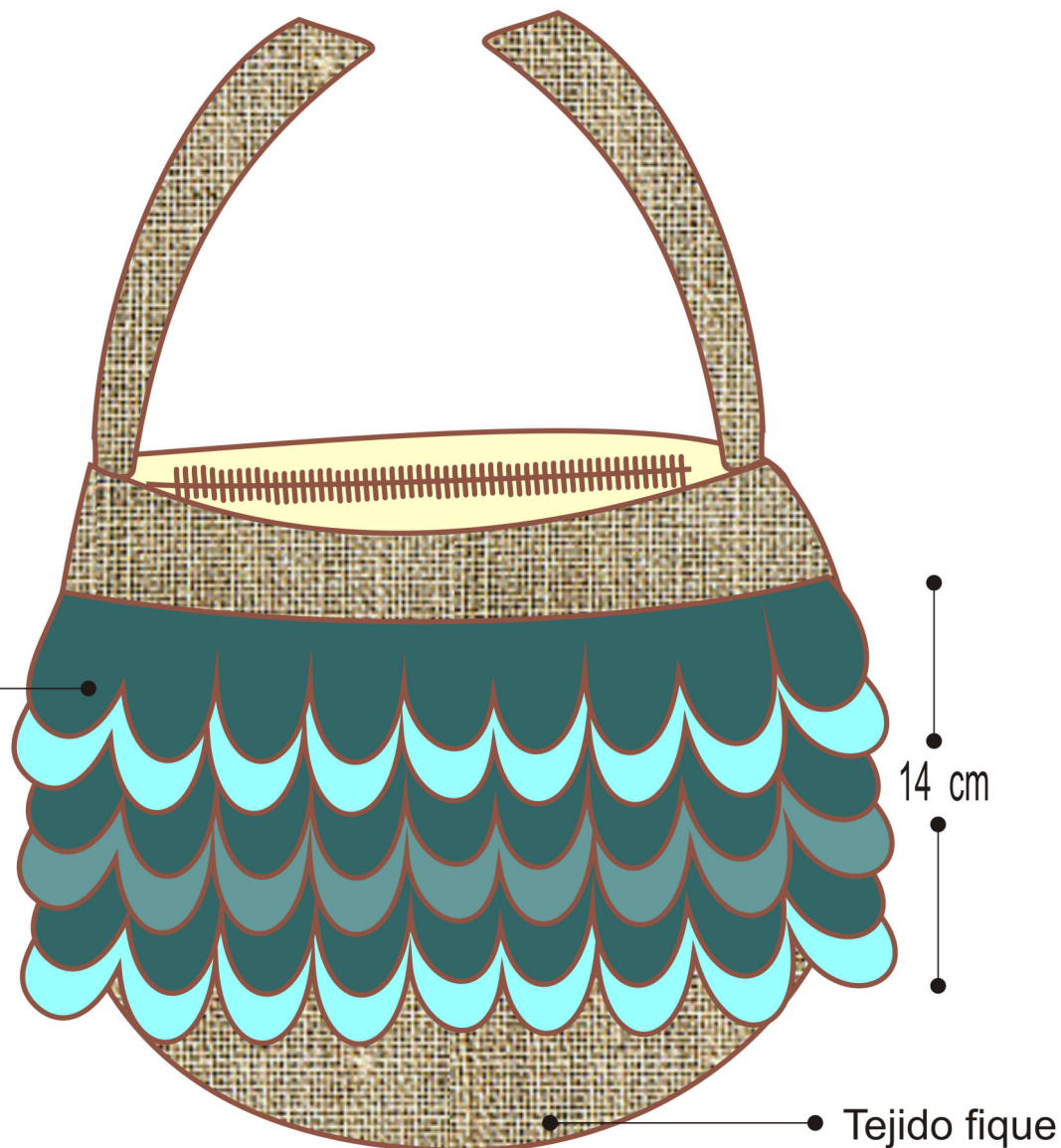

Ficha Técnica

Laboratorio

Bolsos

Línea

Bolso Cuadrado

Producto

Pieza

Materias Primas

Hilo guajiro, tela forro, fique

Paleta de Color



\$40000

Costo

Fecha

Boceto 1 de 1

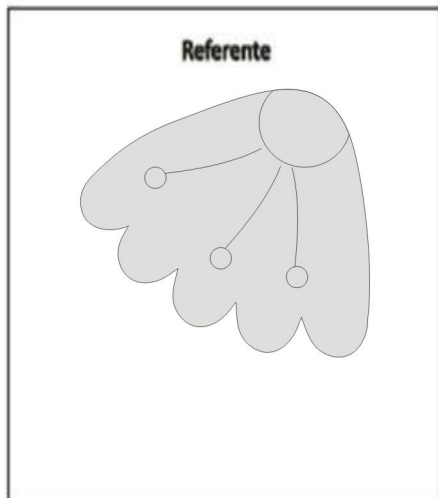

Tejido hilo guajiro

30 cm

14 cm

Tejido fique

30 cm



Ficha Técnica

Laboratorio

Bolsos

Línea

Mochila

Producto

Pieza

Materias Primas

Hilo guajiro, tela forro, fique

Paleta de Color



\$45000

Costo

Fecha

Boceto 1 de 1

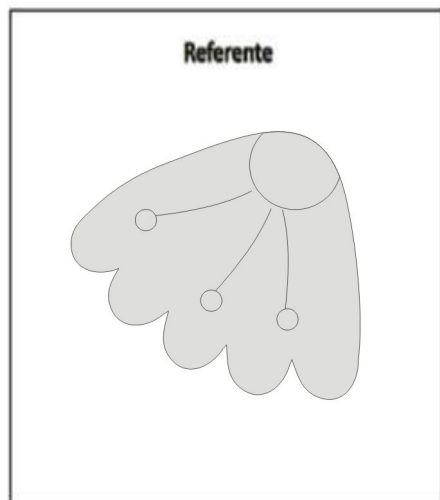

Tejido hilo guajiro

28cm

14 cm

Base 20 cm

28 cm

Tejido fique



Ficha Técnica

Laboratorio

Accesorios personales

Línea

Bufanda

Producto

Pieza

Materias Primas
Lana jazmín
matizada

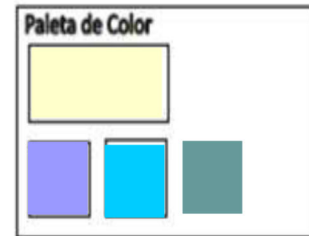

\$25000

Costo

Fecha

Boceto 1 de 1

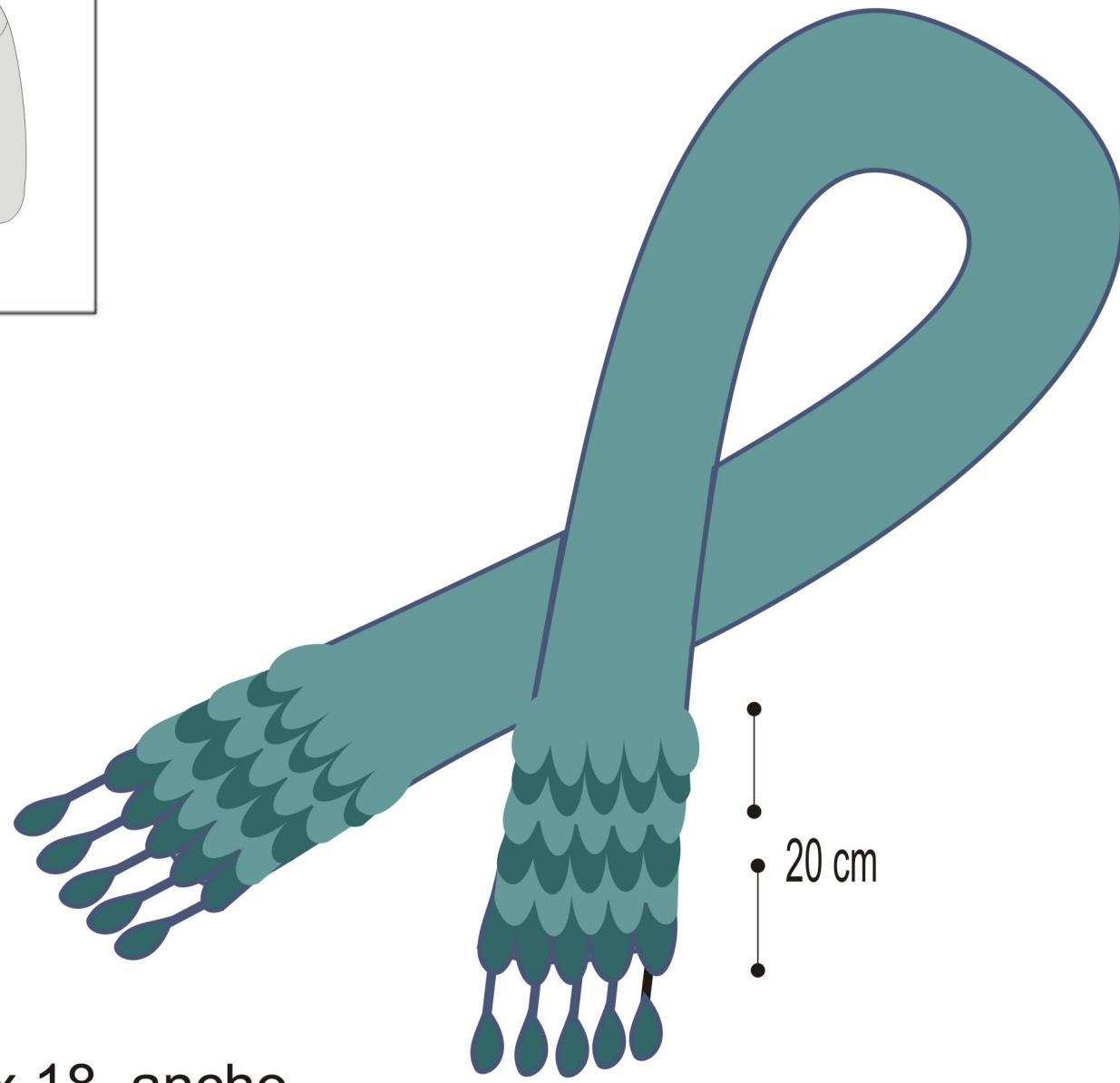
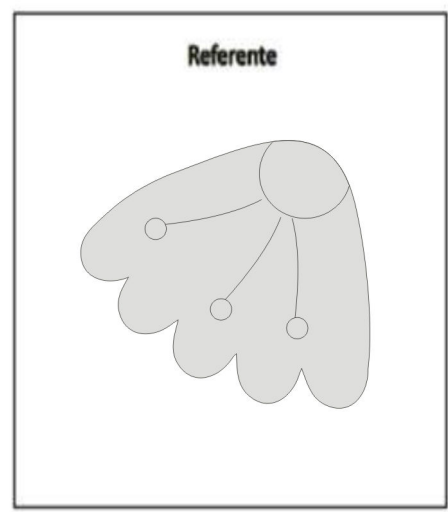

170 largo x 18 ancho

Ficha Técnica

Laboratorio

Contenedor

Línea

Caja organizadora

Producto

Pieza

Materias Primas

Papel, cobon
mdf, vinilo,
patina

Paleta de Color



\$25000

Costo

Fecha

Boceto 1 de 1

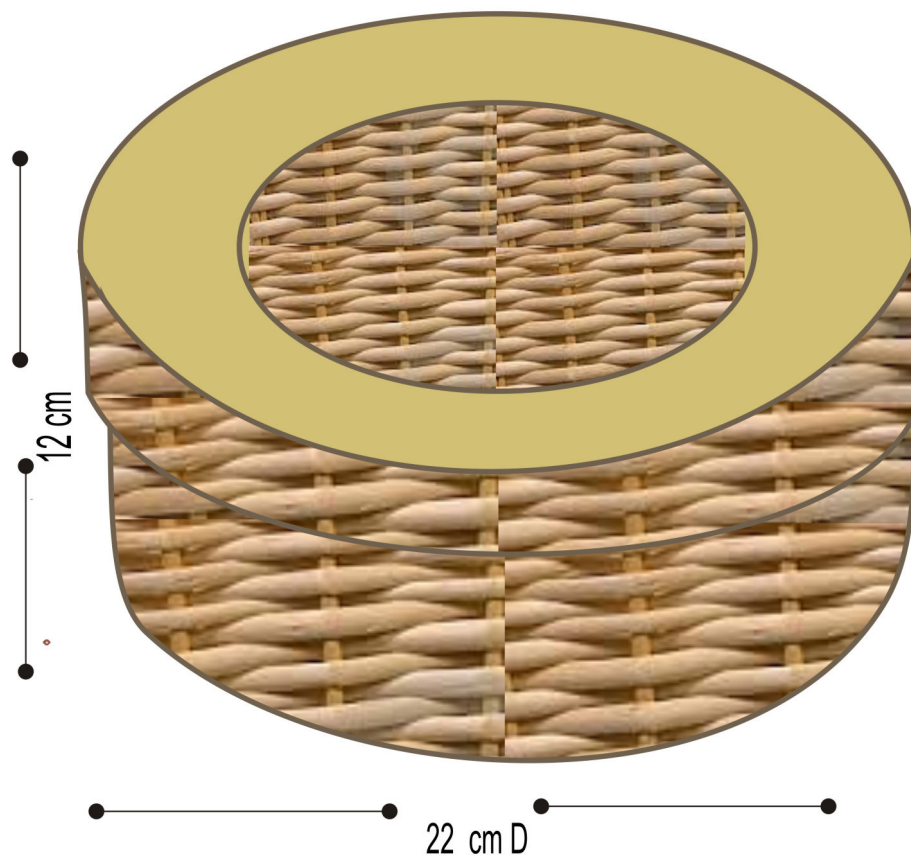
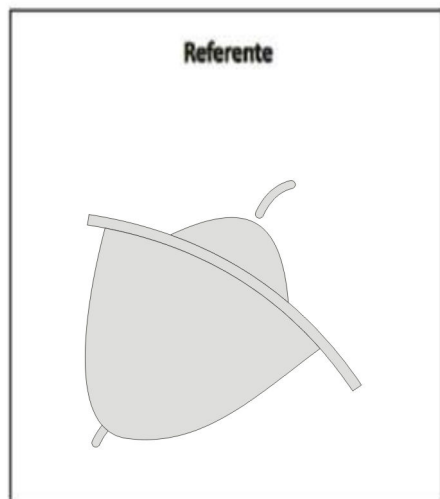

Tejido en papel

Ficha Técnica

Laboratorio

Contenedor

Línea

Contenedor 1

Producto

Pieza

Materias Primas

Papel, colbon
mdf, pintura

Paleta de Color



\$20000

Costo

Fecha

Boceto 1 de 1

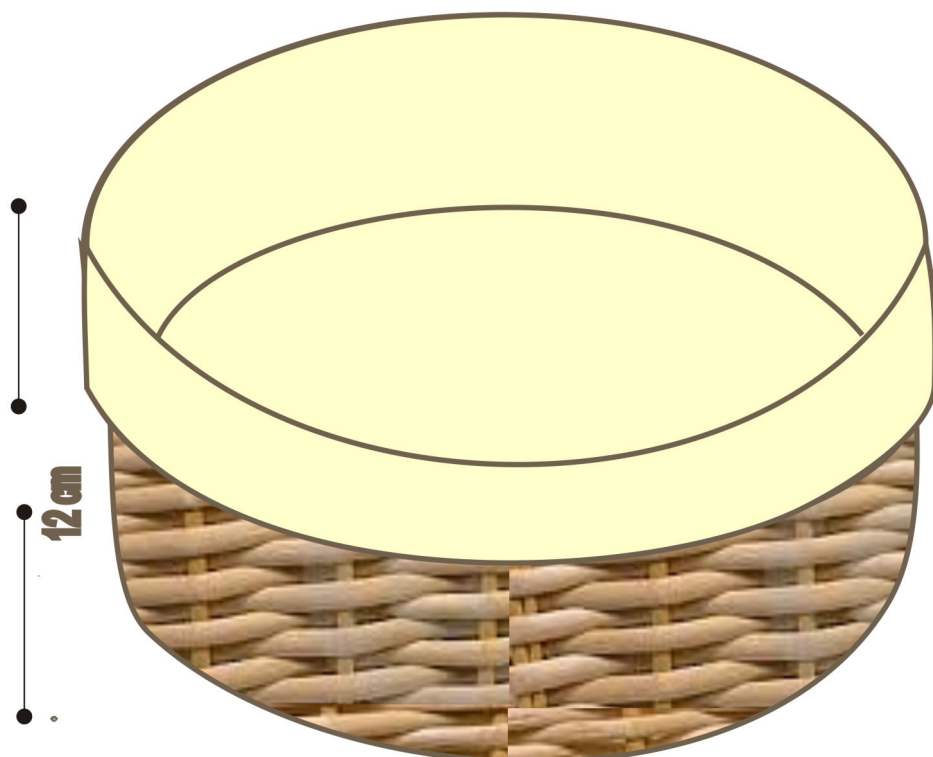
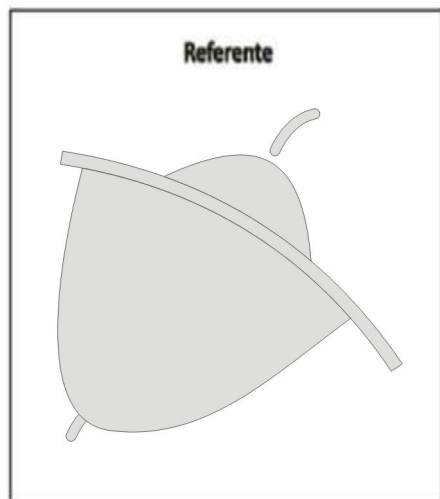

12 cm

22 cm D

Tejido en papel

Laboratorio

Mesa

Línea

Individual

Producto

Pieza

Materias Primas

Lana jasmin
 fique

Paleta de Color



\$ 15000 Unidad

Costo

Fecha

Boceto 1 de 1

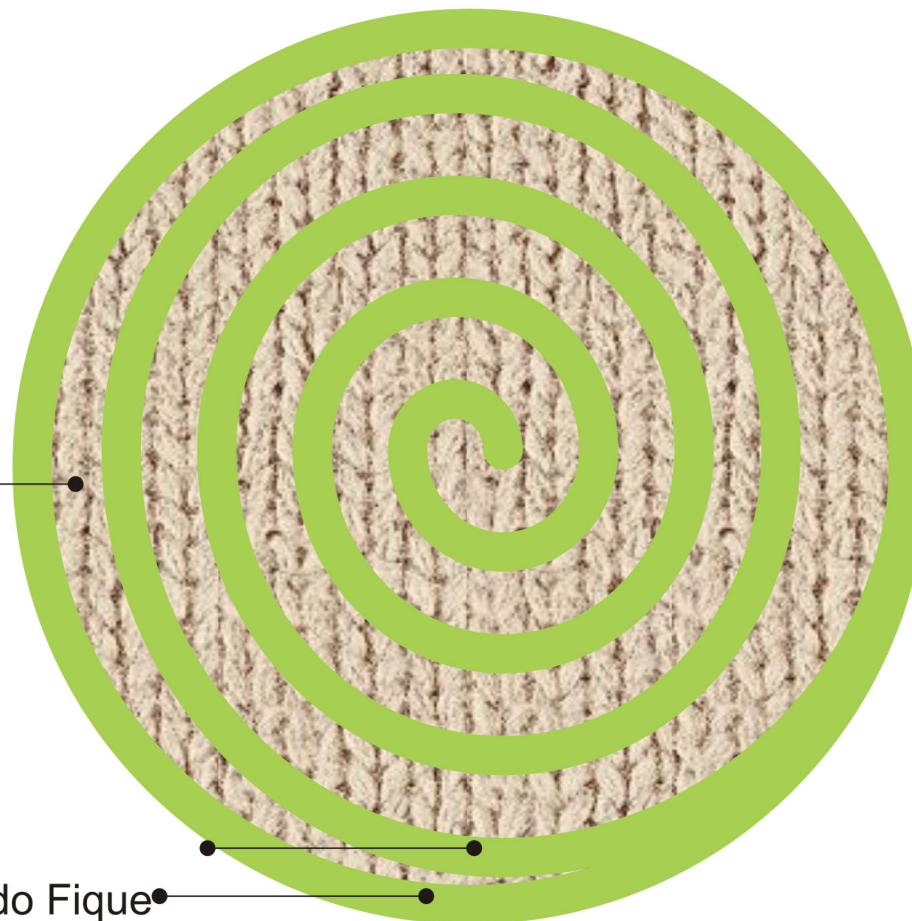
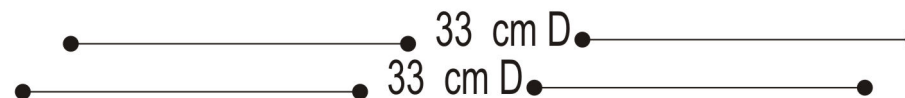
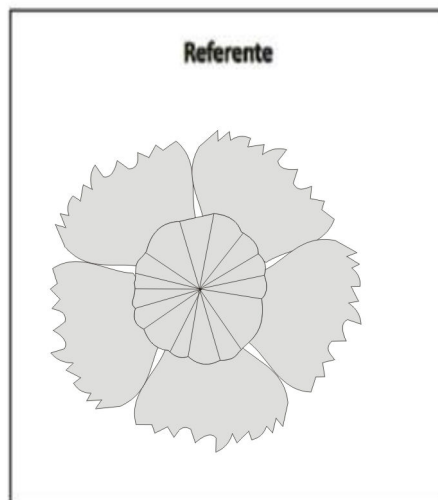

Tejido lana
 Jazmin

Tejido Fique

Ficha Técnica

Laboratorio

Mesa

Línea

Juego individuales

Producto

Pieza

Materias Primas

Lana jazmín
fique

Paleta de Color



\$ 40000

Costo

Fecha

Boceto 1 de 1

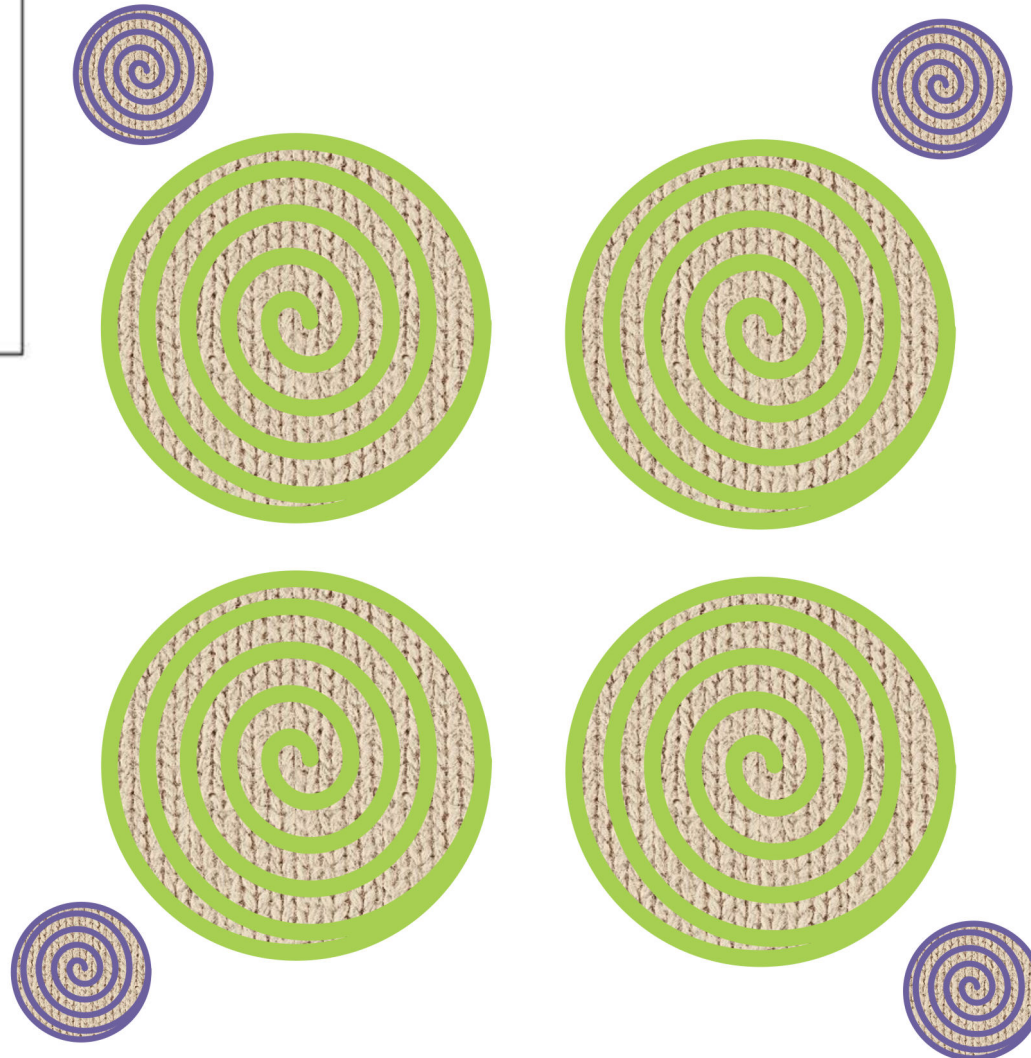
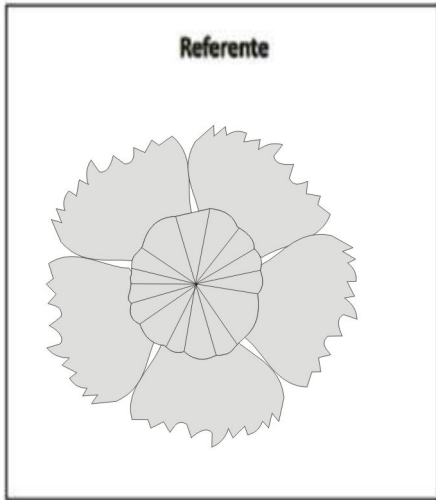

Ficha Técnica

Laboratorio

Home decor

Línea

Muñeca

Producto

Pieza

Materias Primas

Fique, lana
perla

Paleta de Color



Costo

Fecha

Boceto 1 de 1

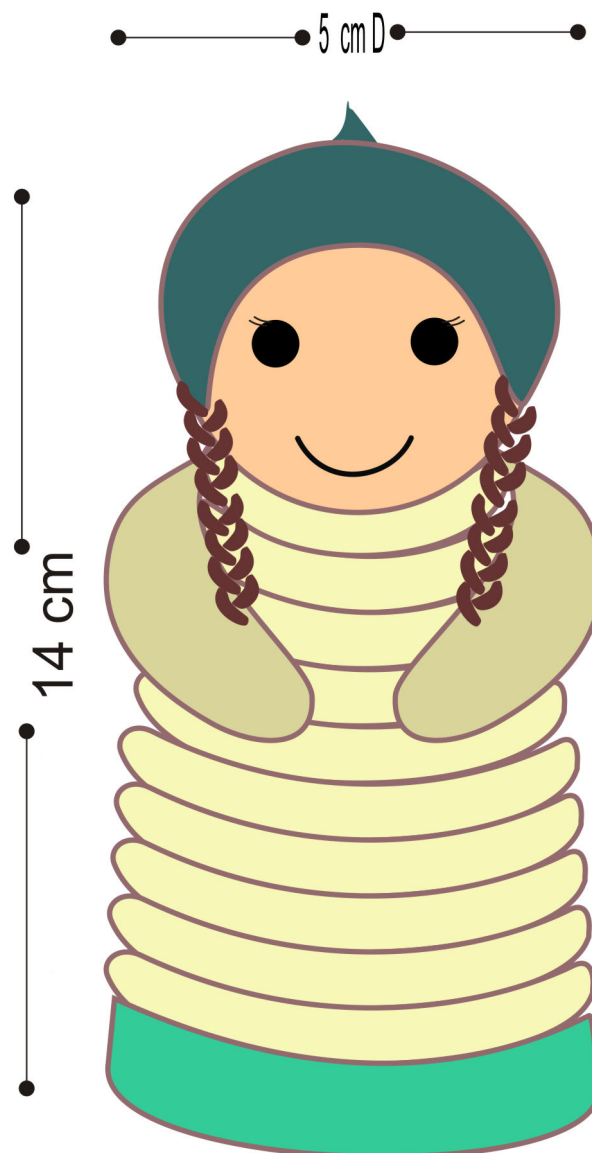
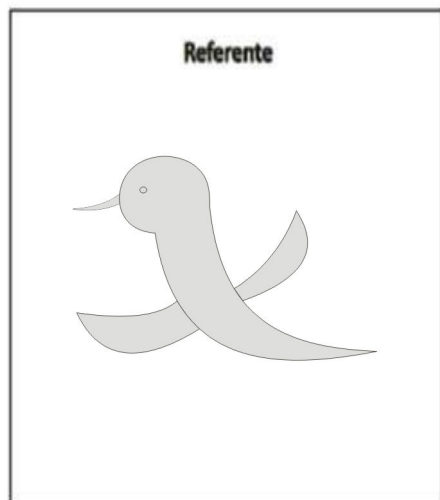

Ficha Técnica

Laboratorio

Mesa

Línea

Porta caliente

Producto

Pieza

Materias Primas

Lana jasmin
fique

Paleta de Color



\$15000

Costo

Fecha

Boceto 1 de 1

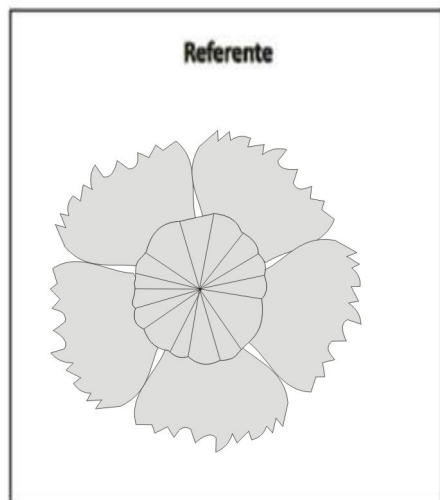

Tejido lana
Jazmin

Tejido Fique

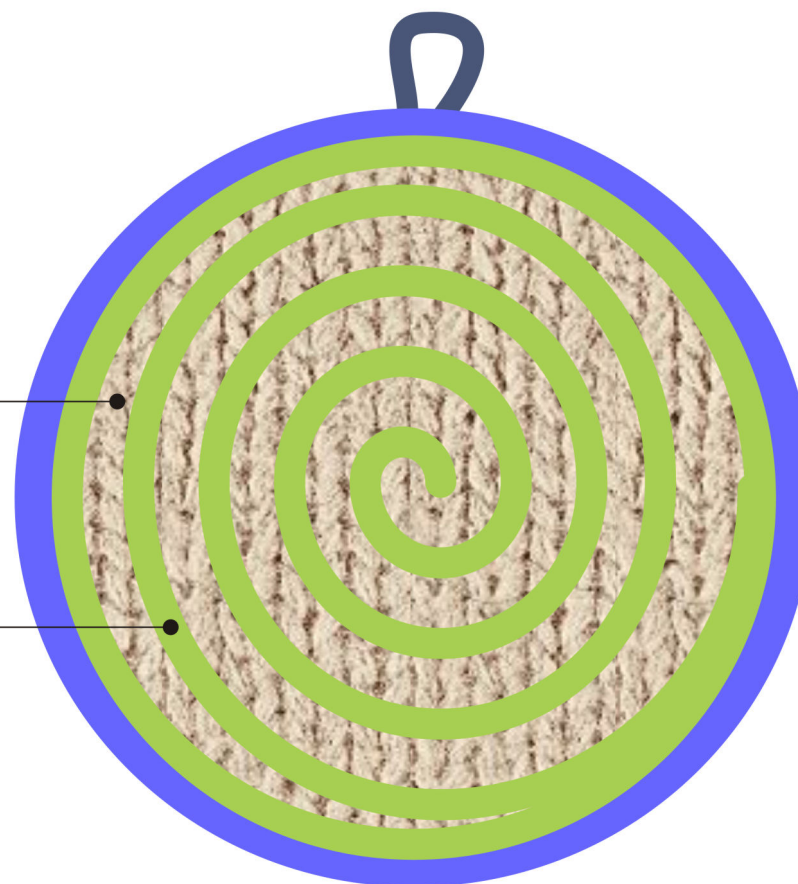

25 cm D

Ficha Técnica

Laboratorio

home decor

Línea

Portavasos

Producto

Pieza

Materias Primas

Lana jazmín
fique

Paleta de Color



\$30000

Costo

Fecha

Boceto 1 de 1

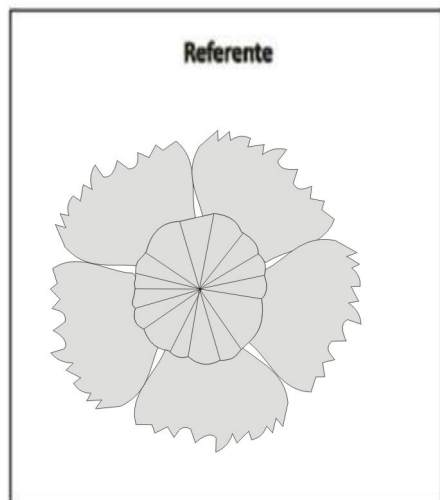

Tejido lana
Jazmin

Tejido Fique

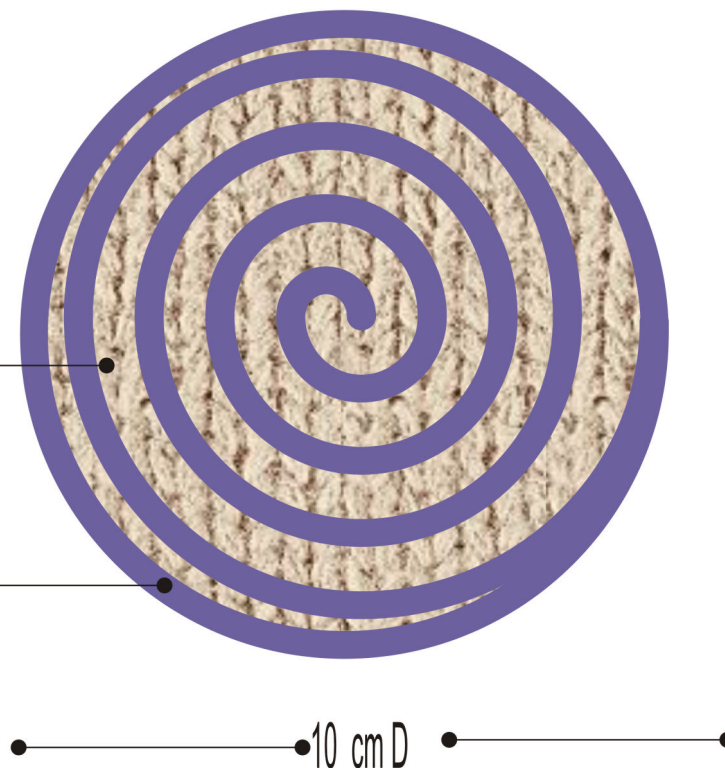

10 cm D

Ficha Técnica

Laboratorio

Mesa

Línea

Bandeja

Producto

Pieza

Materias Primas

Paja toquilla, arcilla

Paleta de Color



\$ 35000

Costo

Fecha

Boceto 1 de 1

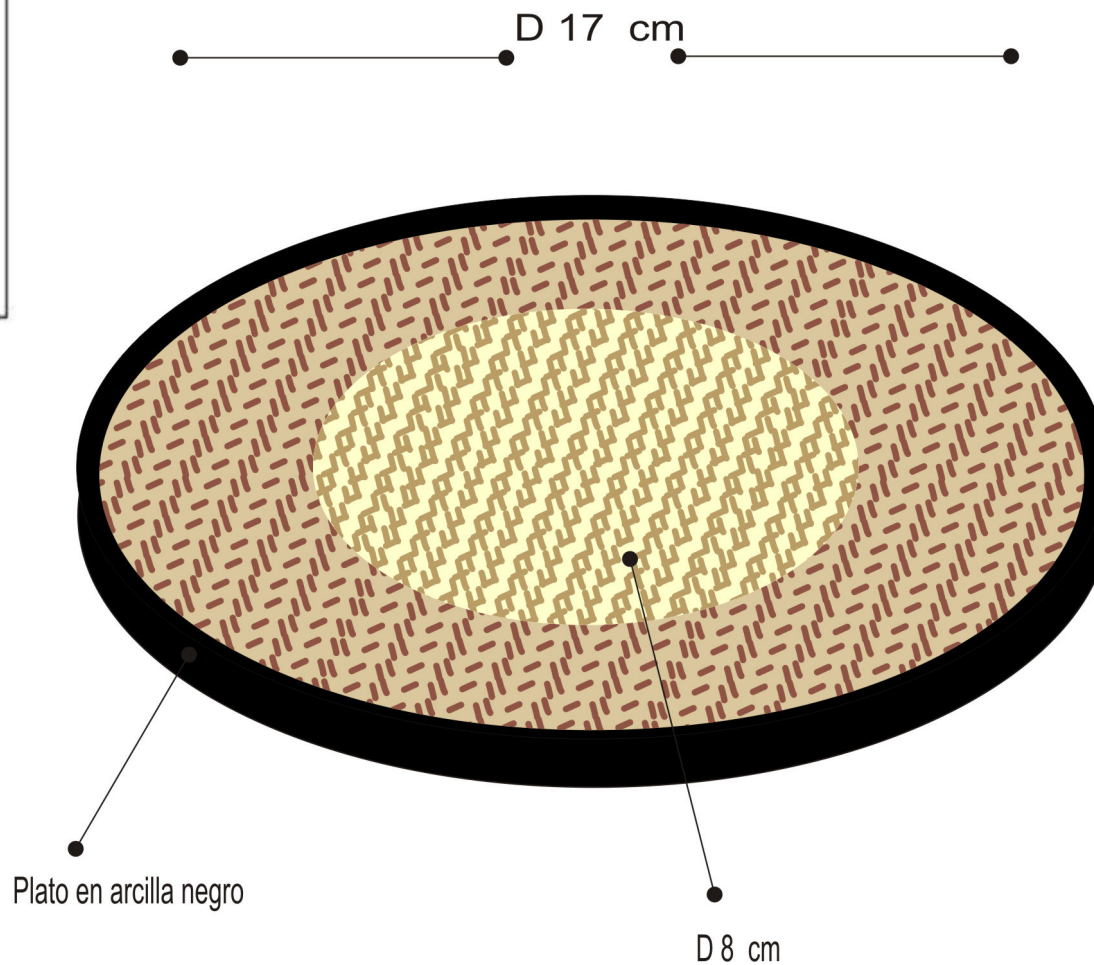
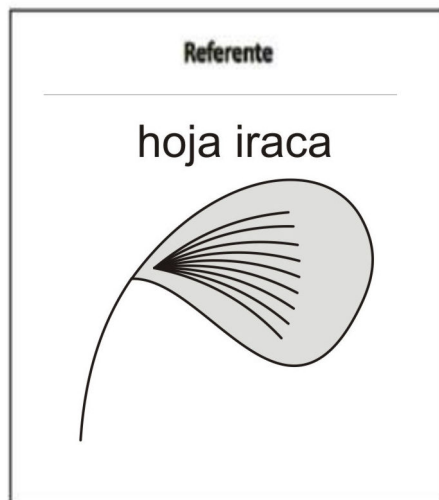

Tejido en paja gruesa en dos colores.

Laboratorio

Contenedores

Línea

Contenedor 1

Producto

Pieza

Materias Primas

Paja toquilla, Cuero

Paleta de Color



\$30000

Costo

Fecha

Boceto 1 de 1

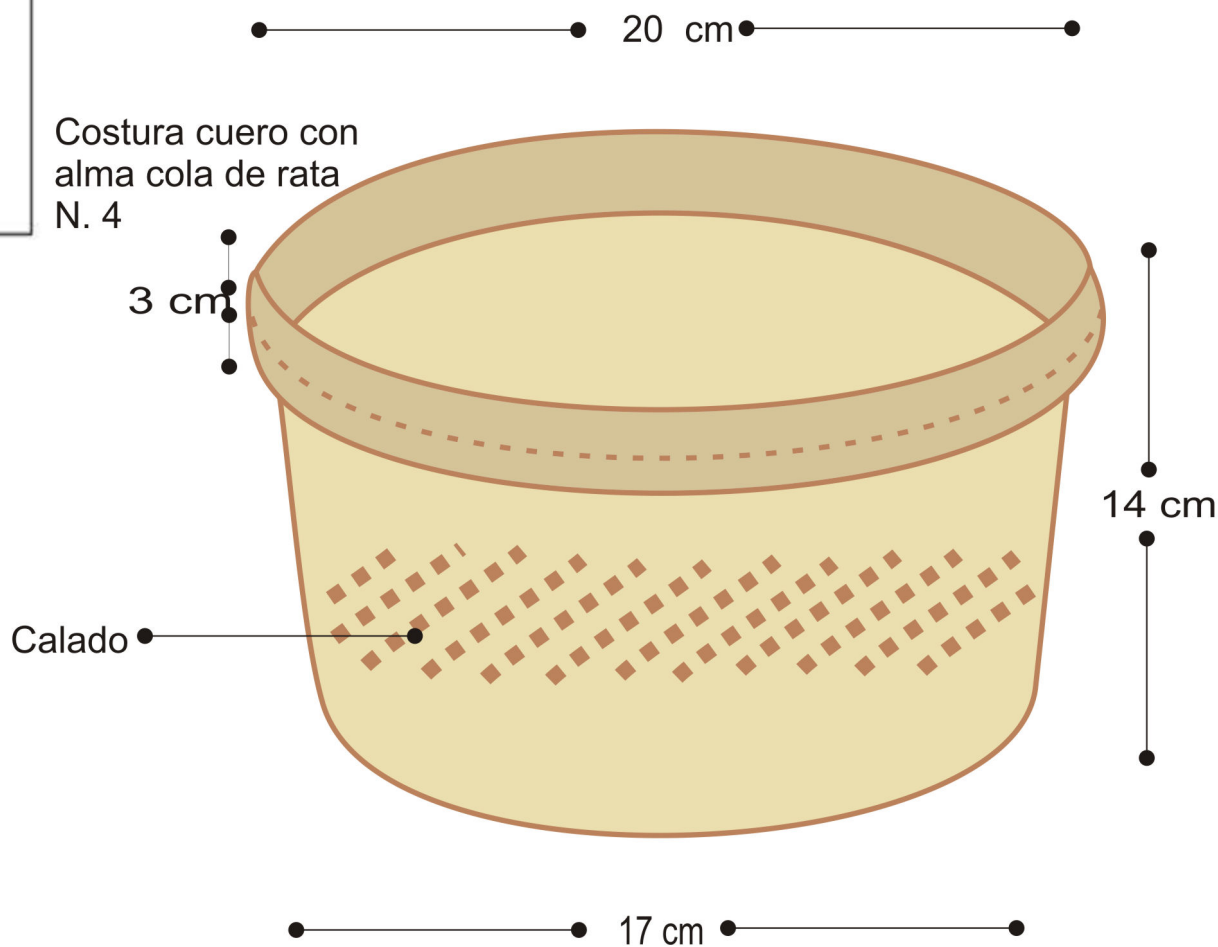
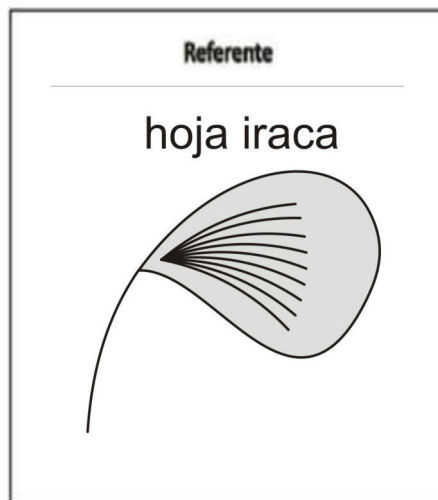

Tejido en paja gruesa, tipo de tejido granizo .

Ficha Técnica

Laboratorio

Contenedores

Línea

Contenedor 2

Producto

Pieza

Materias Primas

Paja toquilla,
Cuero

Paleta de Color



\$30000

Costo

Fecha

Boceto 1 de 1



Costura cuero con
alma cola de rata
N. 4

3 cm

20 cm

14 cm

Calado

17 cm

Tejido en paja gruesa, tipo de tejido granizo .

Ficha Técnica

Laboratorio

Contenedores

Línea

Contenedor 3

Producto

Pieza

Materias Primas

Paja toquilla, Cuero

Paleta de Color



\$30000

Costo

Fecha

Boceto 1 de 1

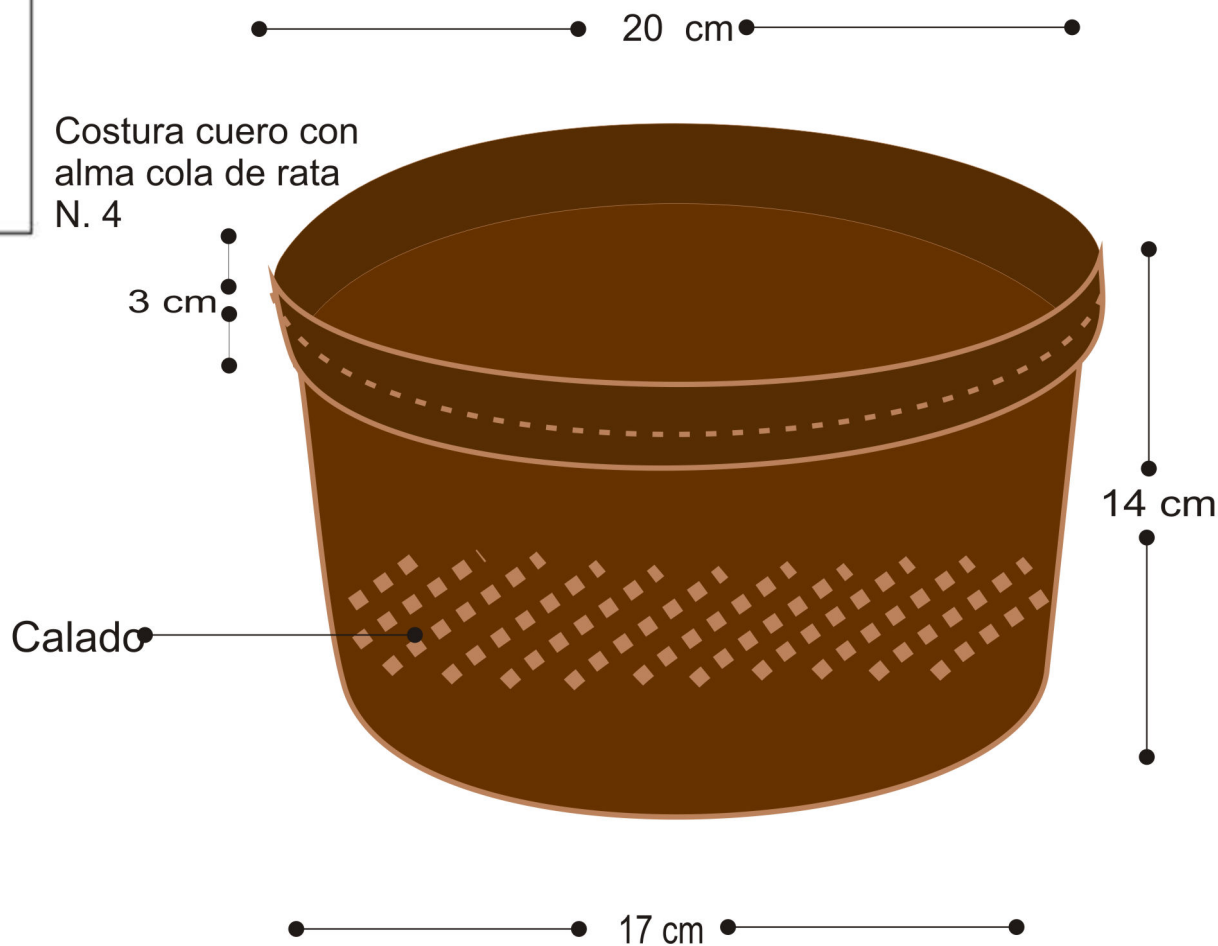

Costura cuero con
 alma cola de rata
 N. 4

Tejido en paja gruesa, tipo de tejido granizo .

Laboratorio

Mesa

Línea

Individual

Producto

Pieza

Materias Primas

Paja toquilla

Paleta de Color



\$ 15000 Unidad

Costo

Fecha

Boceto 1 de 1

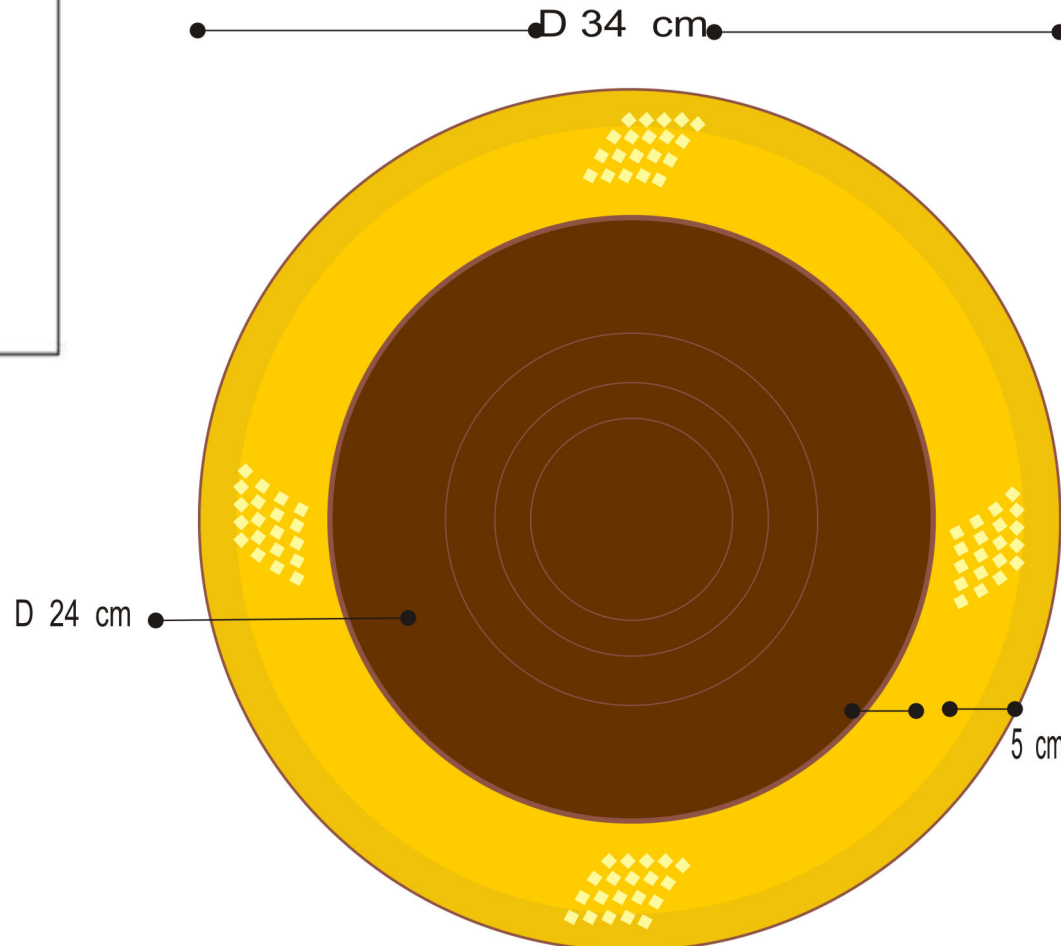
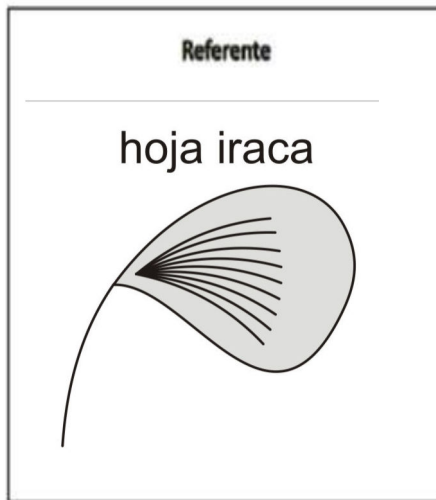

Tejido en paja gruesa con cambio de pajas de color cafe a amarillo, tipo de tejido granizo.

Laboratorio

Mesa

Línea

Individual

Producto

Pieza

Materias Primas

Paja toquilla

Paleta de Color

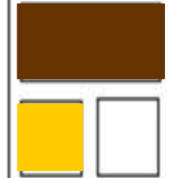

\$ 15000 unidad

Costo

Fecha

Boceto 1 de 1

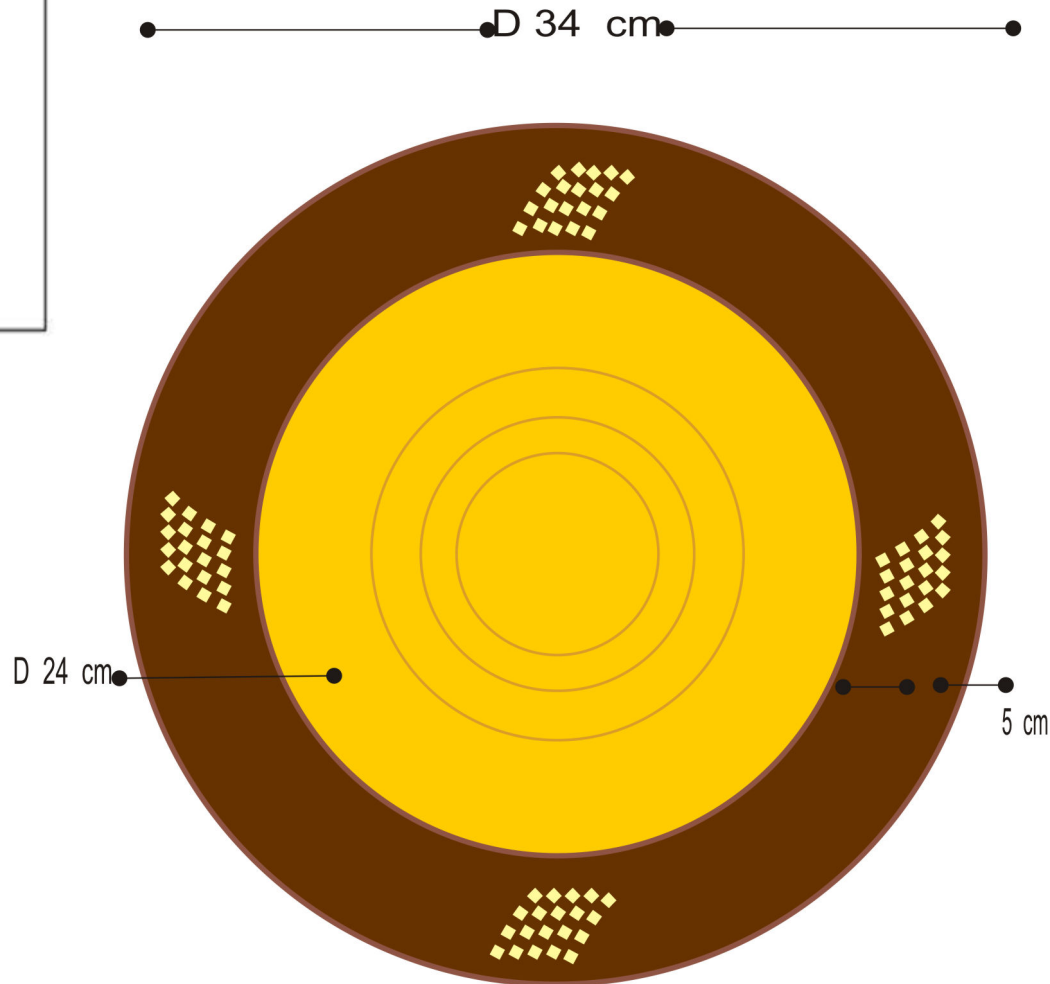
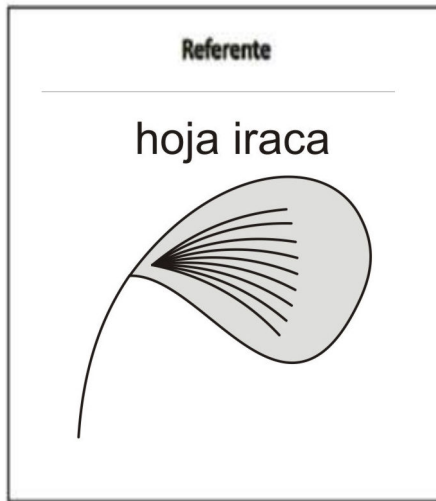

Tejido en paja gruesa con cambio de pajas de color amarillo a café ,tipo de tejido granizo.

Ficha Técnica

Laboratorio

Mesa

Línea

Juego individuales

Producto

Pieza

Materias Primas

Paja toquilla

Paleta de Color

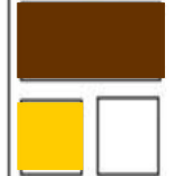

\$ 60000

Costo

Fecha

Boceto 1 de 1

Referente

hoja iraca

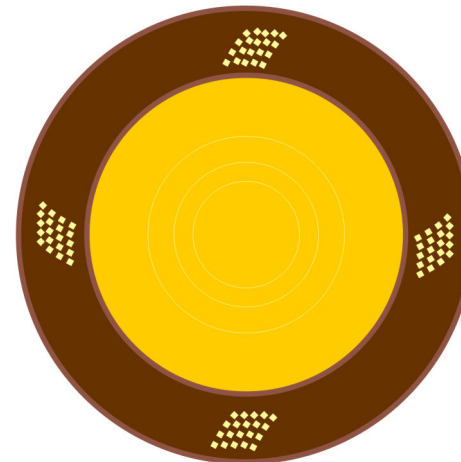
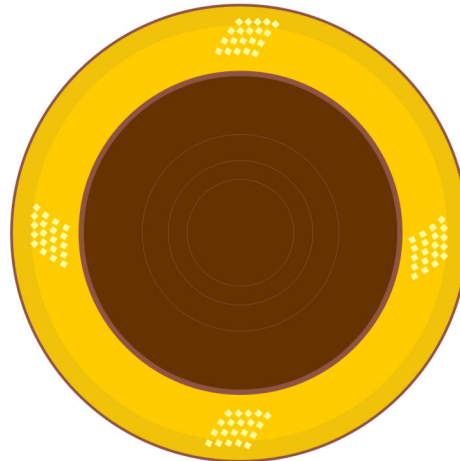
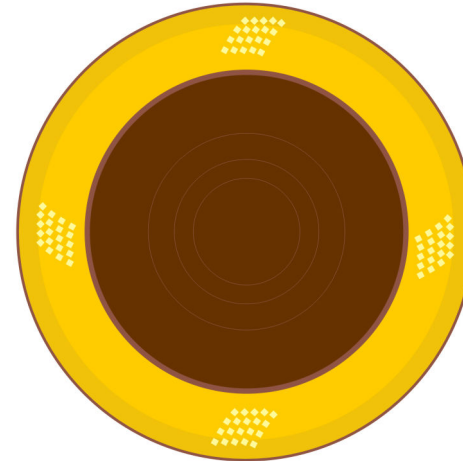
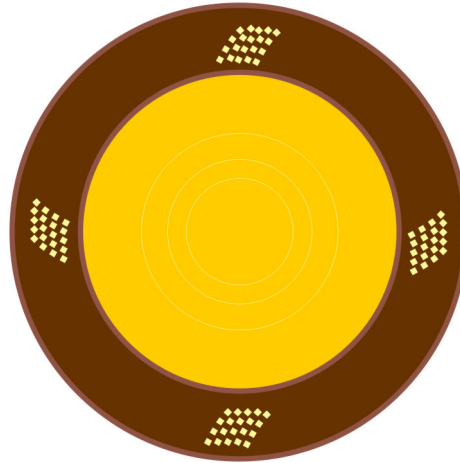
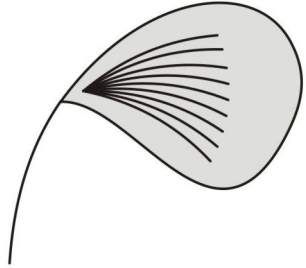

Ficha Técnica

Laboratorio

Sombreros

Línea

Pava niña

Producto

Pieza

Materias Primas

Paja toquilla, cuero aterciopelado

Paleta de Color



\$ 35000

Costo

Fecha

Boceto 1 de 1

Referente

Hoja floripondio

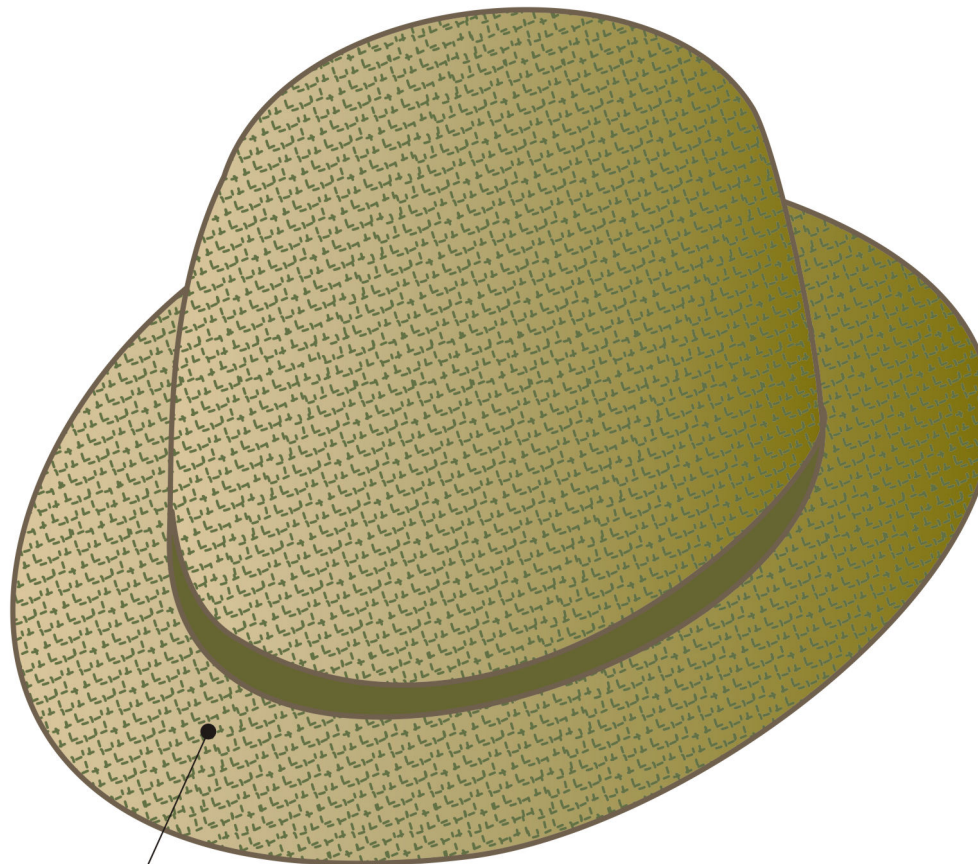
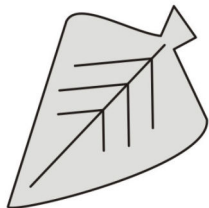

COPA 8 cm

6 cm
ALA

Tejido en paja fina con doble fibra color beige y verde oliva tipo de tejido granizo doble color .

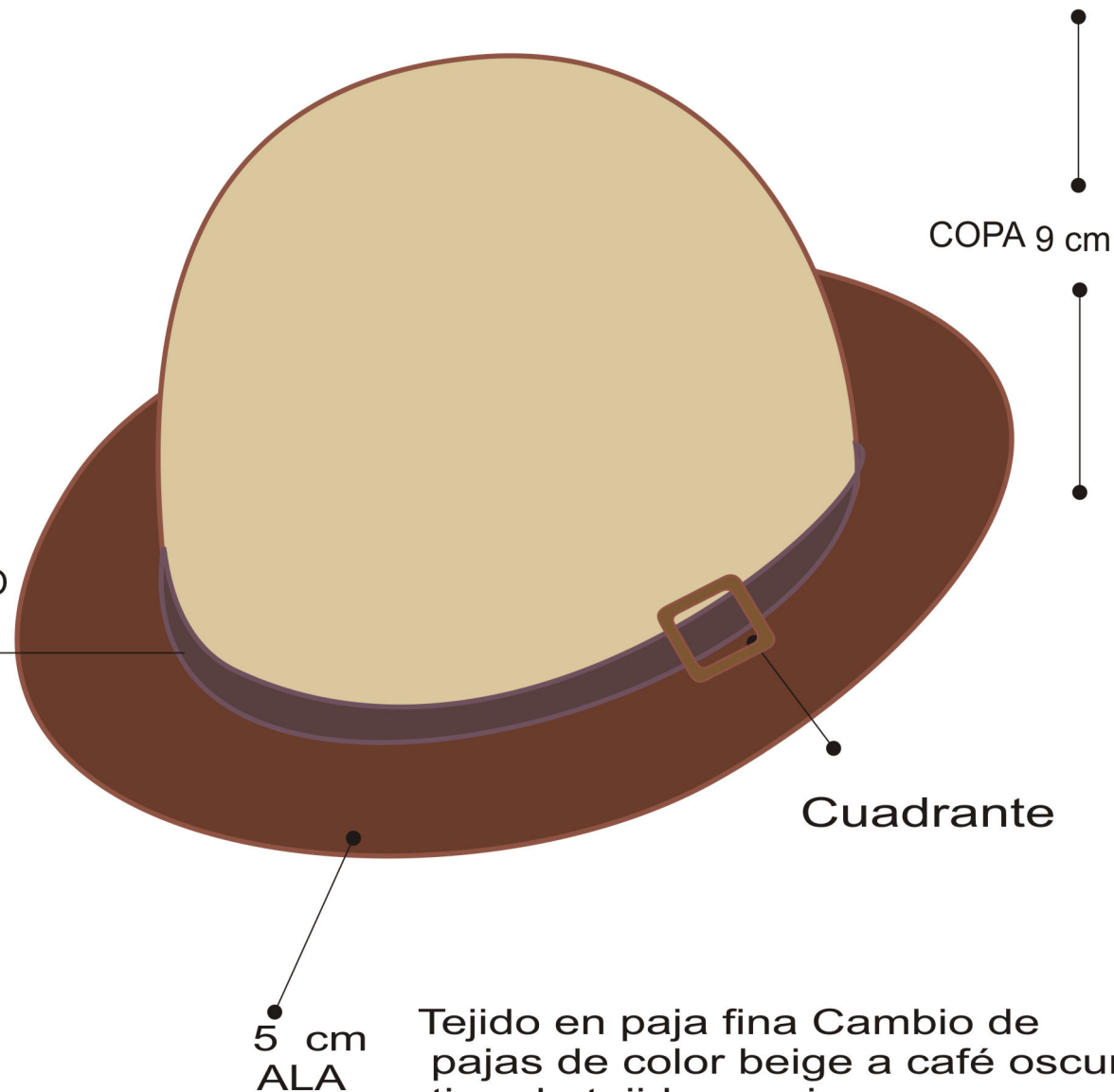

CUERO ATERCIOPELADO
57X 1CM

5 cm
ALA

COPA 9 cm

Cuadrante

Tejido en paja fina Cambio de pajas de color beige a café oscuro tipo de tejido granizo .

Ficha Técnica

Laboratorio

Sombreros

Línea

Sombrero dama

Producto

Pieza

Materias Primas

paja toquilla, cuero aterciopelado

Paleta de Color

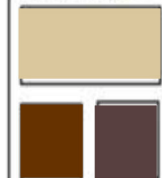

\$ 82000

Costo

Fecha

Boceto 1 de 1

Ficha Técnica

Laboratorio

Sombreros

Línea

Sombrero niño

Producto

Pieza

Materias Primas

Paja toquilla

Paleta de Color



\$ 35000

Costo

Fecha

Boceto 1 de 1

Referente

Hoja floripondio

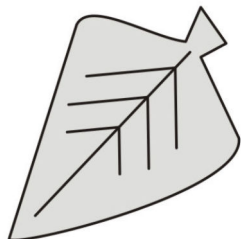

Calado

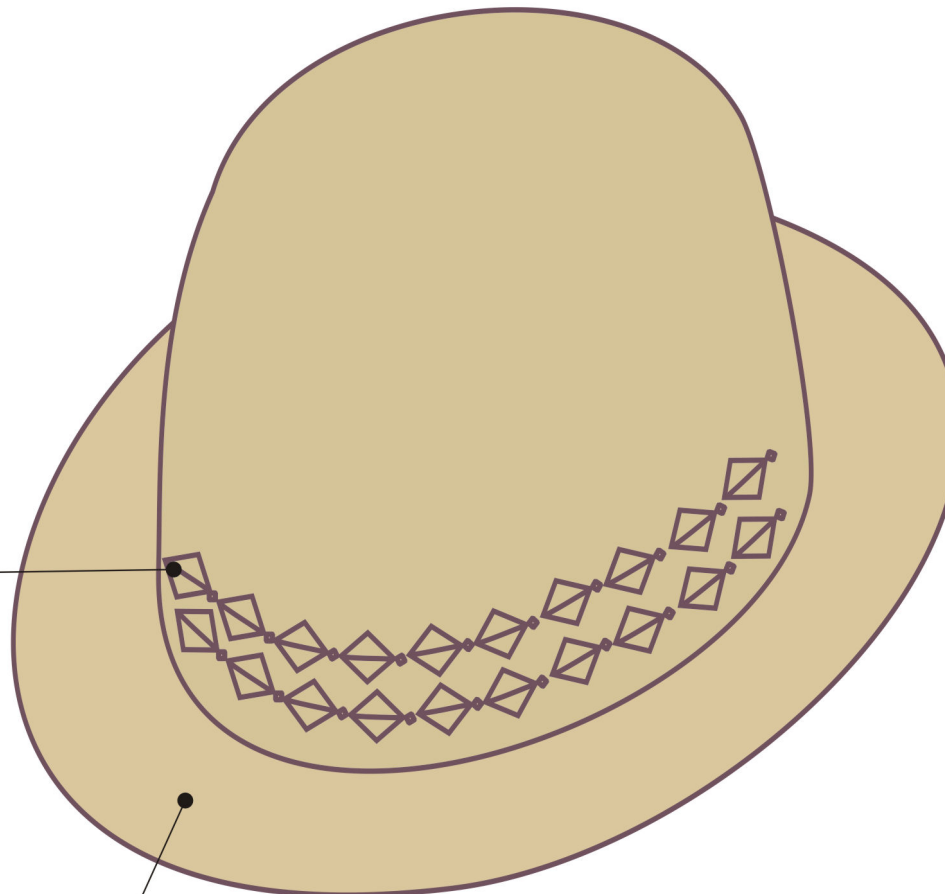

4 cm
ALA

Tejido en paja fina un solo color
 tipo de tejido granizo .

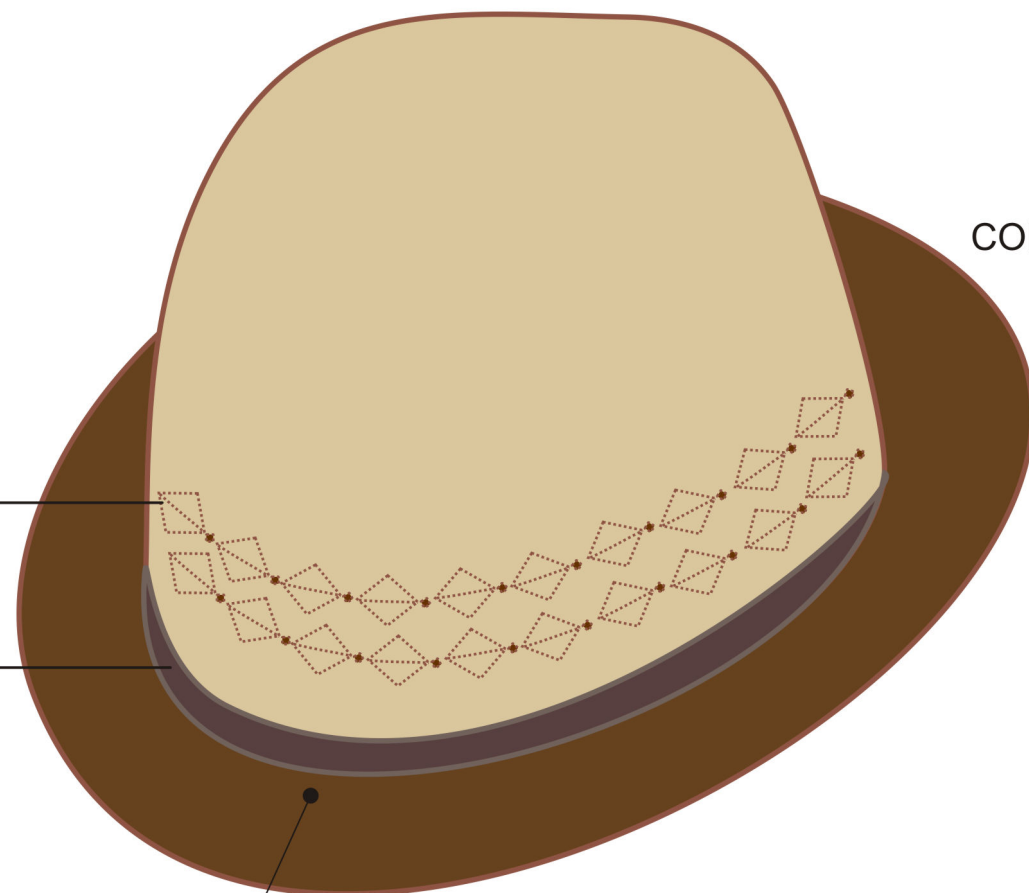

CUERO ATERCIOPELADO
 57X 1CM

5 cm
 ALA

Tejido en paja fina Cambio de pajas de color beige a café oscuro tipo de tejido granizo .

COPA 9 cm

Ficha Técnica

Laboratorio

Sombreros

Línea

Sombrero hombre

Producto

Pieza

Materias Primas

Paja toquilla, cuero aterciopelado

Paleta de Color



\$ 82000

Costo

Fecha

Boceto 1 de 1

Línea
accesorio Mujer
Producto

Pieza

Materias Primas

Hilo perla

Paleta de Color



\$25000

Costo

Fecha

Boceto 1 de 1

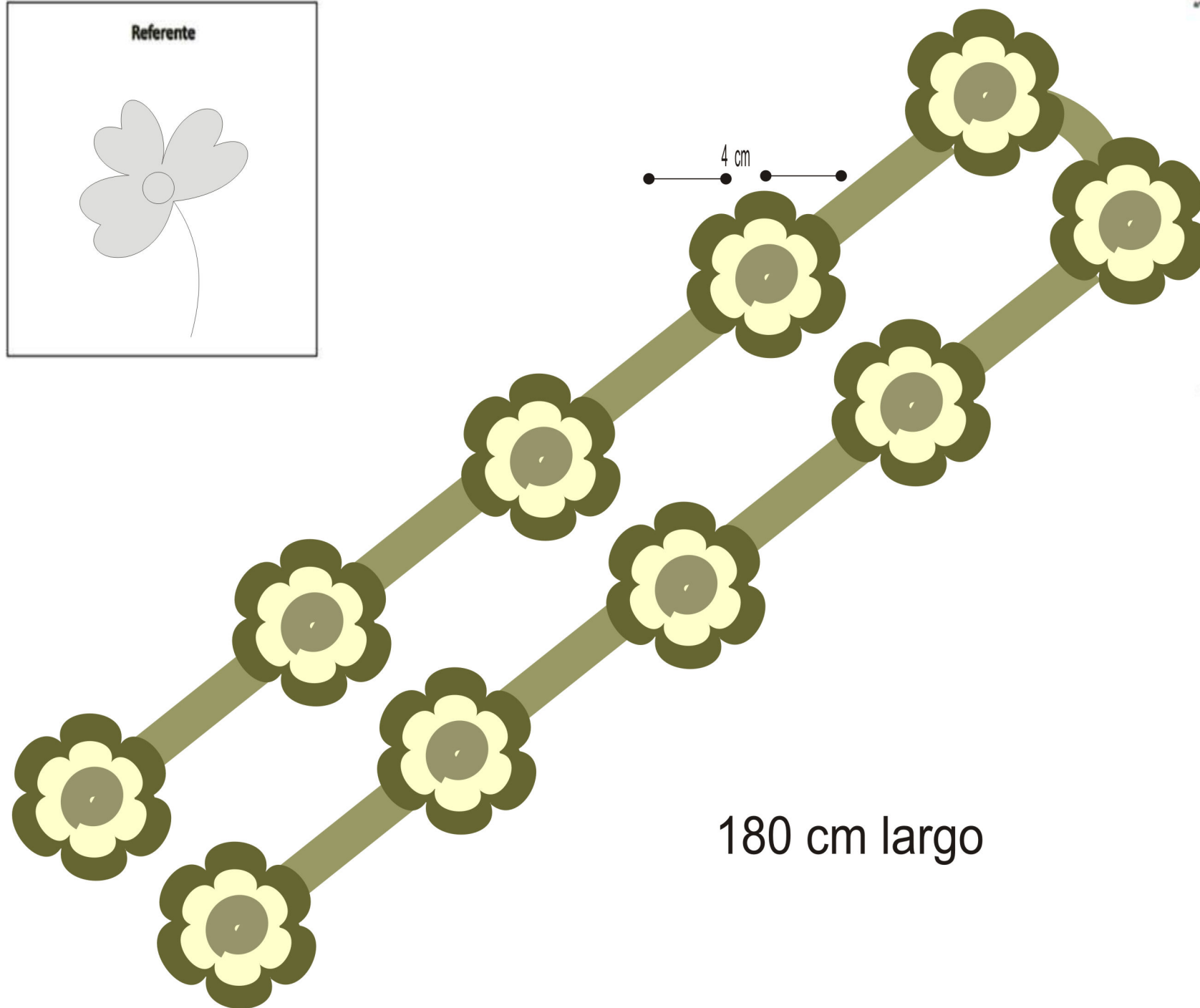
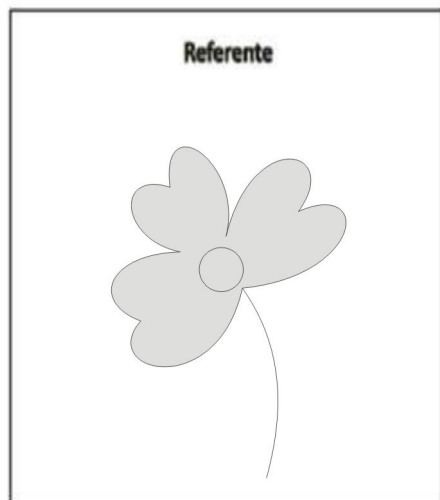

Ficha Técnica

Laboratorio

Bolsos

Línea

Bolso Cartera

Producto

Pieza

Materias Primas

Tela aterciopelada
 tela para forro, hilo
 líder, guata.

Paleta de Color



\$40000

Costo

Fecha

Boceto 1 de 1

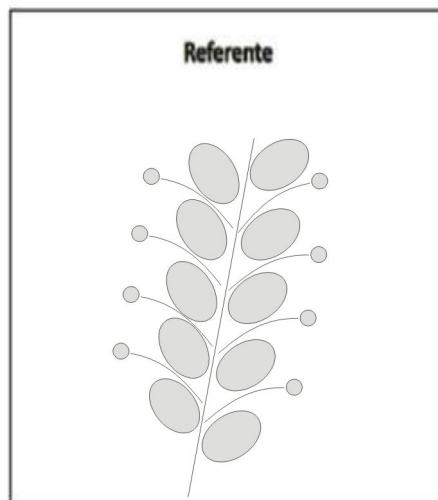

Muestra tejido croché
 5 *5 cm

Ficha Técnica

Laboratorio

Bolsos

Línea

Bolso playero

Producto

Pieza

Materias Primas

Tela aterciopelada
tela para forro, hilo
líder, guata.

Paleta de Color



\$45000

Costo

Fecha

Boceto 1 de 1

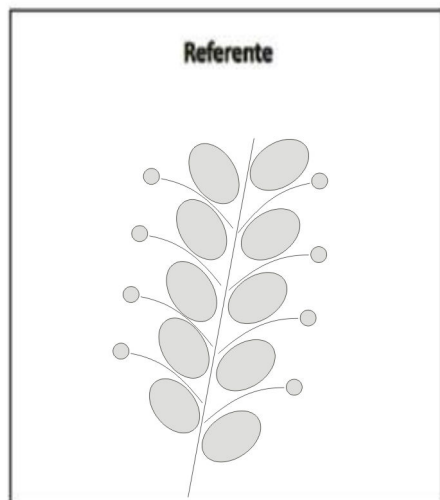

Muestra tejido croché
5 *5 cm



Ficha Técnica

Laboratorio

Bolsos

Línea

Bolso pequeño

Producto

Pieza

Materias Primas

Tela aterciopelada
tela para forro, hilo
lider, guata.

Paleta de Color



\$40000

Costo

Fecha

Boceto 1 de 1

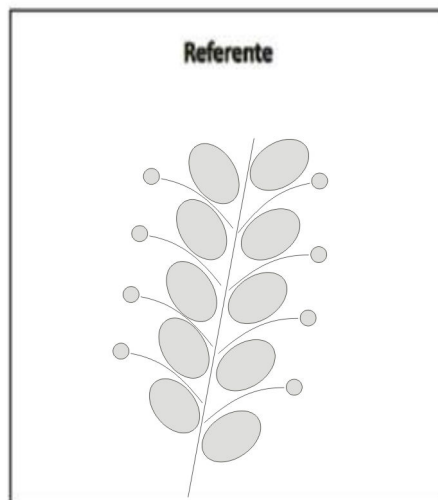

Muestra tejido croché
4 *4 cm

21 cm



25 cm

Ficha Técnica

Laboratorio

Accesorios personales

Línea

Bufanda

Producto

Pieza

Materias Primas

Lana Jazmín
matizada

Paleta de Color



\$25000

Costo

Fecha

Boceto 1 de 1

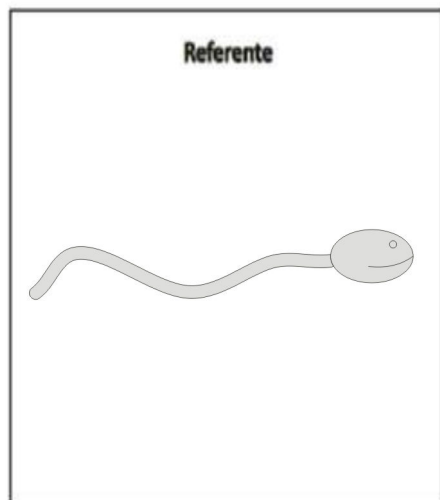

180 cm largo * 20 cm ancho

Ficha Técnica

Laboratorio

Home decor

Línea

Camino de mesa

Producto

Pieza

Materias Primas

Lana bebe, tela aterciopelada

Paleta de Color



\$30000

Costo

Fecha

Boceto 1 de 1

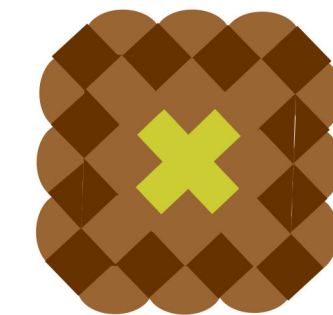
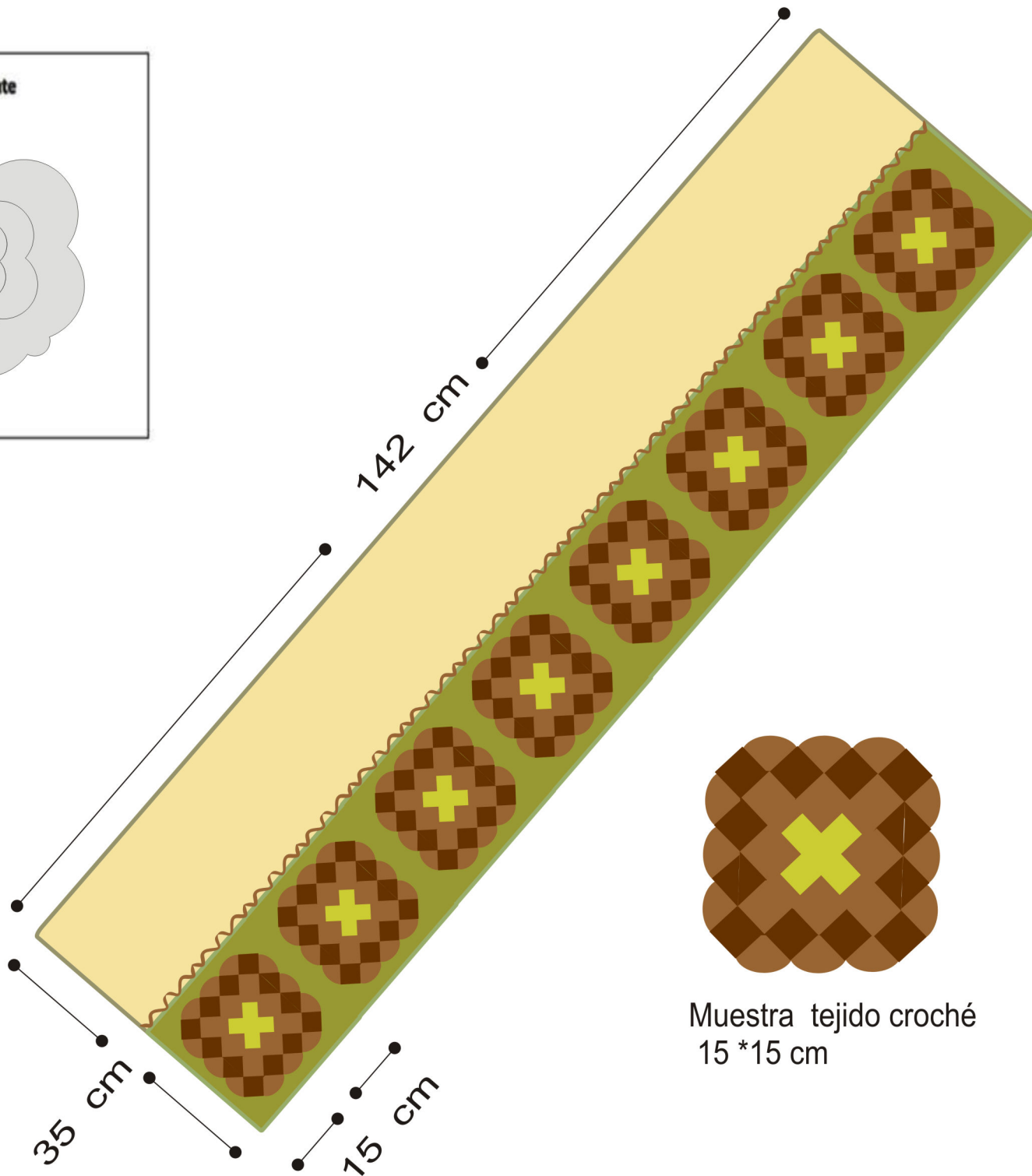
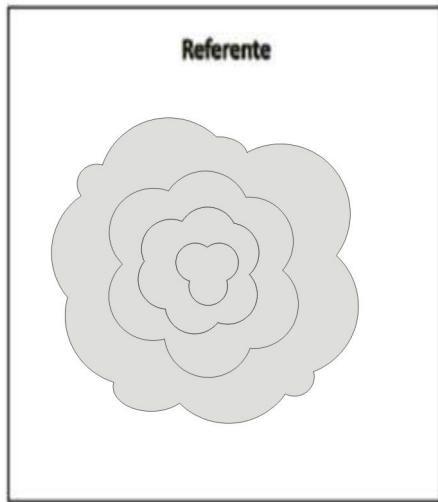

Muestra tejido croché
15 *15 cm

Ficha Técnica

Laboratorio

Accesorios personales

Línea

Chal

Producto

Pieza

70 cm

Materias Primas

Lana Jazmín
matizada

Paleta de Color



\$80000

Costo

Fecha

Boceto 1 de 1

Referente

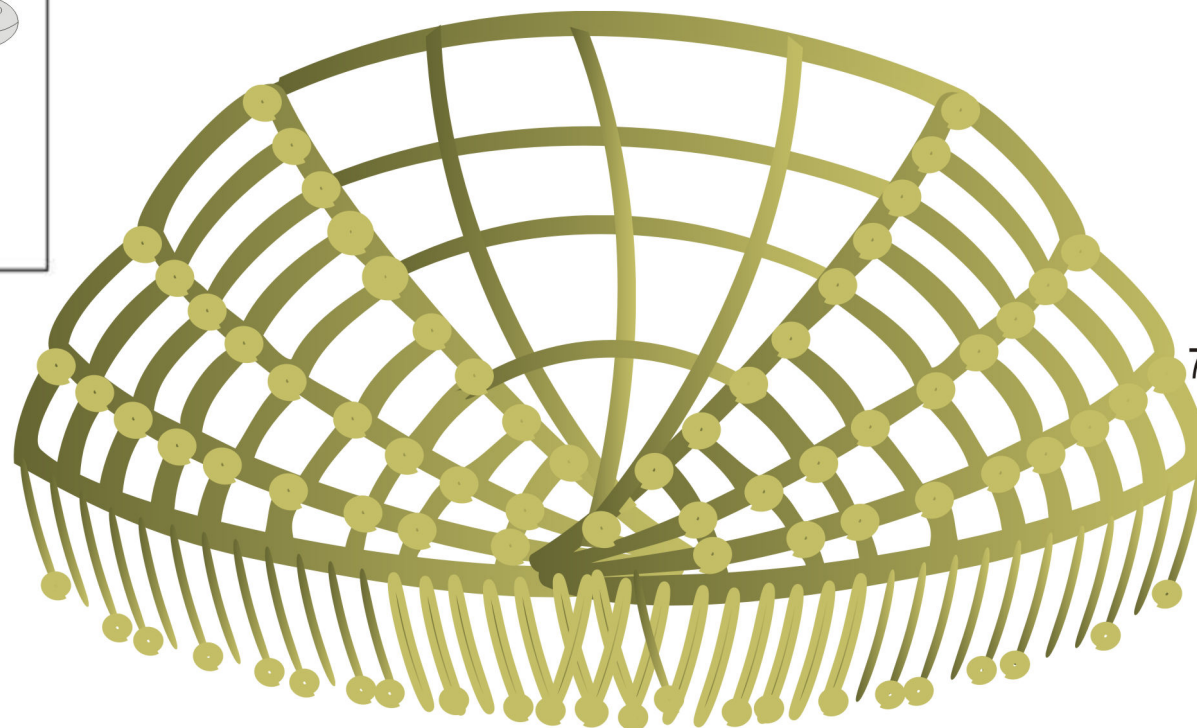

140 cm

Ficha Técnica

Laboratorio

Home decor

Línea

Cojín

Producto

Pieza

Materias Primas

Lana bebe, tela Aterciopelada

Paleta de Color



\$25000

Costo

Fecha

Boceto 1 de 1

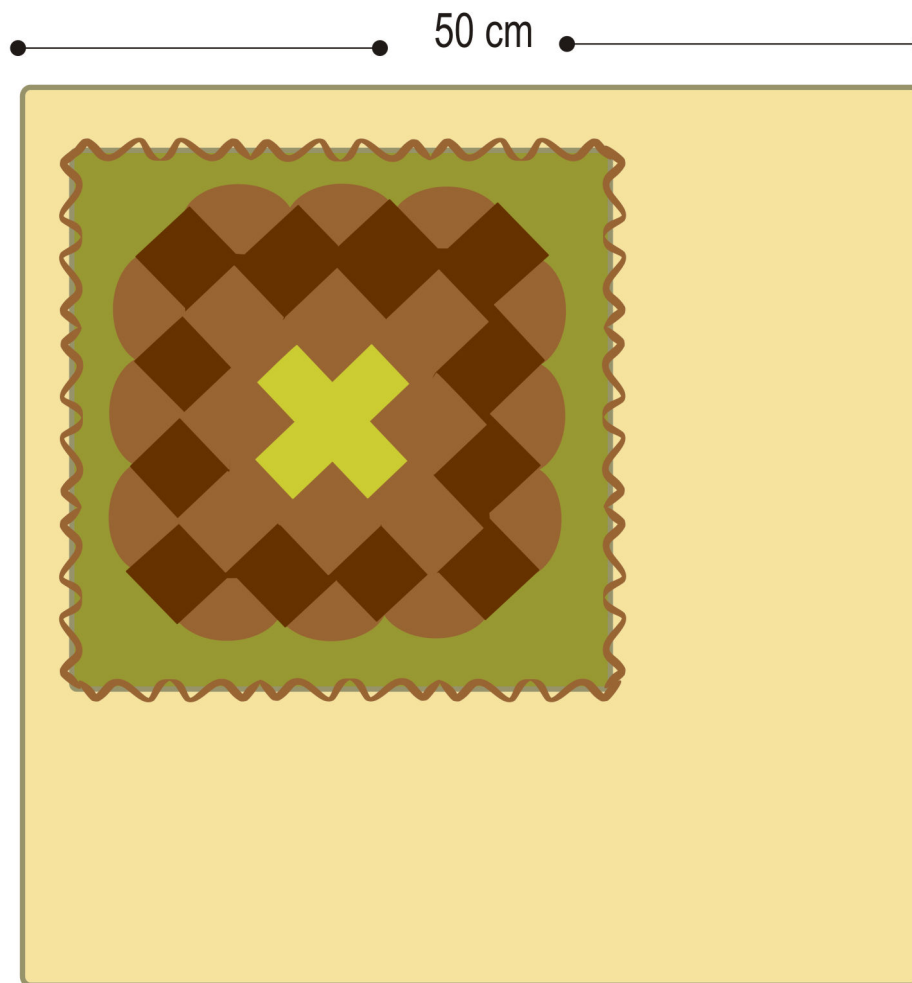
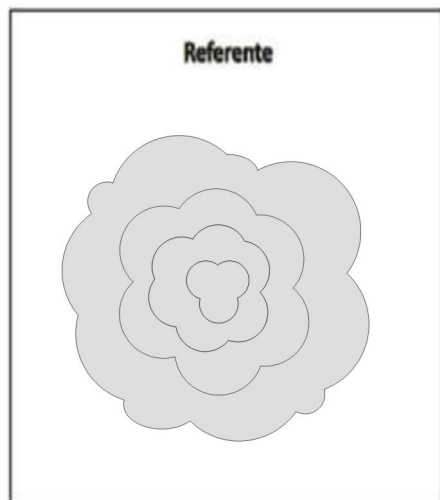

50 cm

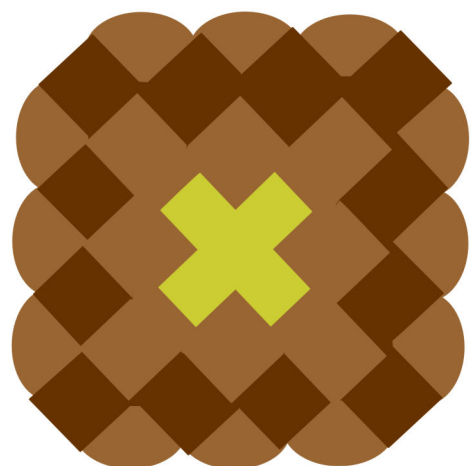

25 cm

30 cm

Muestra tejido croché 25 *25 cm

Ficha Técnica

Laboratorio

Accesorios personales

Línea

Cuello

Producto

Pieza

Materias Primas

Lana Jazmín

Paleta de Color



\$25000

Costo

Fecha

Boceto 1 de 1

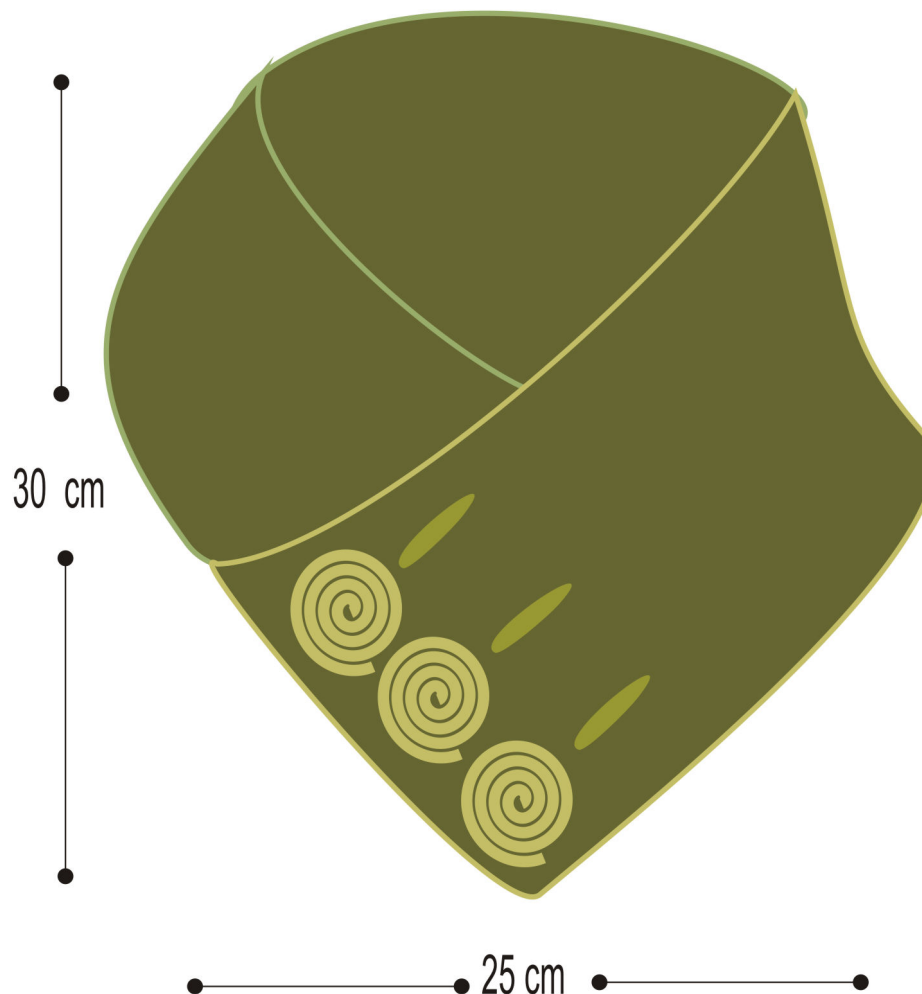
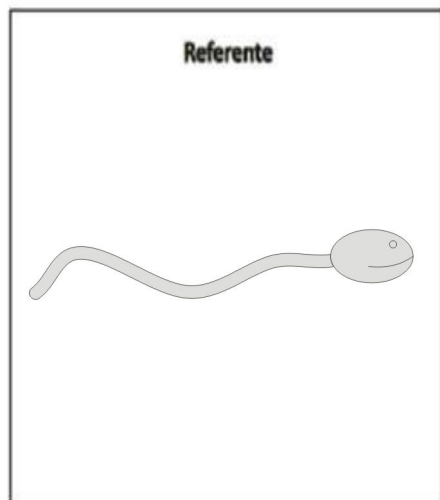

Ficha Técnica

Laboratorio

Accesorios personales

Línea

Bufanda

Producto

Pieza

Materias Primas

Hilo líder

Paleta de Color

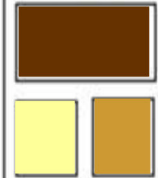

\$35000

Costo

Fecha

Boceto 1 de 1

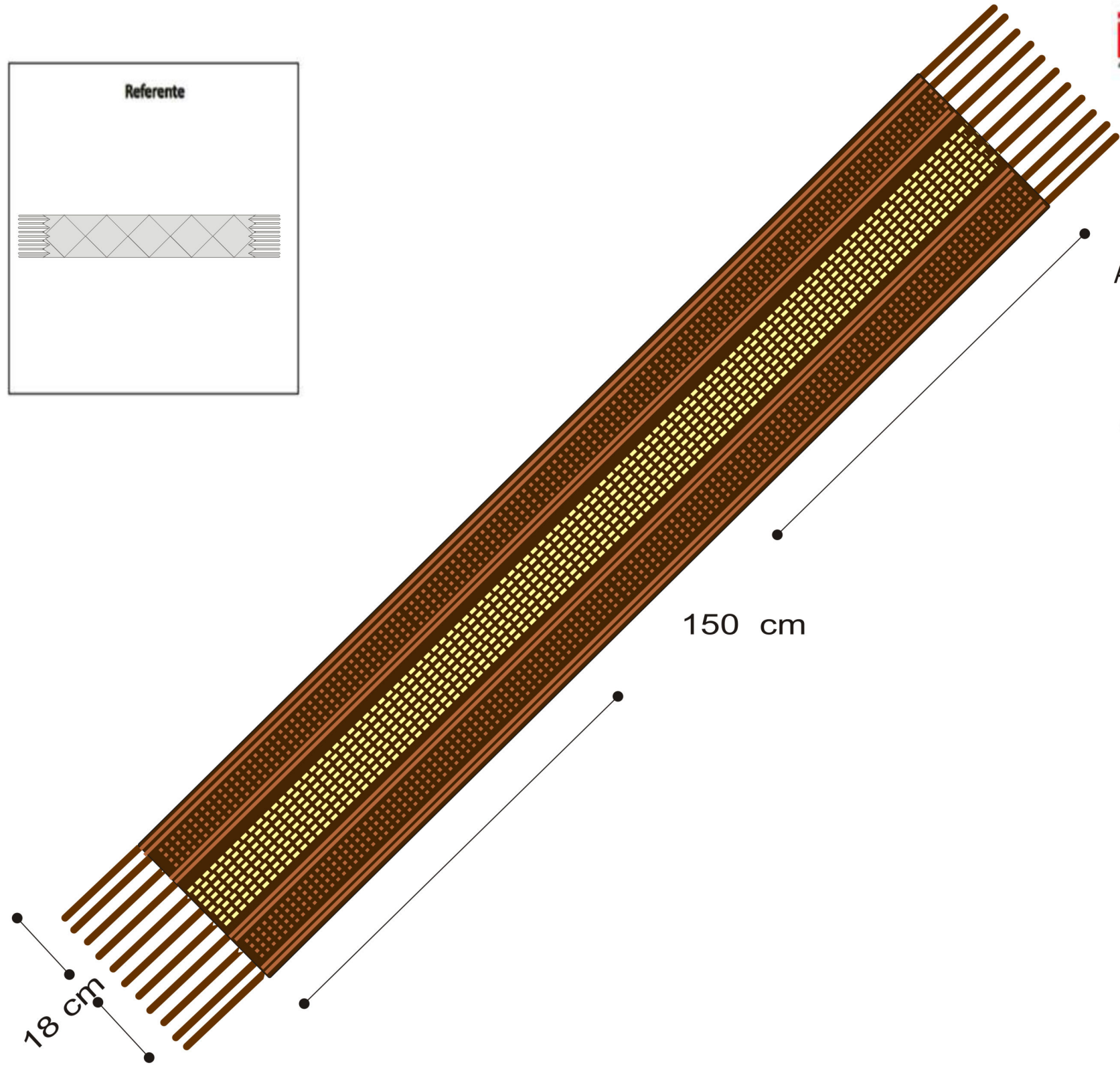
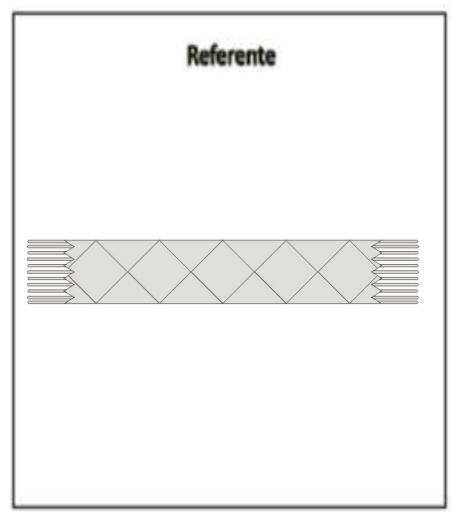

Ficha Técnica

Laboratorio

Home decor
 Línea

Cojín
 Producto

Pieza

Materias Primas
 Hilo lider

Paleta de Color

\$56000
 Costo

Fecha

Boceto 1 de 1

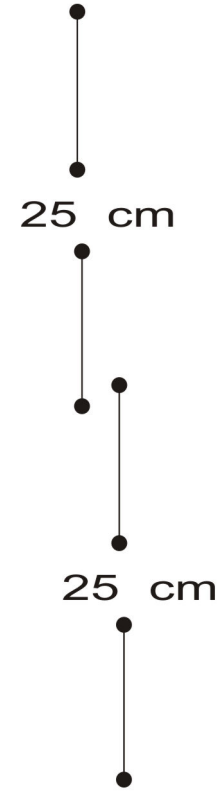
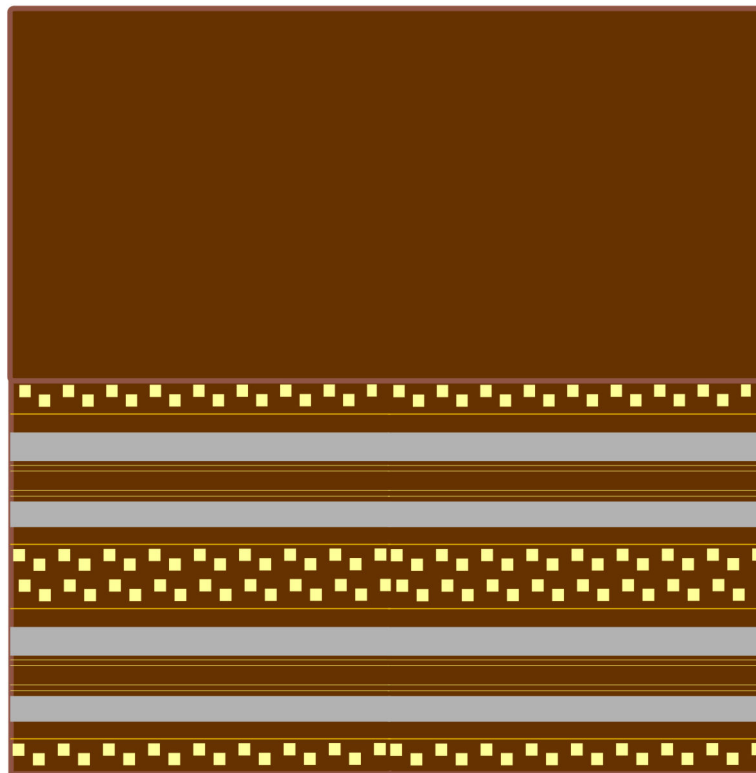
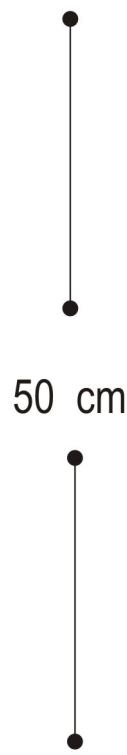
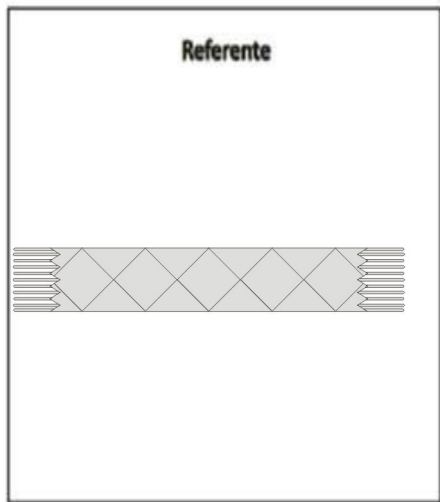

Tejido en Guanga

Anexos:

Bocetos municipios la Florida, San pedro de Cartago, Santacruz de Guachavez, Tablón de Gómez.

1. Municipio de la Florida:

Referentes:

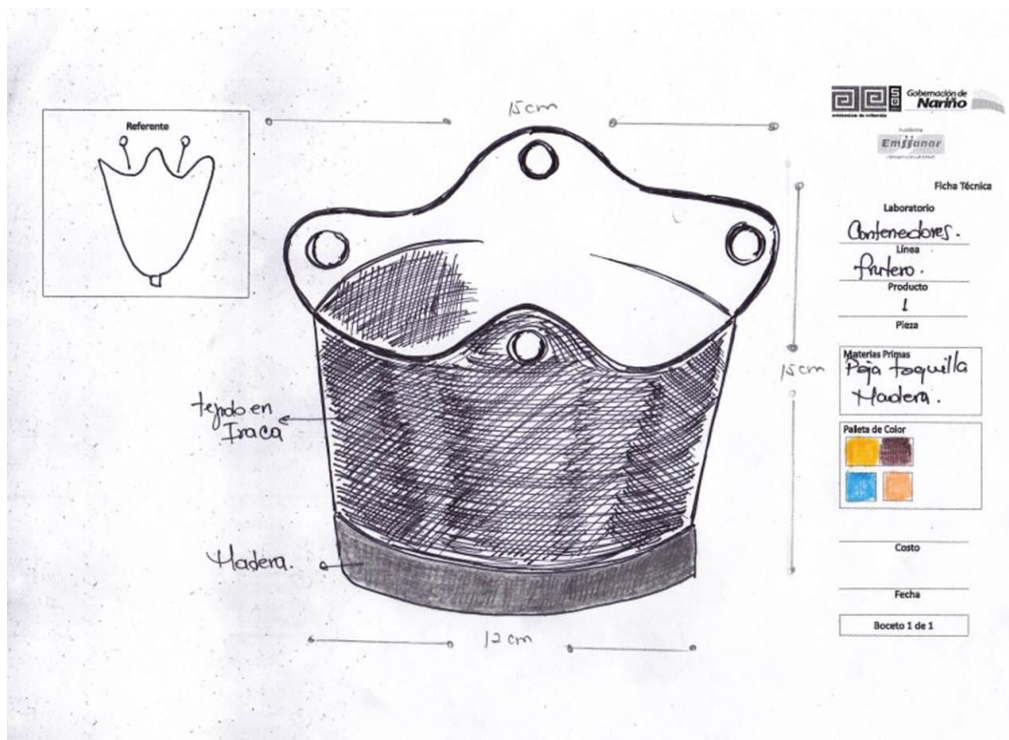

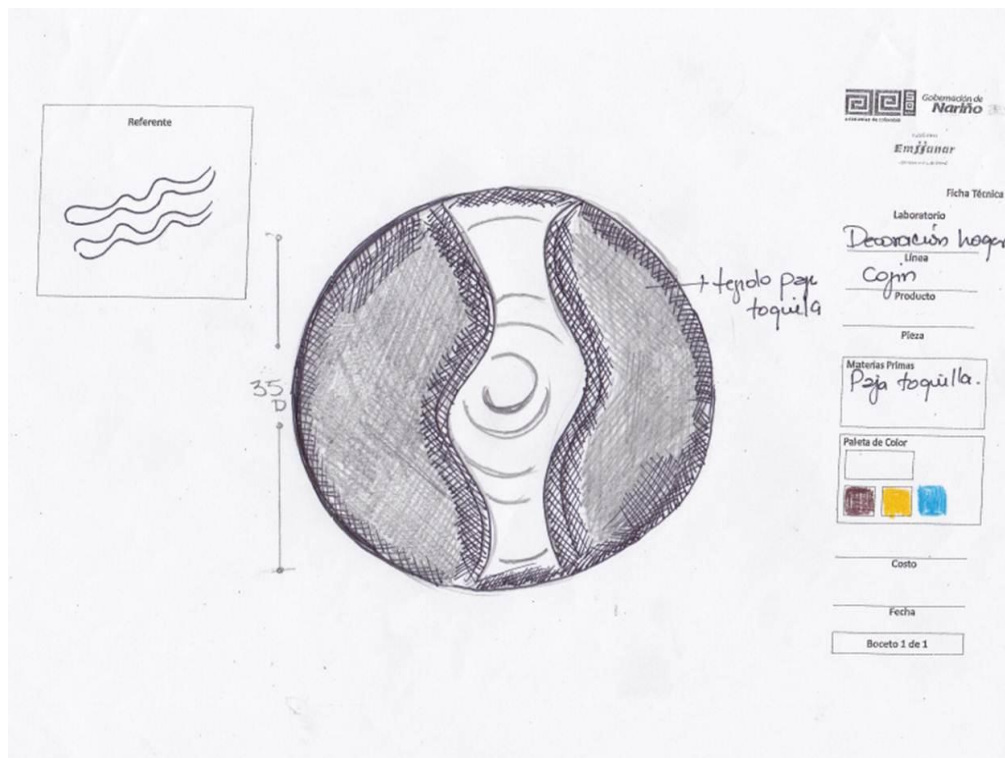
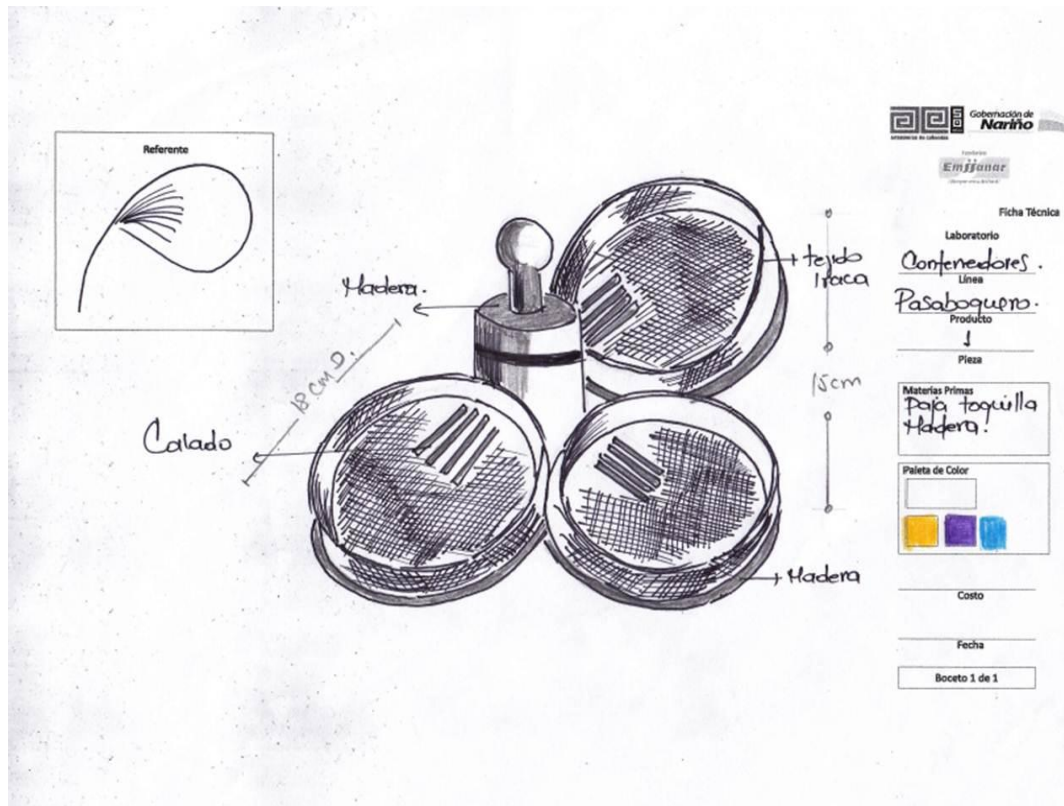

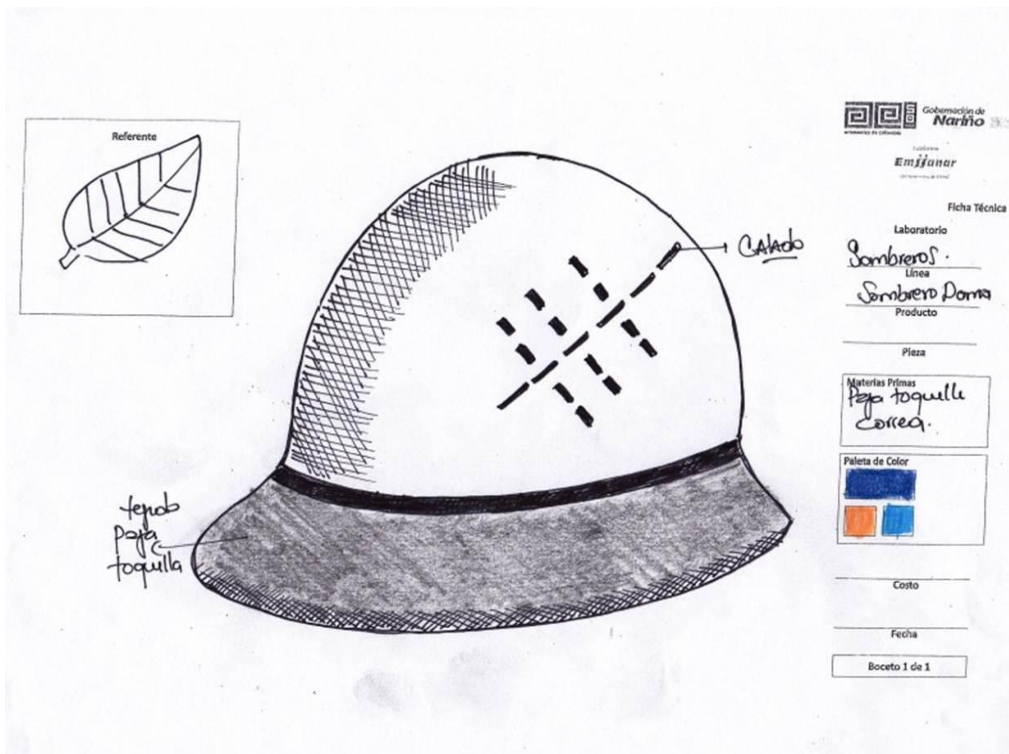
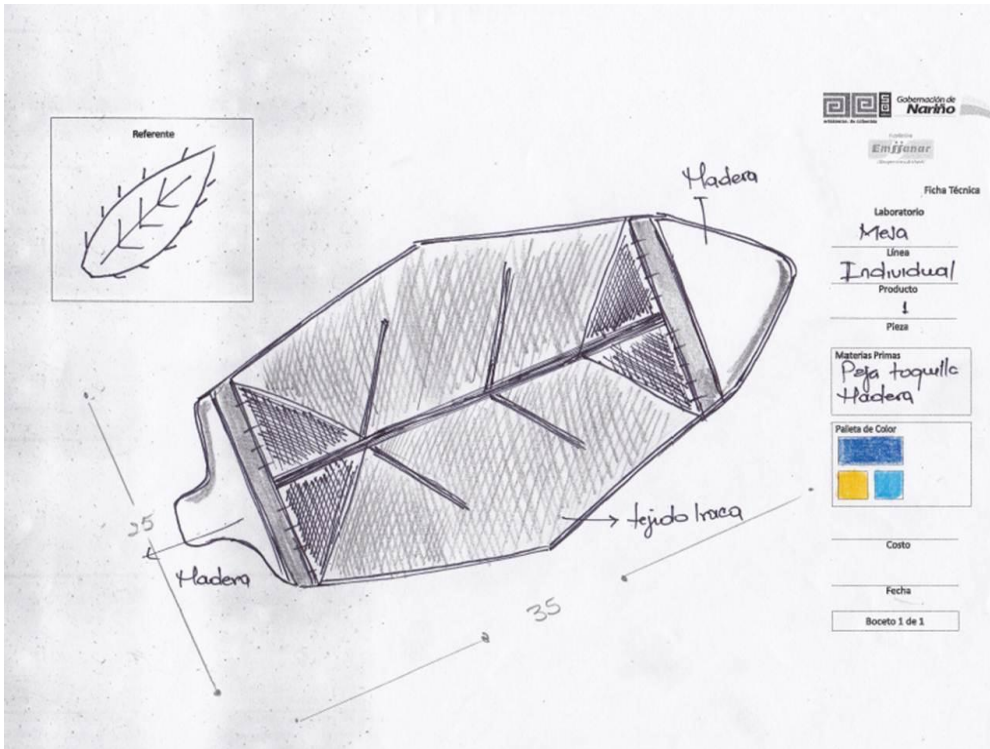

2. Municipio San Pedro de Cartago: Referentes:

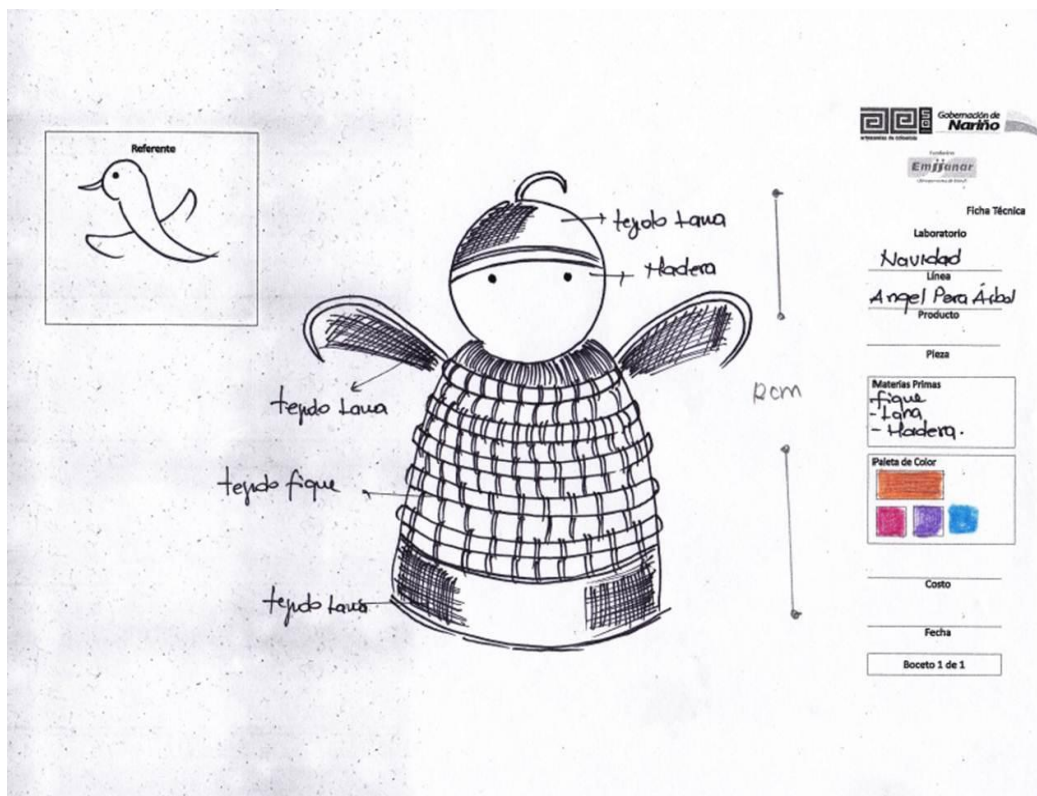
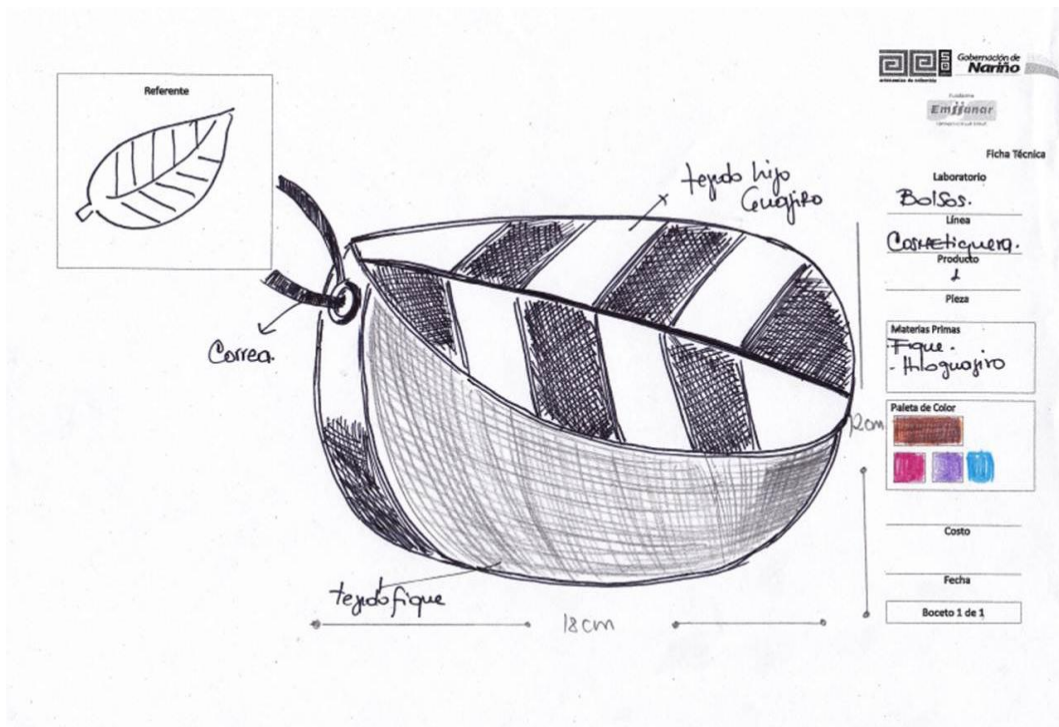
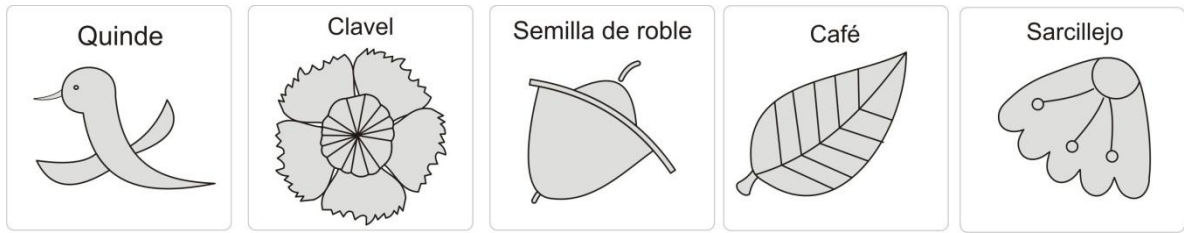

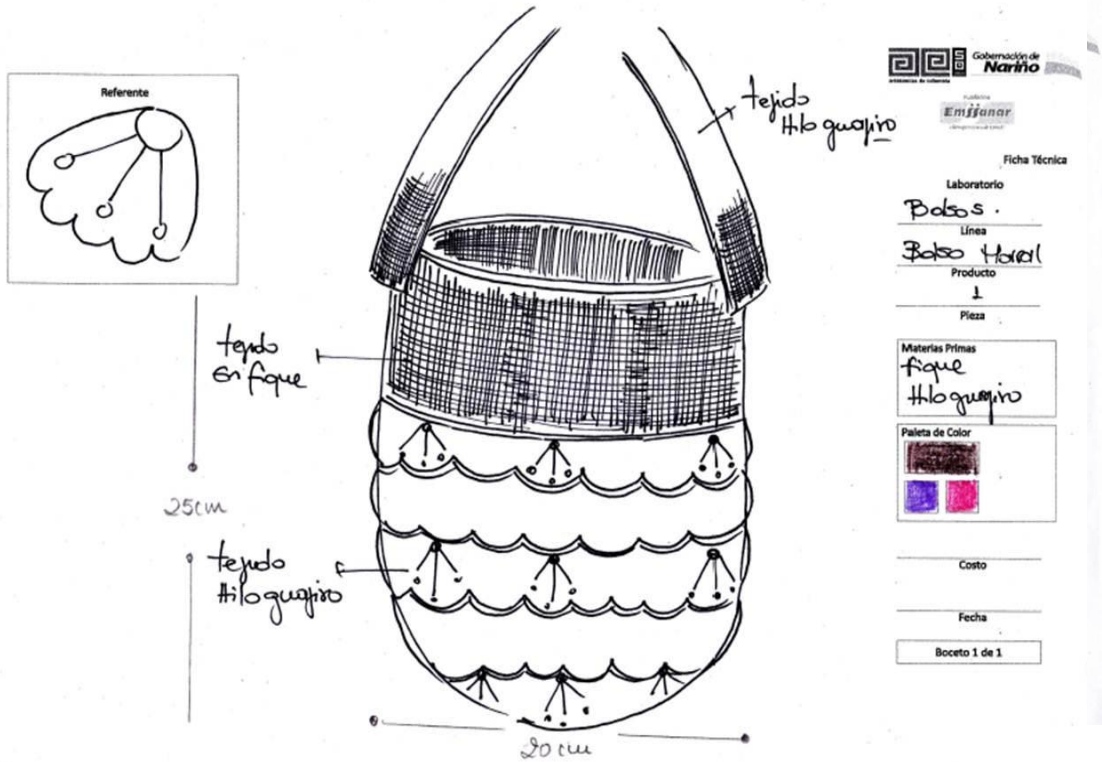
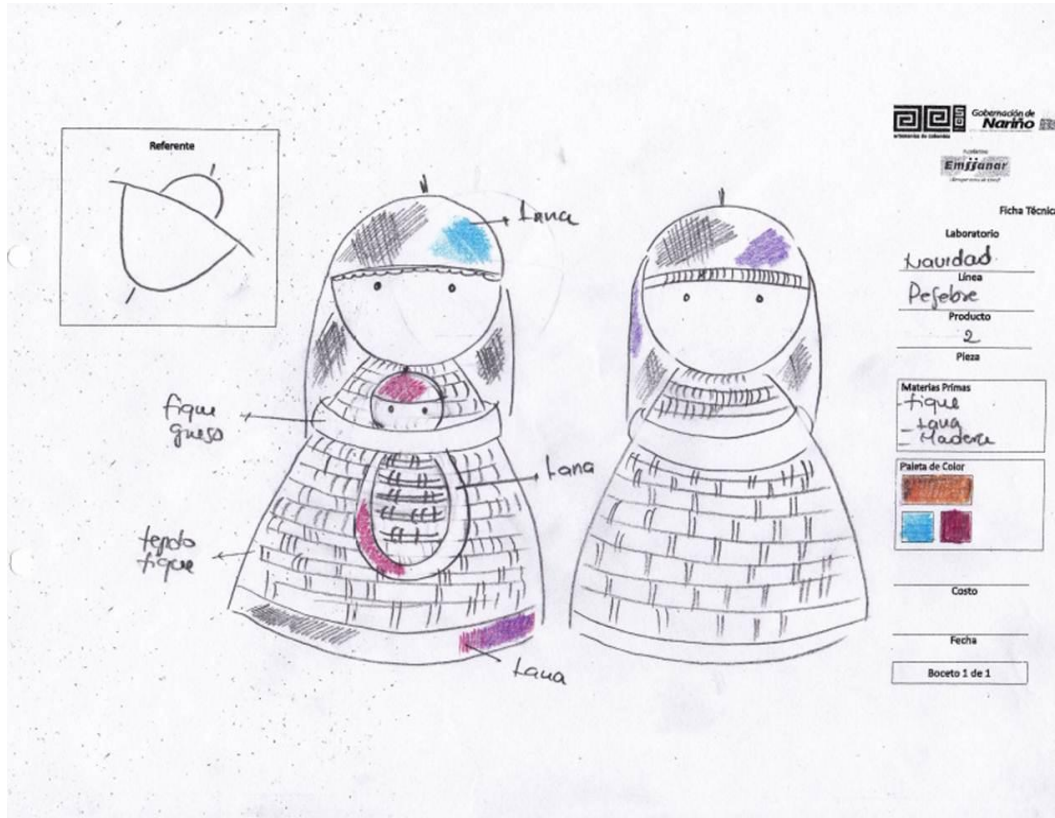

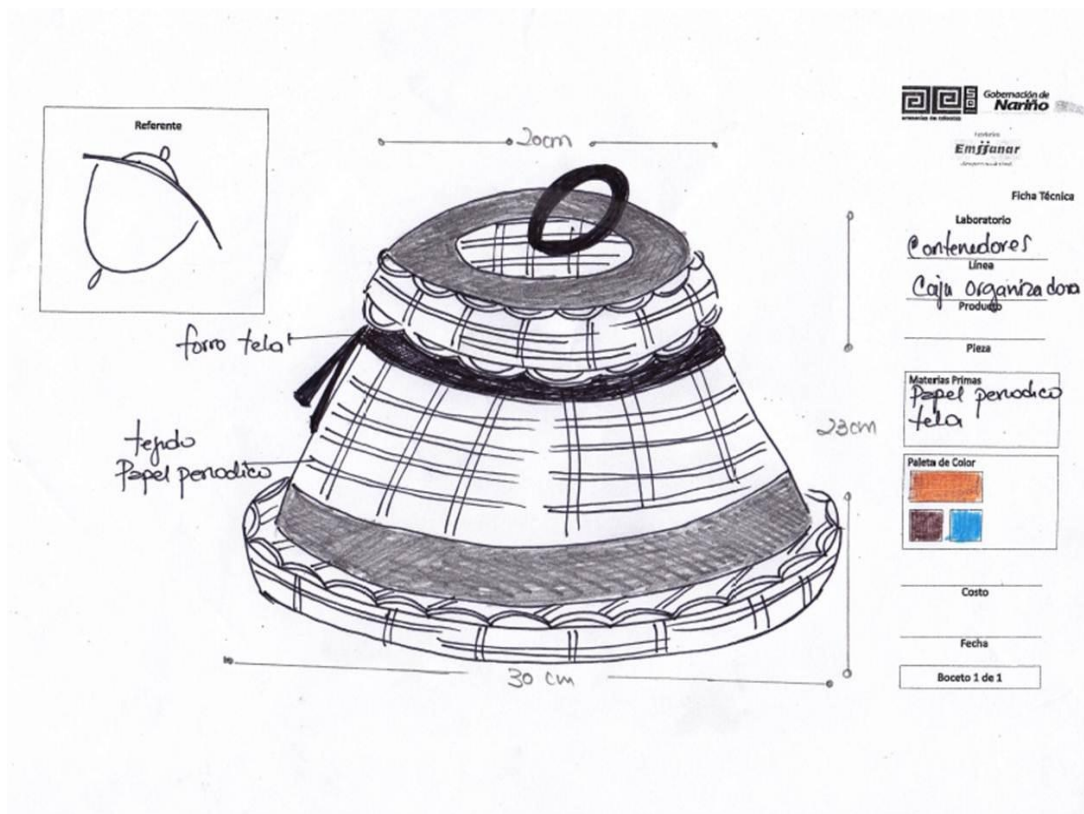

3. Municipio Tablón de Gómez: Referentes:

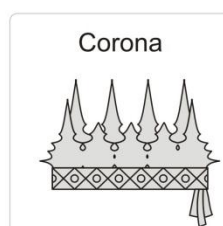
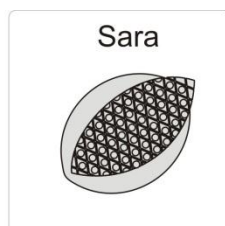
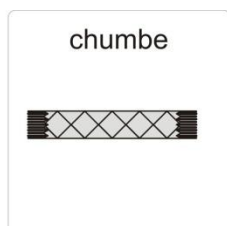
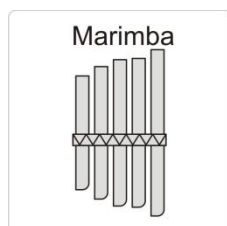

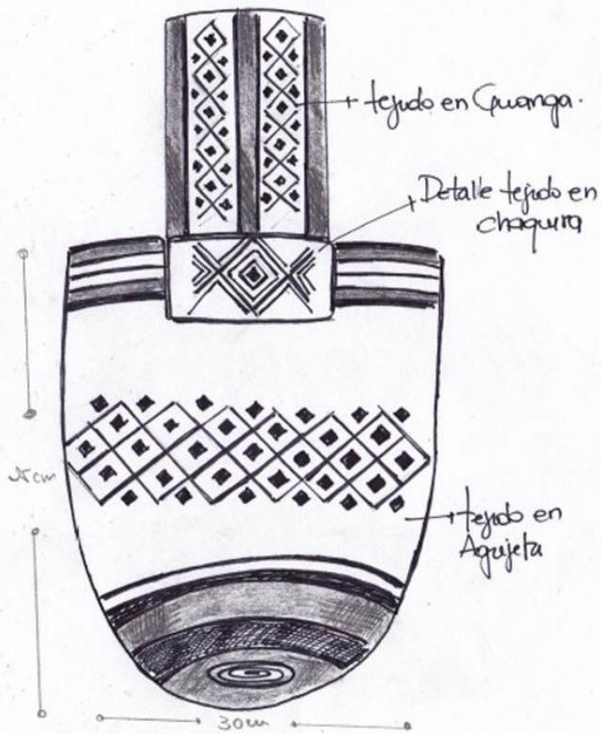
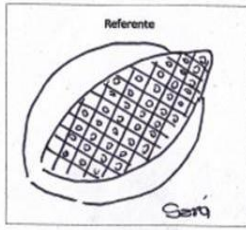

Bolsos

Línea

Hechura

Producto

Pieza

Materias Primas

Jana - chaquirá

Paleta de Color



Costo

Fecha

Boceto 1 de 1

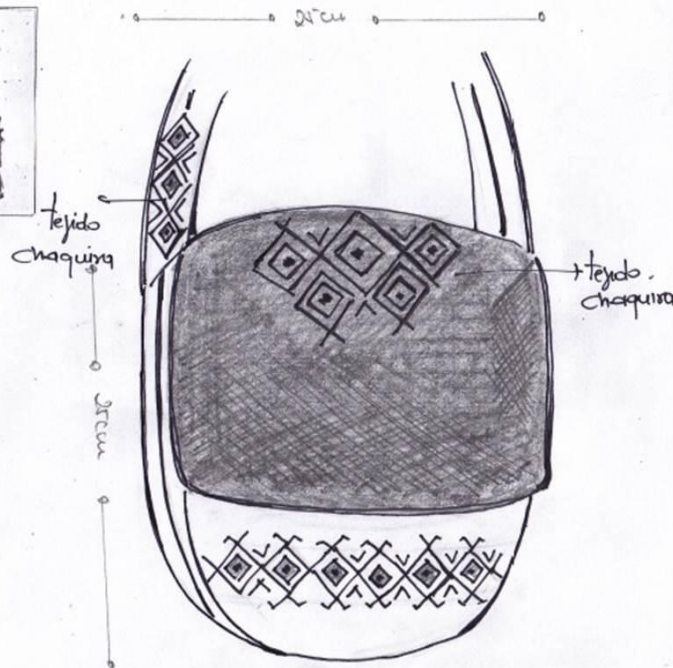

Bolsos

Línea

Bolso

Producto

Pieza

Materias Primas

Paleta de Color



Costo

Fecha

Boceto 1 de 1

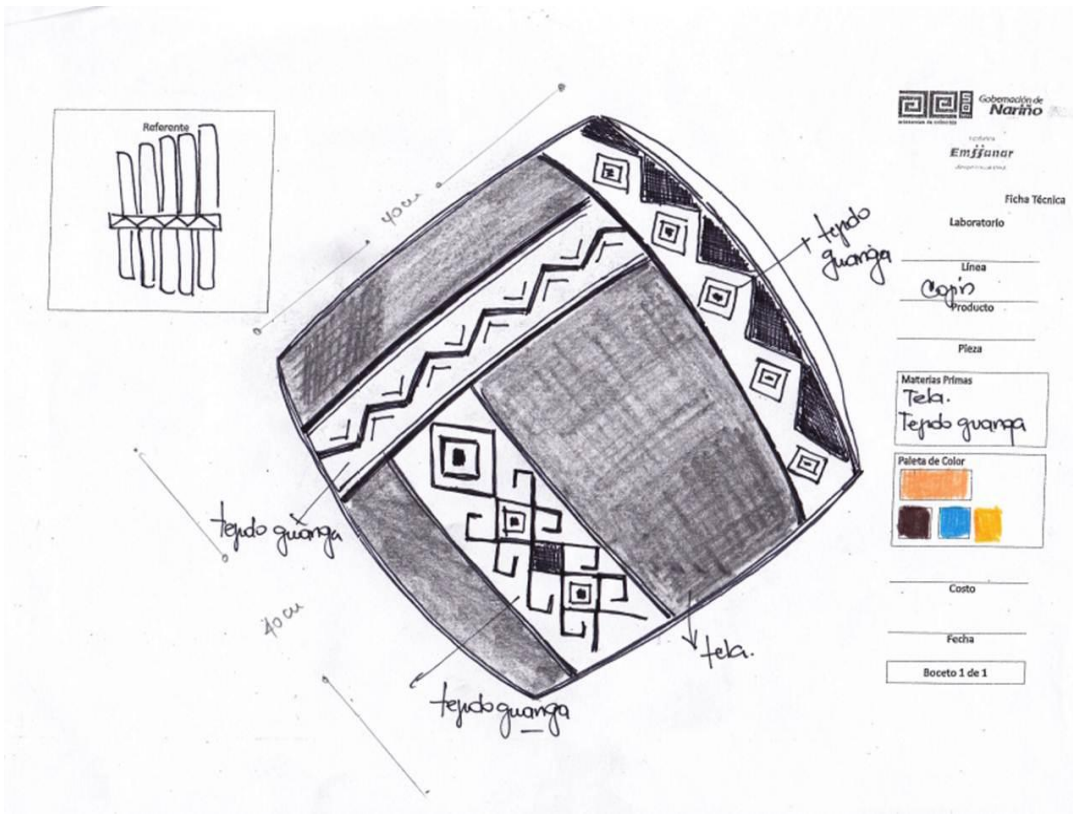
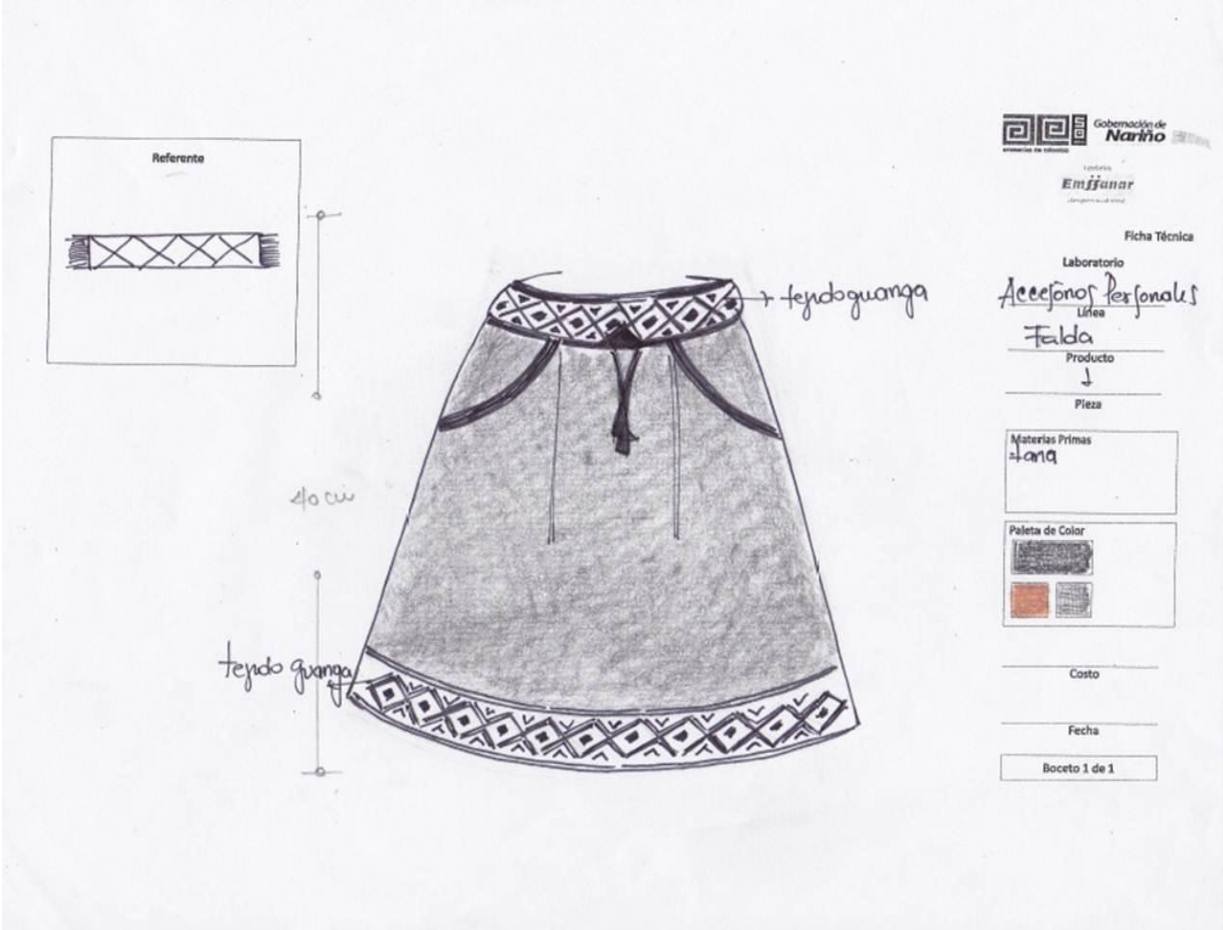

**4. Municipio Santacruz de Guachavez:
Referentes:**

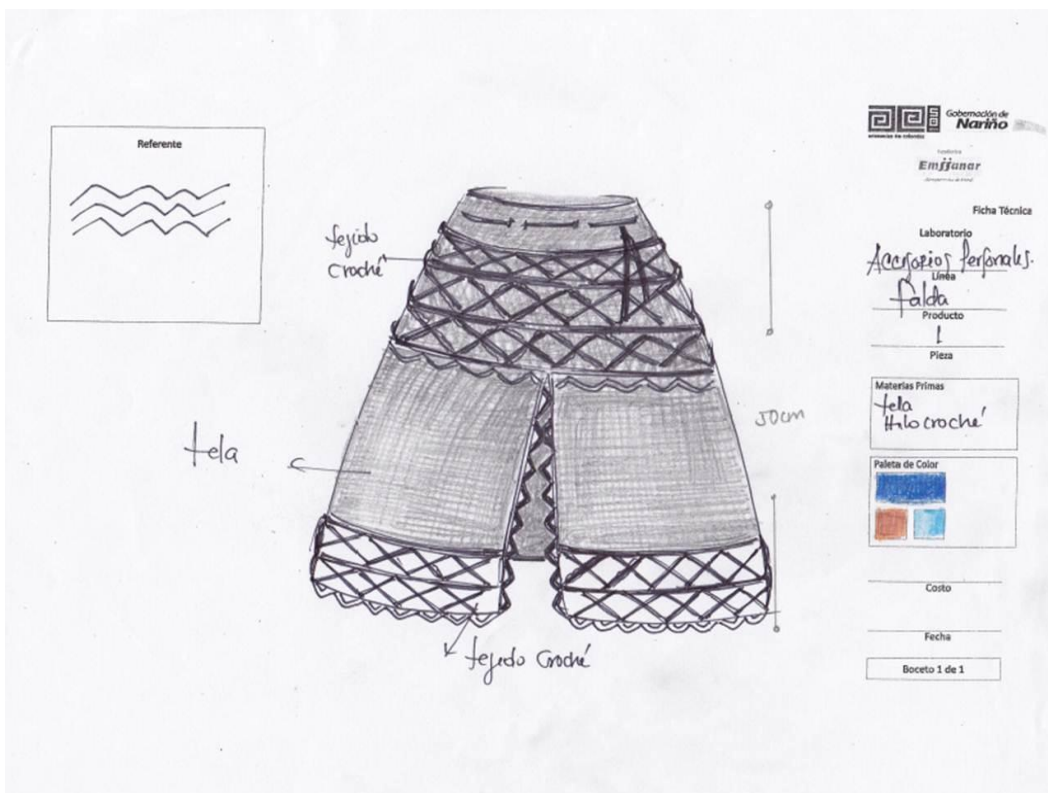
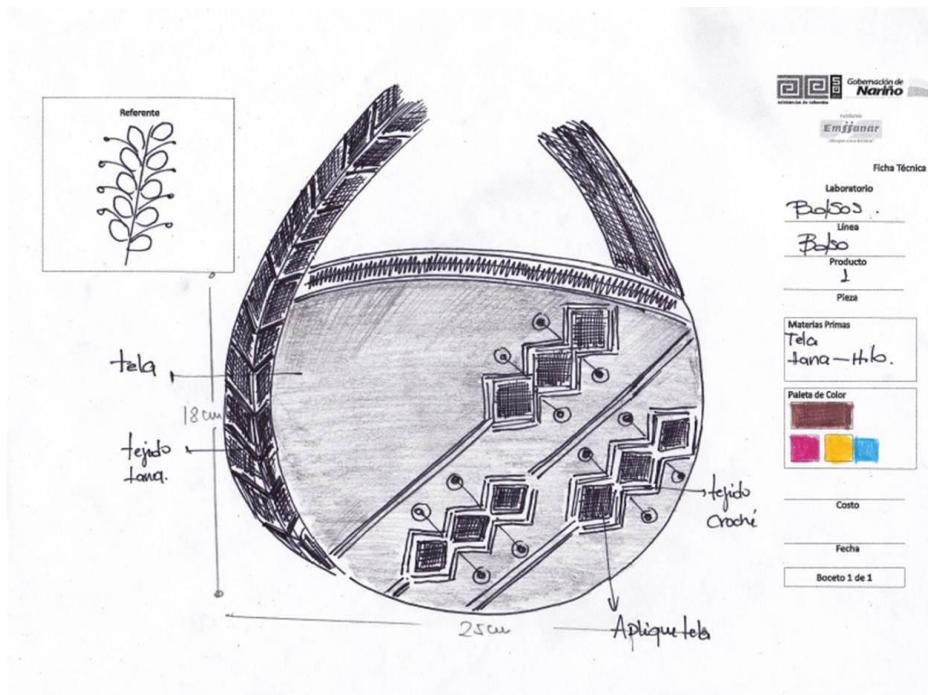

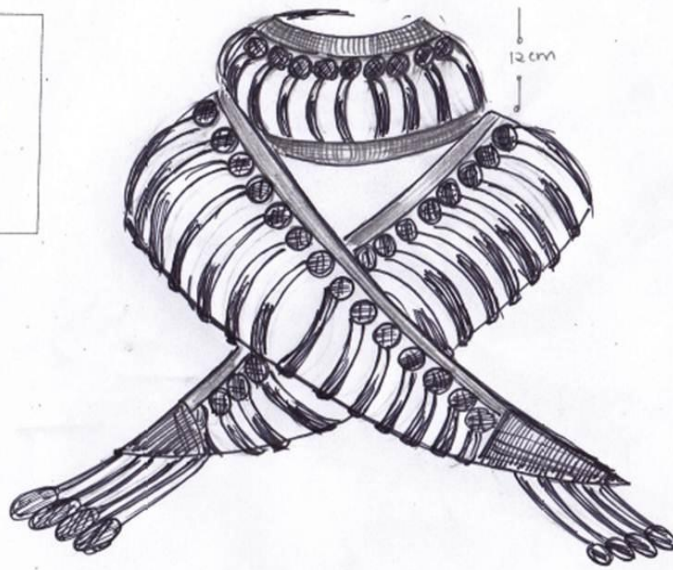
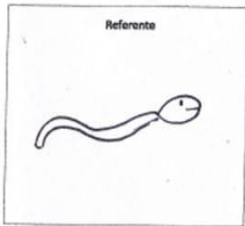

Laboratorio
Aracinos Personales
 Línea
Bafanda
 Producto
 1
 Pieza

Materias Primas
Hilo Croché



Costo

Fecha

Boceto 1 de 1

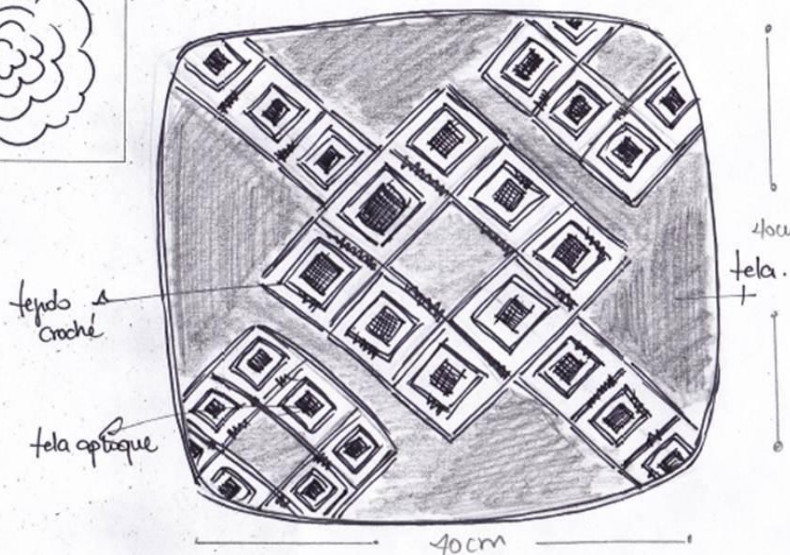
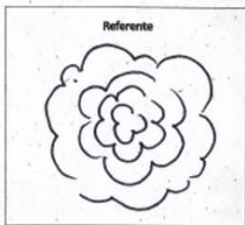

Laboratorio
Decoracion Cap
 Línea
Funda Capin
 Producto
 1
 Pieza

Materias Primas
*Tela
 tela aplique
 lana Croché*



Costo

Fecha

Boceto 1 de 1