



Formulario de programas y proyectos

Fortalecimiento de los procesos artesanales productivos y culturales de las mujeres artesanas del departamento de Nariño

Proyecto formulado en el contexto del convenio interinstitucional suscrito entre Artesanías de Colombia y la Gobernación del departamento de Nariño

Hilando Redes Humanas de Vida

Propuesta y planos de exhibidor de productos

Operador:
FUNDACIÓN EMSSANAR

Herney Villota

asesor

Gobernación de Nariño
Laboratorio Artesanías De Colombia –Nariño
Pasto, 2014

Arbol Propuesta

Exhibidor para productos artesanales

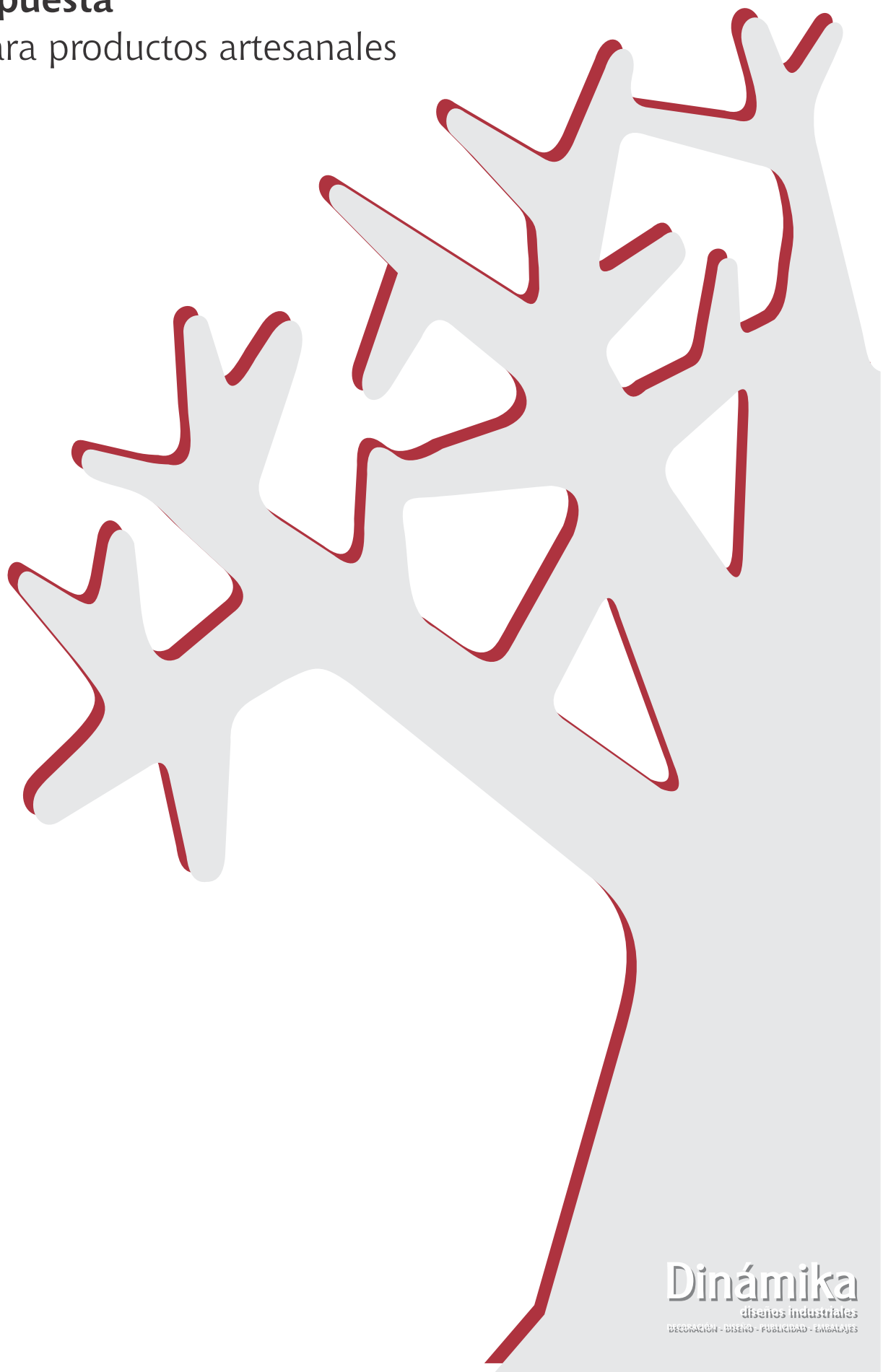

Exhibidor para productos artesanales

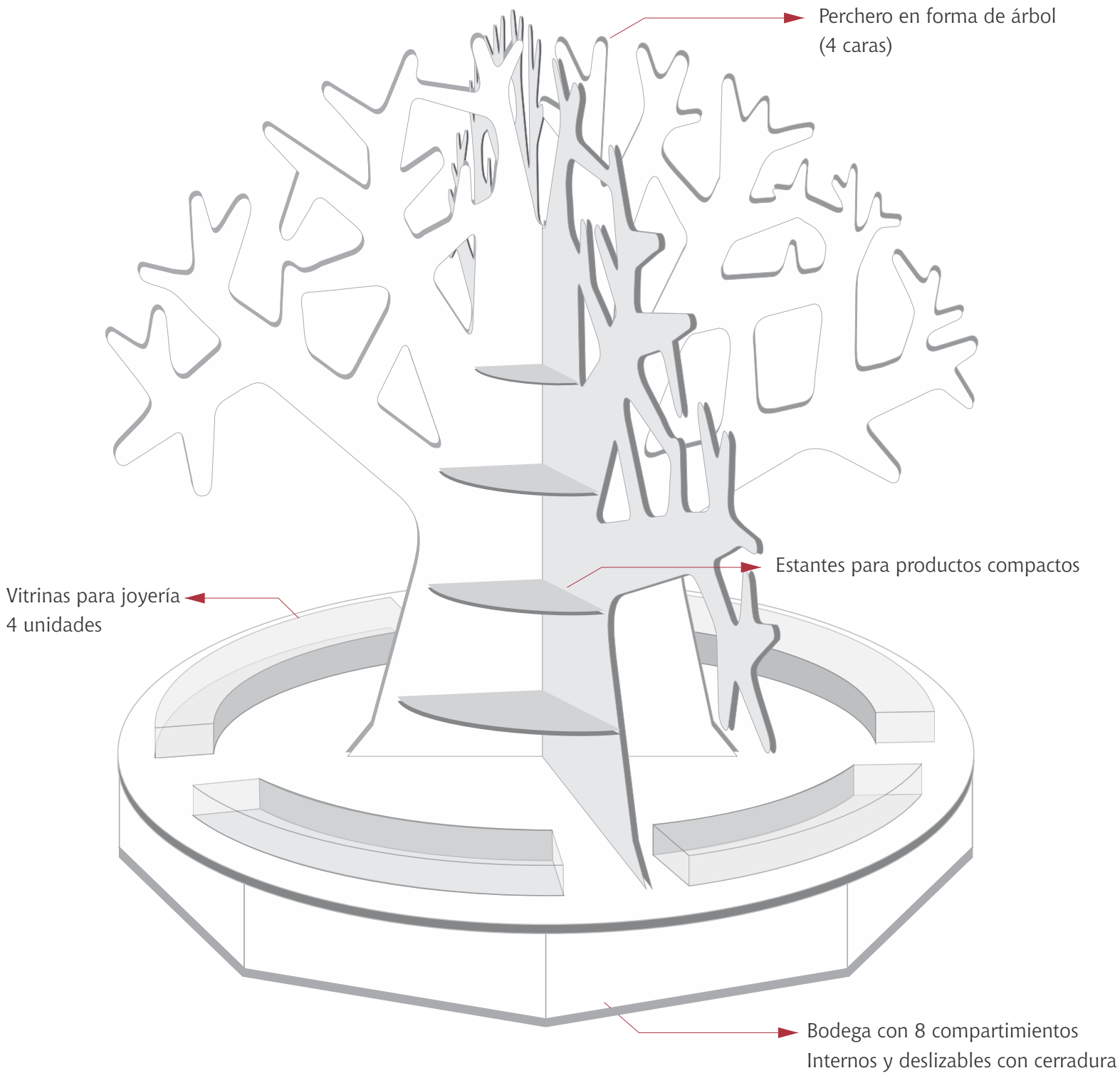

Forro para protección exhibidor

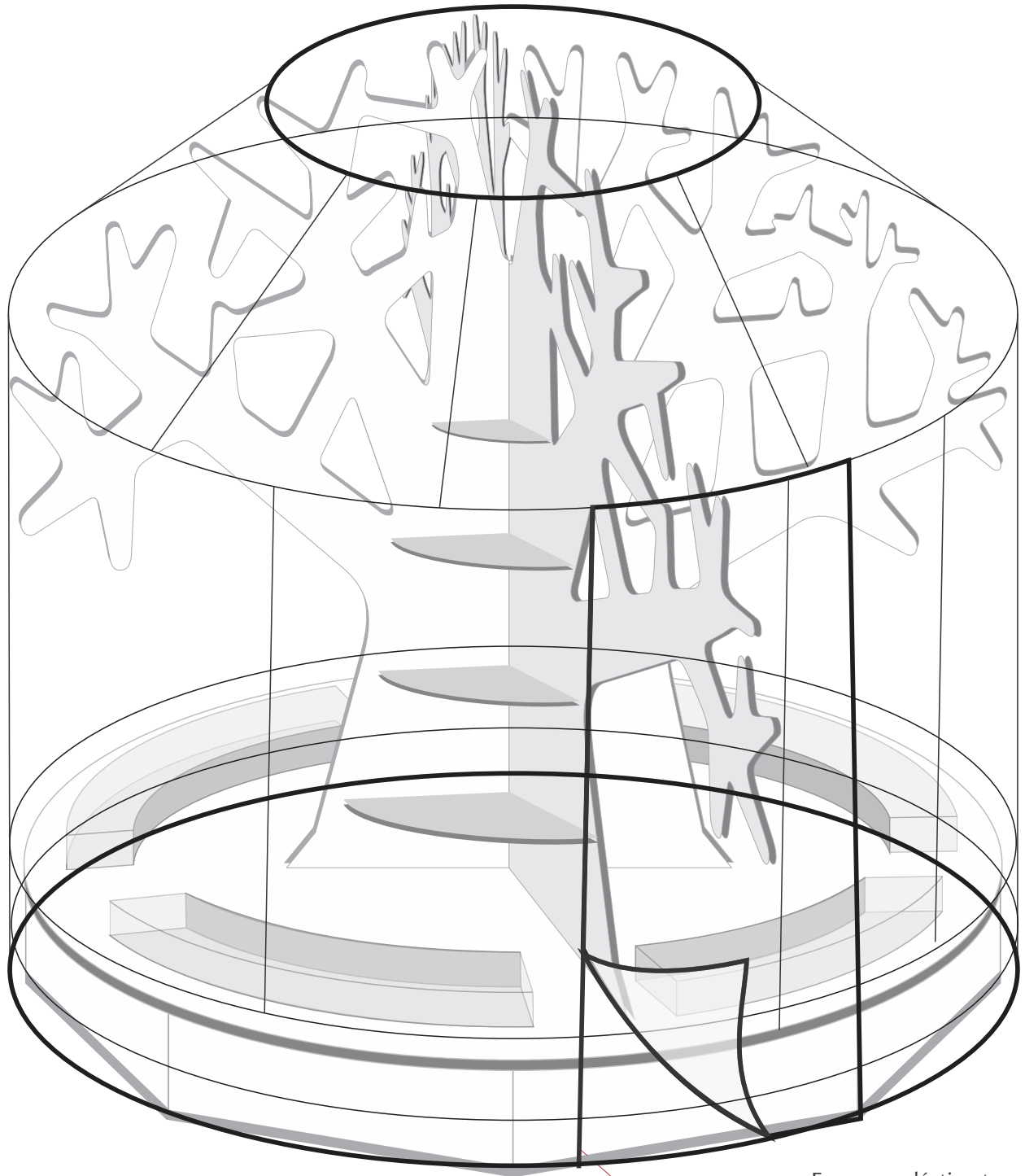

Forro en plástico transparente
cierre lateral.

Exhibidor para productos artesanales- parte grafica

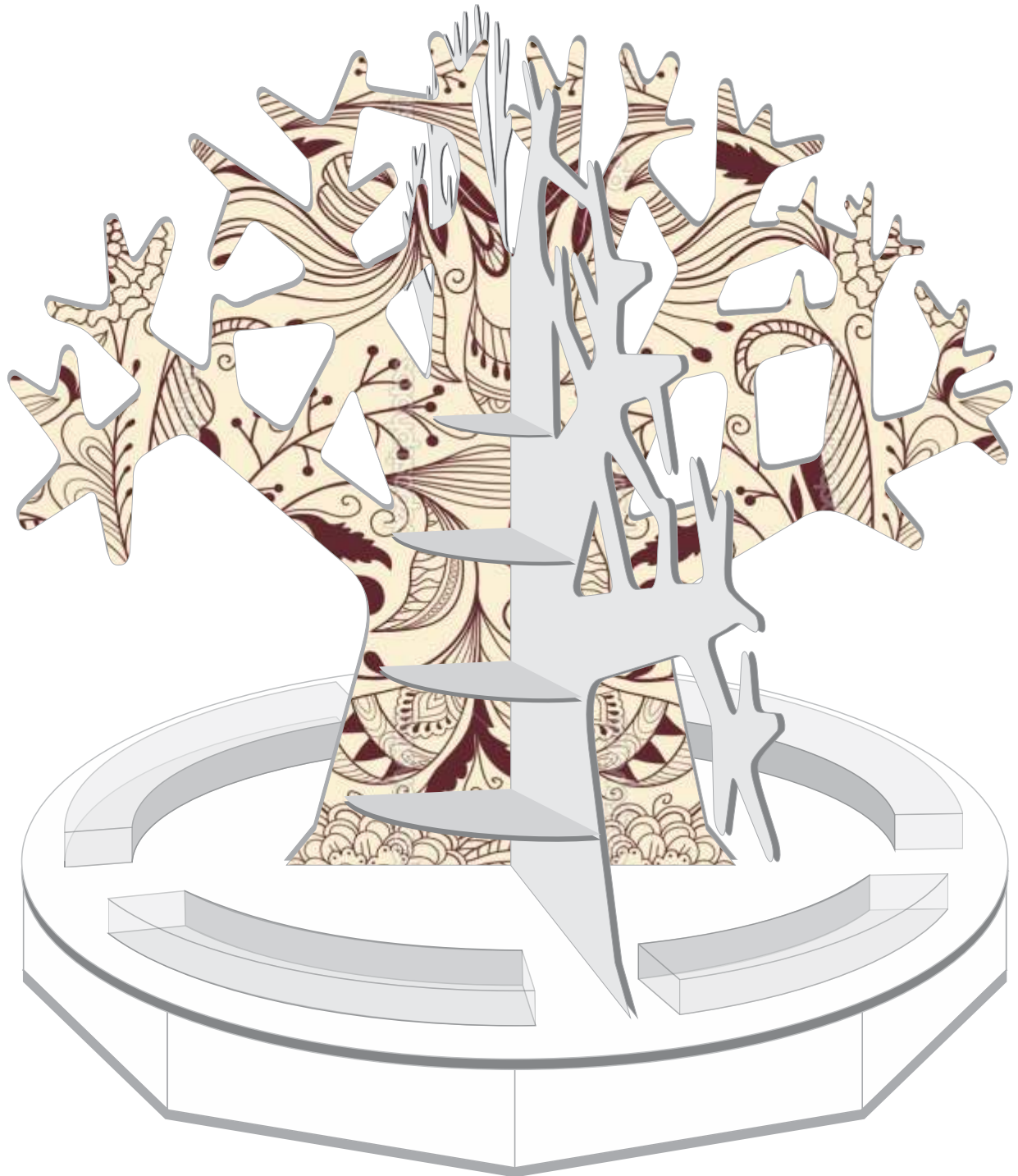

Parte grafica



Apliques en madera parte superior



Vista Frontal Arbol

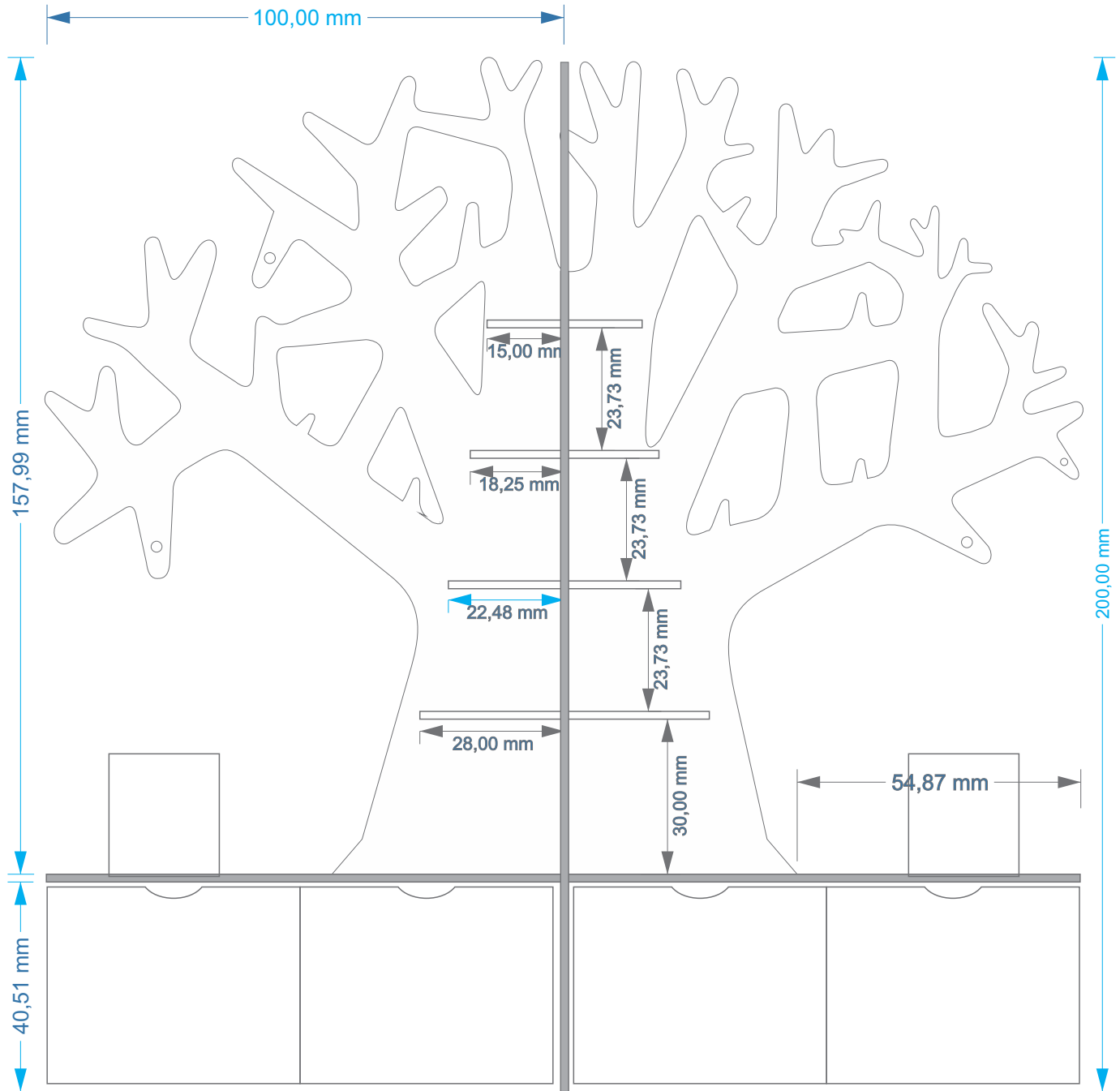

Vista de Planta Árbol



Cajones internos bodega parte inferior (8 und.)

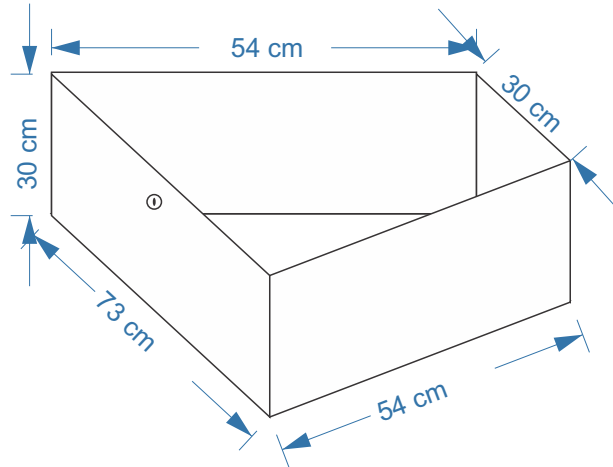

DISTRIBUCIÓN - Cajones internos bodega parte inferior

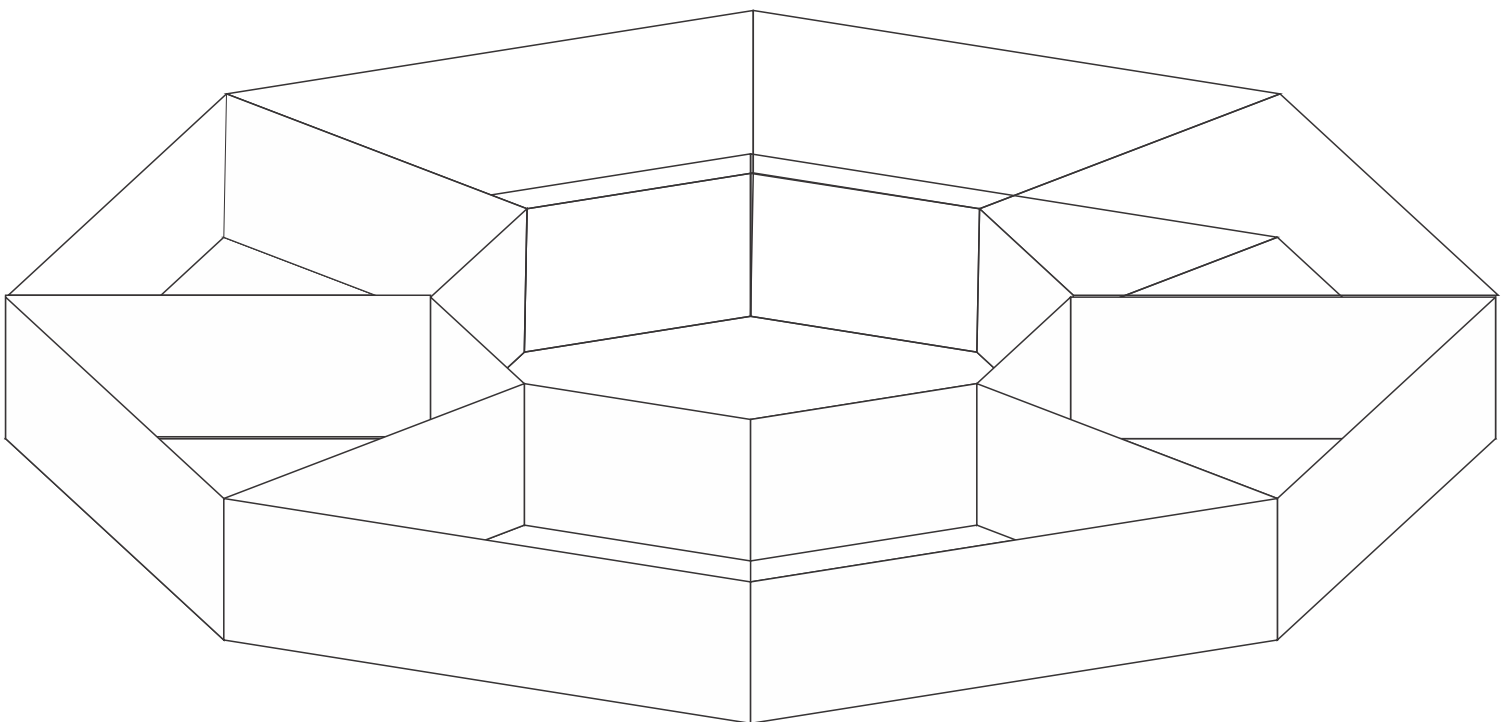

Vitrinas para joyería(4 und.)

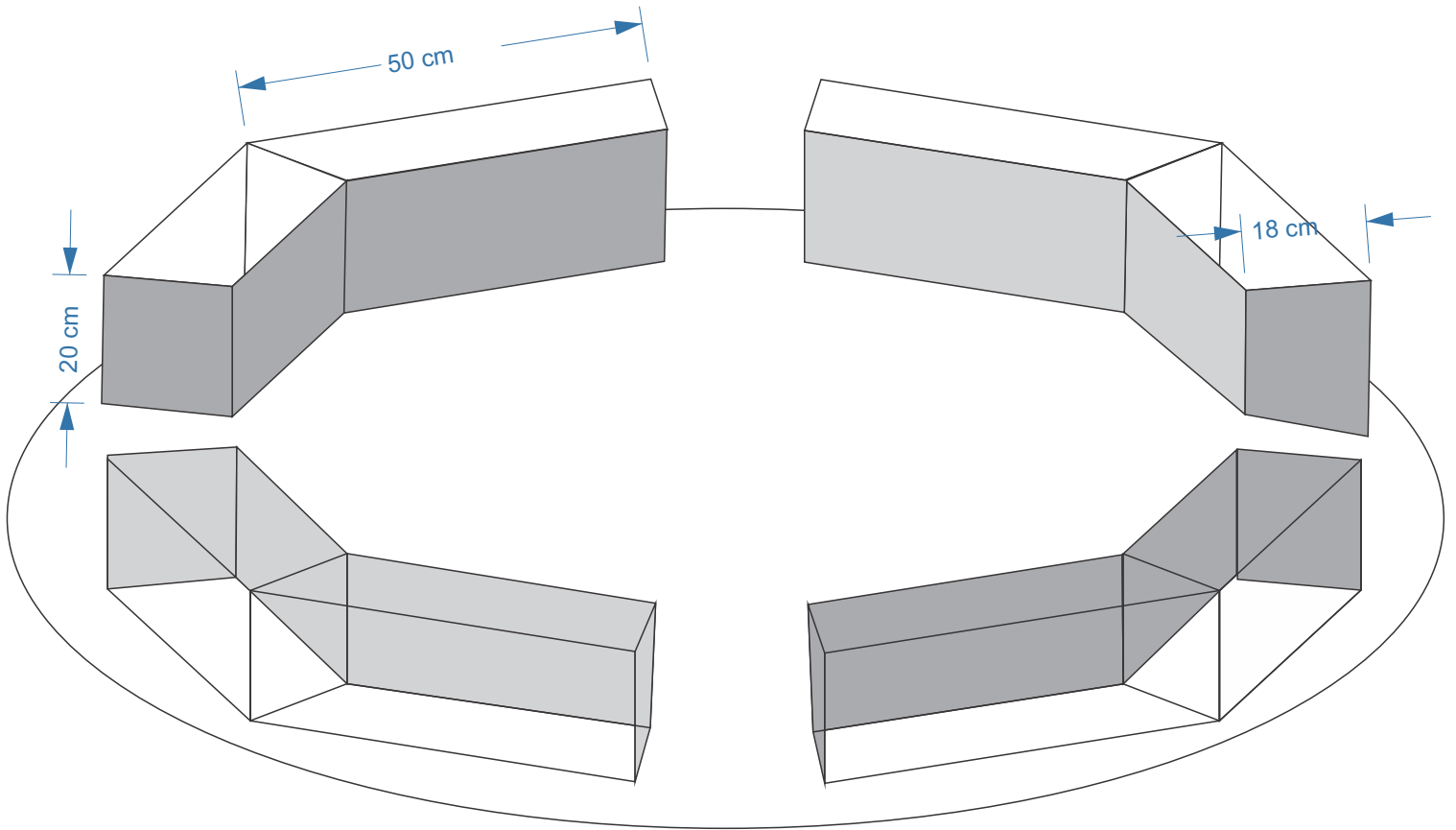

Cara superior y frontal en vidrio, paredes en madera. con puerta lateral y chapa con llave.





+57- 318-737-2948



ney.villota@gmail.com



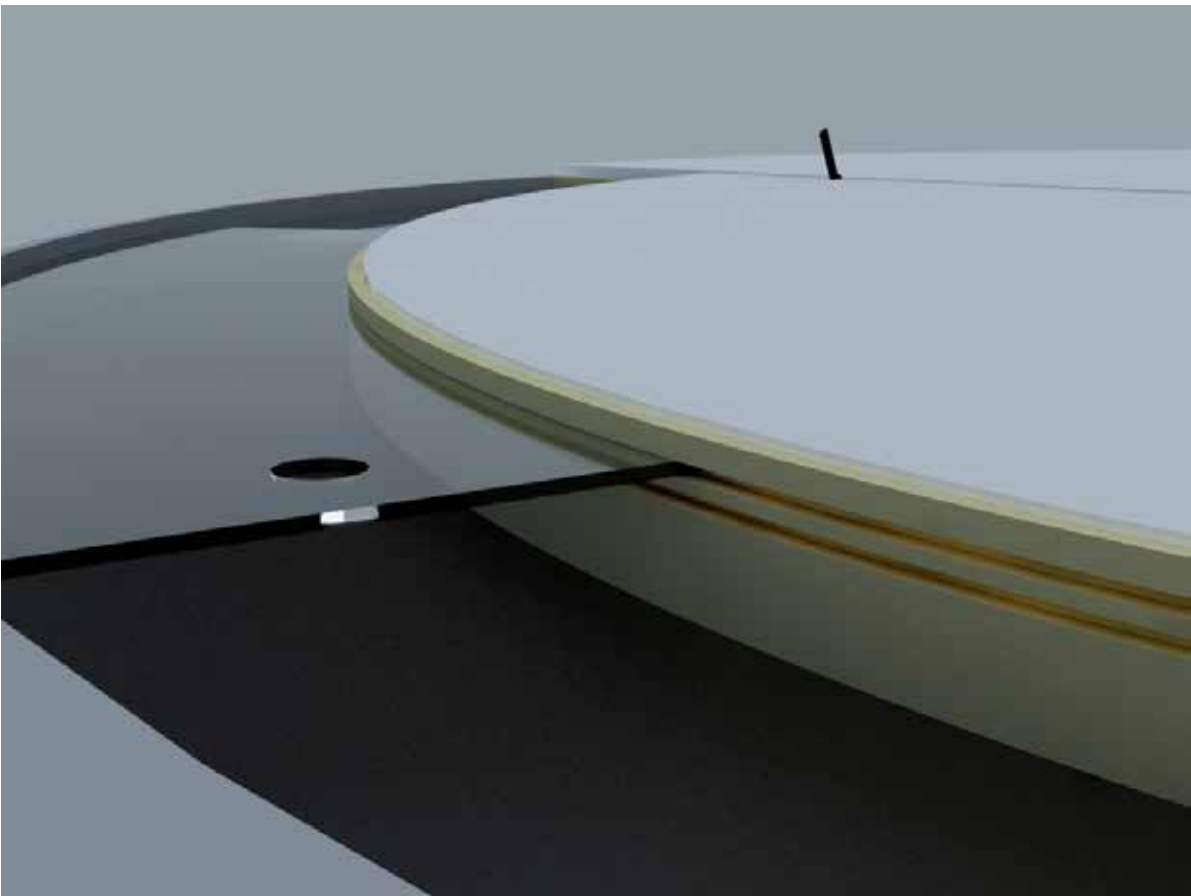
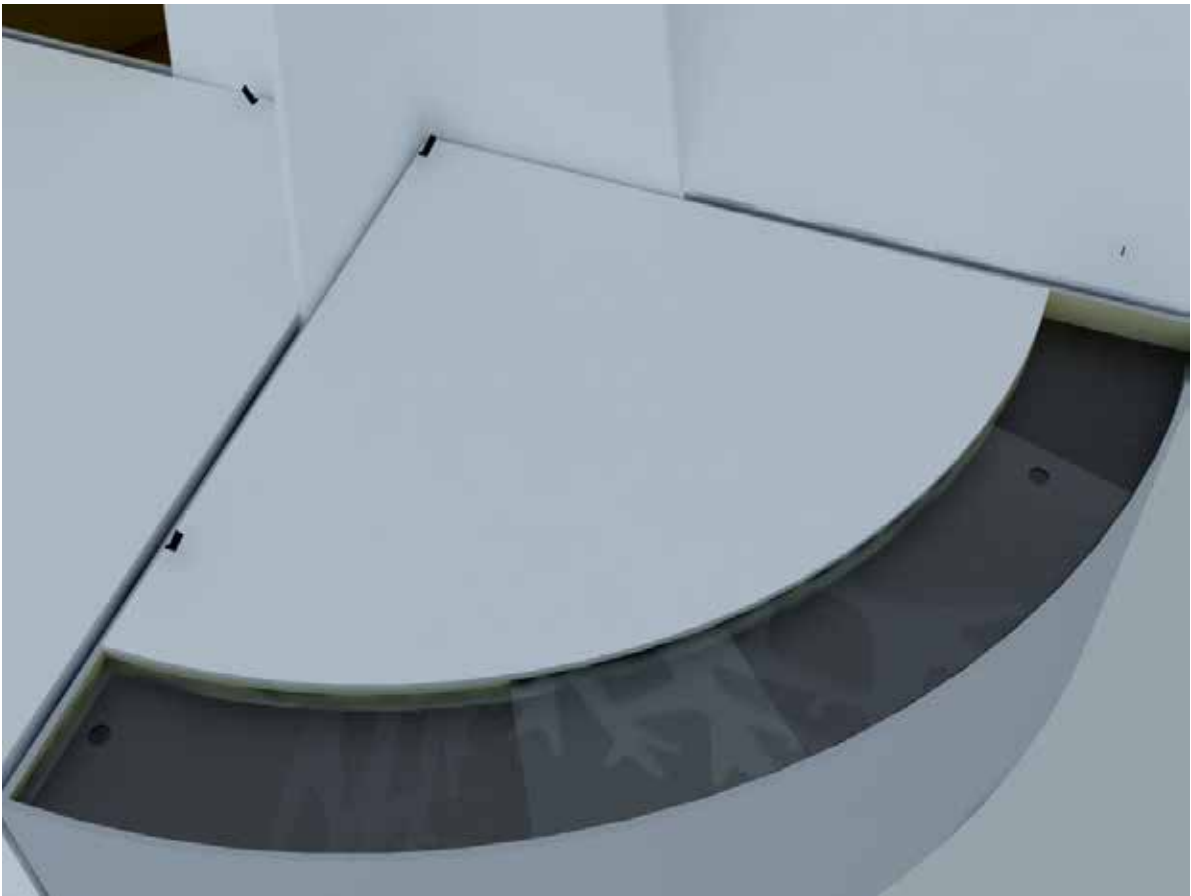



**BRAZOS PARA PUERTAS
PARA BODEGAS**

**SISTEMA DE VITRINAS
PARA JOYERIA**

**SISTEMA DE ILUMINACIÓN
LED**



**RODACHINES
CAPACIDAD 30 KIg**

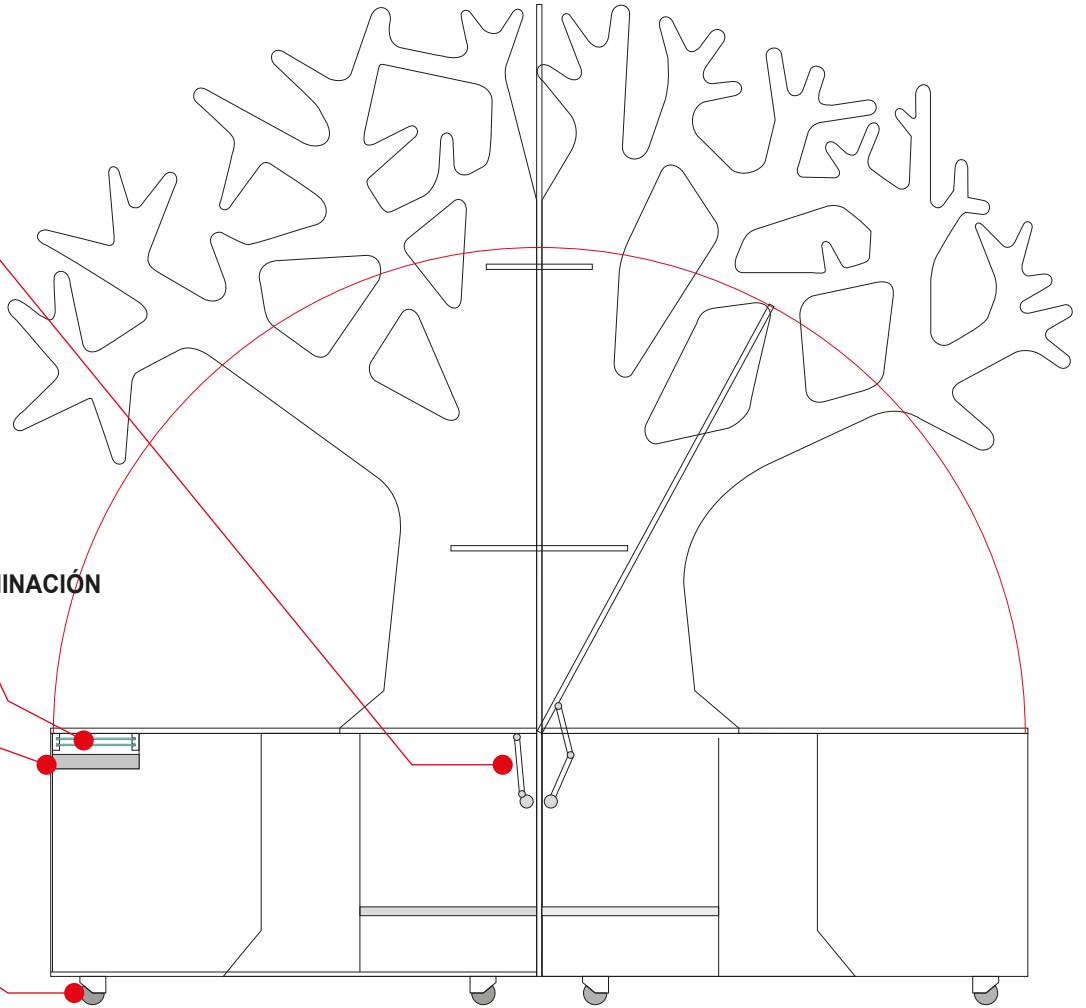

+57- 318-737-2948



ney.villota@gmail.com

220 cm

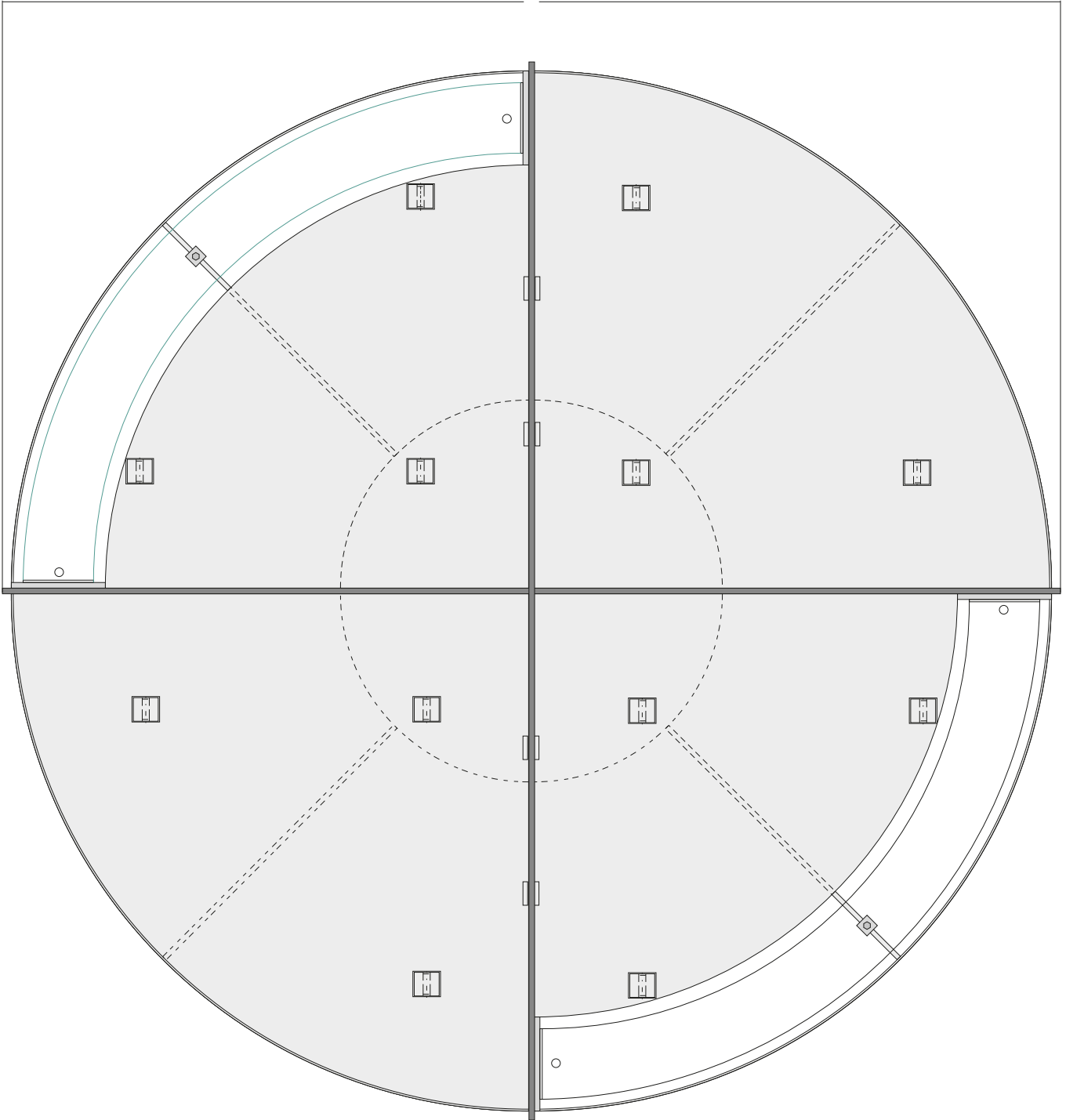

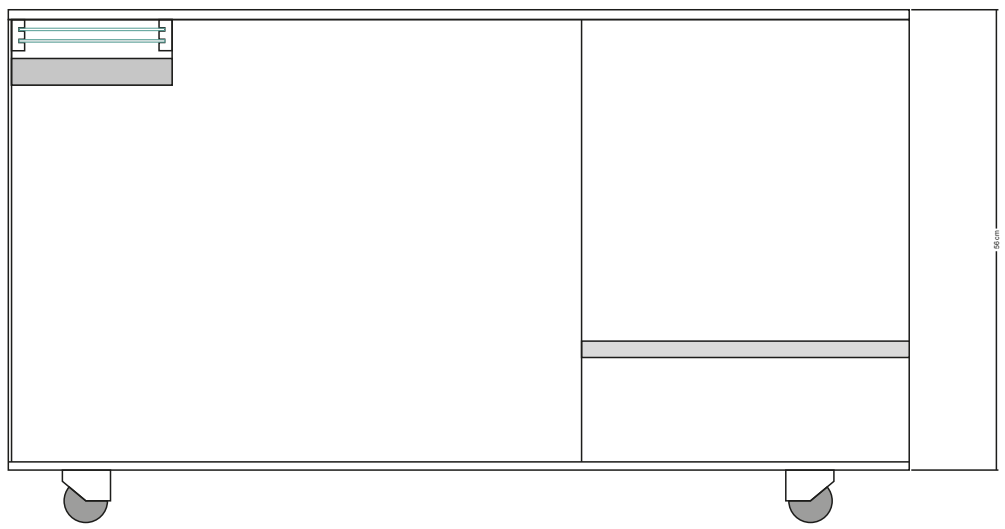
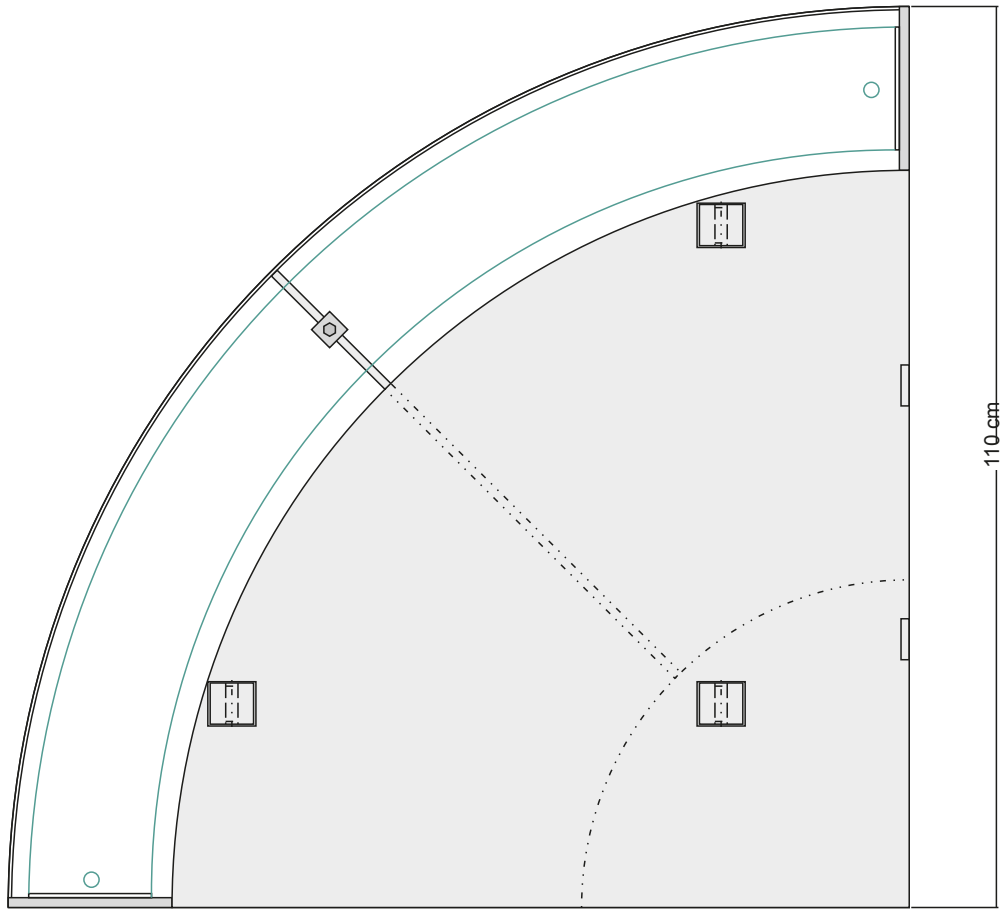

+57- 318-737-2948



ney.villota@gmail.com

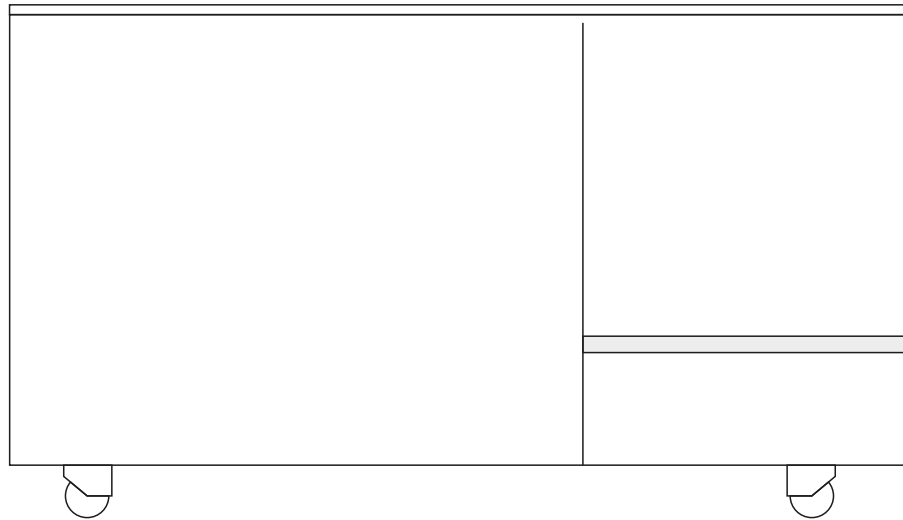
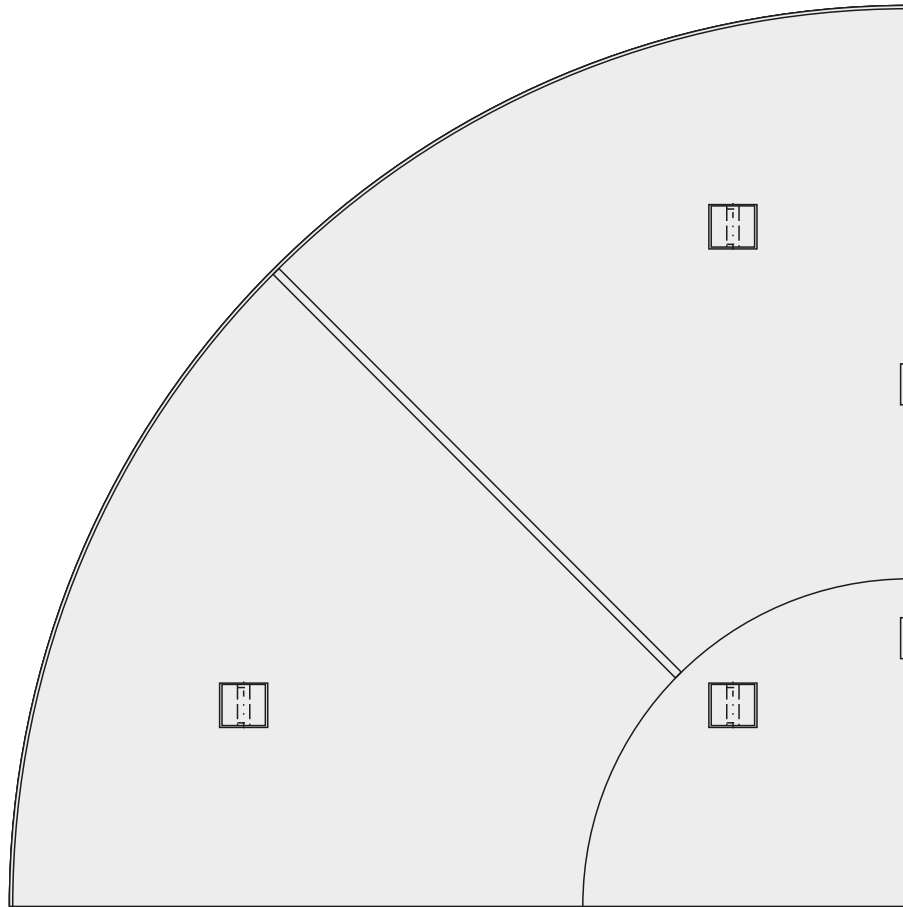

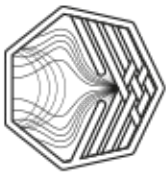

ILLARIY

PROYECTO HILANDO REDES HUMANAS DE VIDA

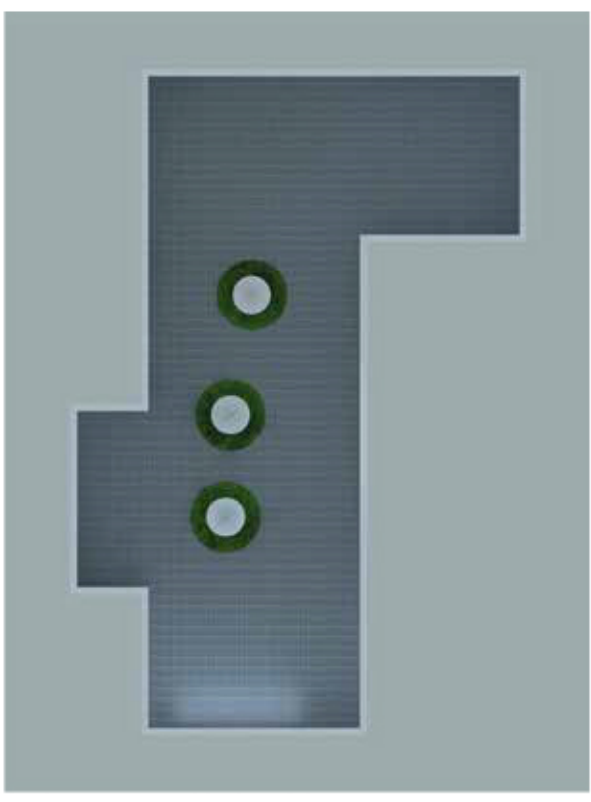

- LOS MODULOS ESTARAN UBICADOS EN EL HALL DE LA PUERTA NUMERO 3 DEL CENTRO COMERCIAL UNICENTRO.

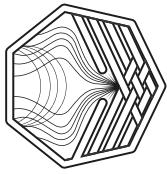

ILLARIY

PROYECTO HILANDO REDES HUMANAS DE VIDA

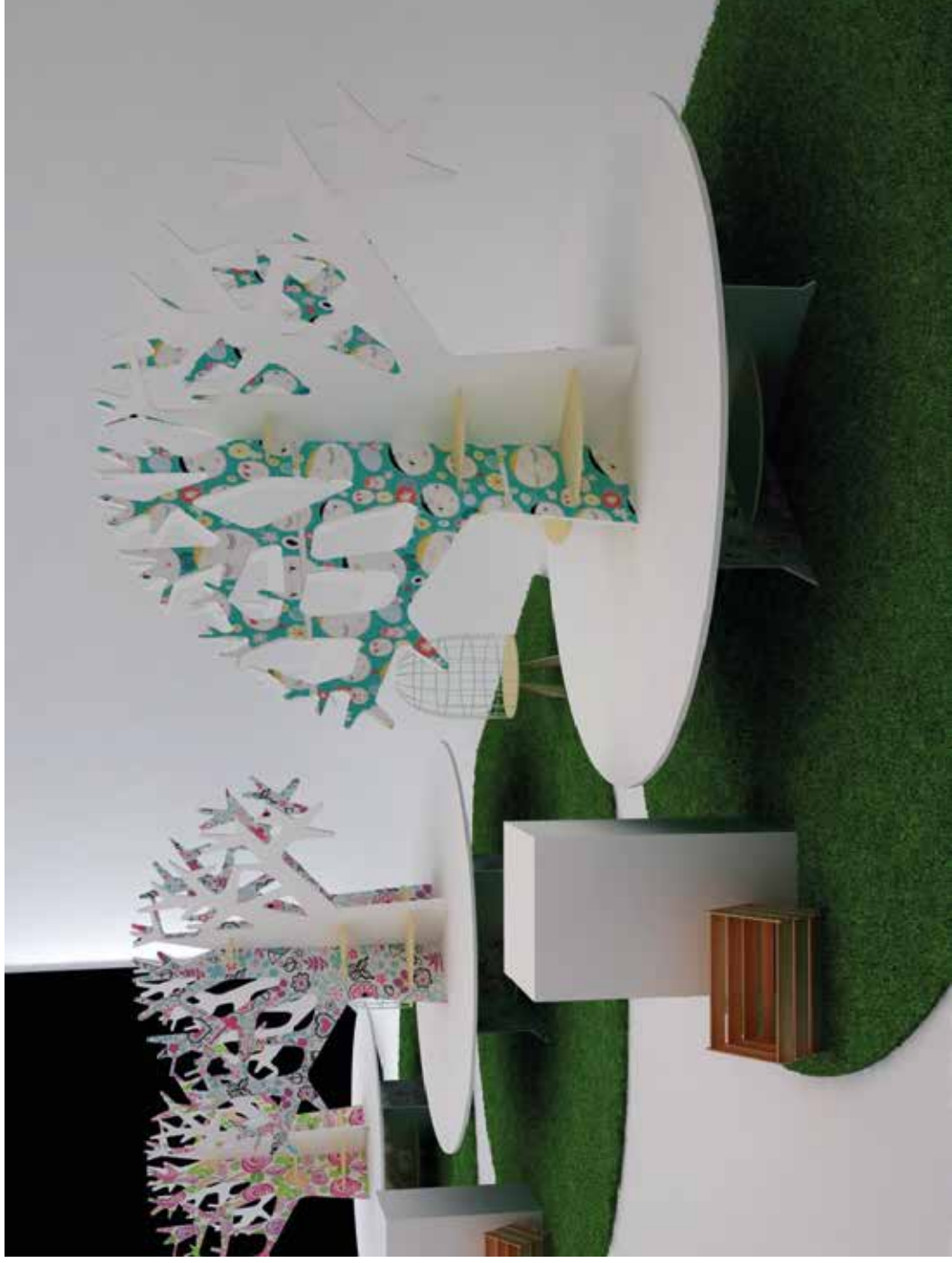

● EL STAND CONSTA DE 3 MODULOS, LOS CUALES TIENEN LAS SIGUIENTES CARACTERISTICAS:

DIMENSIÓN DE 4 M

ALTURA DE 220 x 240

**MATERIALES : CESPED SINTETICO Y
MDF DE 12mm**

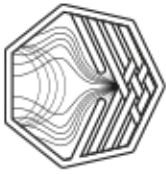

ILLARIY

PROYECTO HILANDO REDES HUMANAS DE VIDA

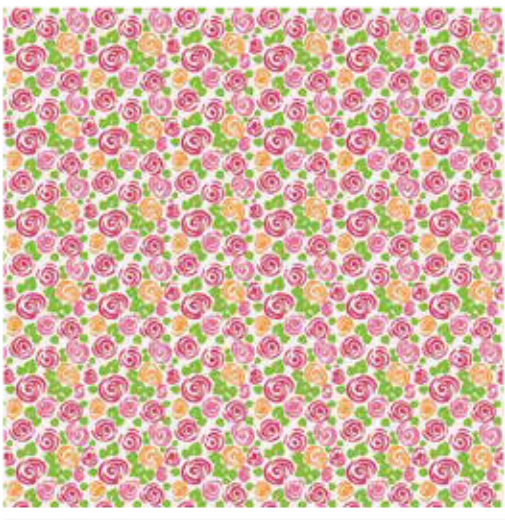

● TEXTURA IMPRESA EN EL MODULO

1

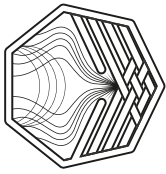

ILLARIY

PROYECTO HILANDO REDES HUMANAS DE VIDA



● TEXTURA IMPRESA EN EL MODULO
2

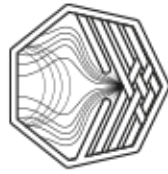

ILLARIY

PROYECTO HILANDO REDES HUMANAS DE VIDA



● TEXTURA IMPRESA EN EL MODULO

3

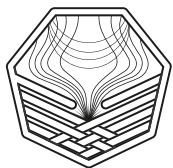

ILLARIY

PROYECTO HILANDO REDES HUMANAS DE VIDA

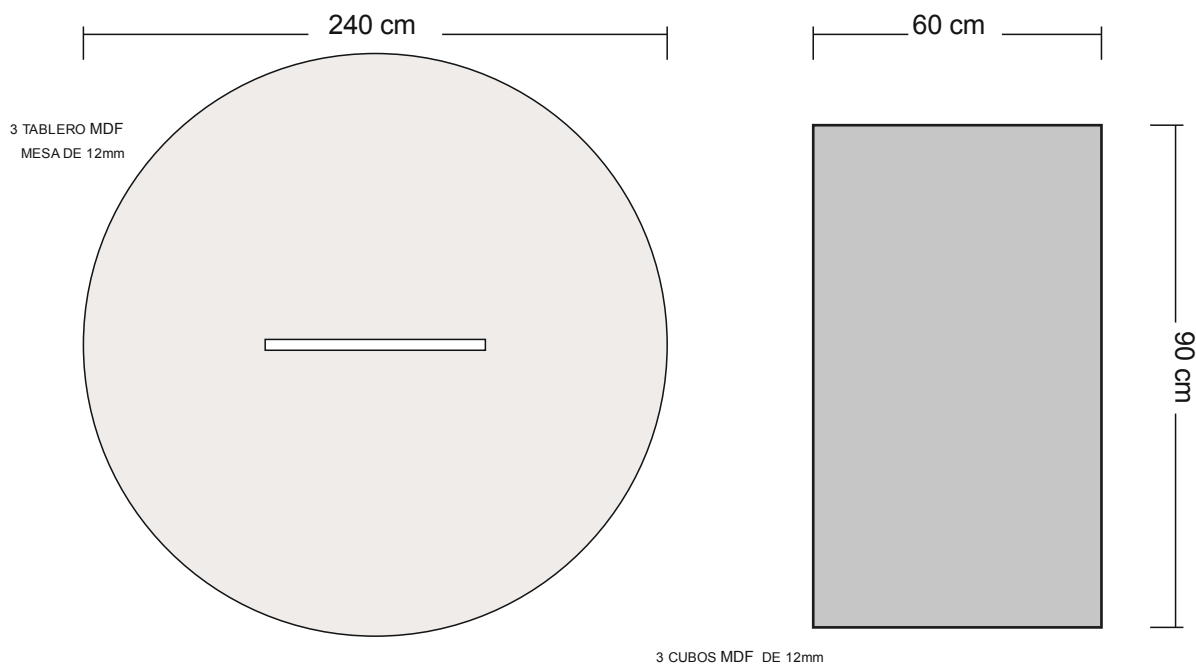
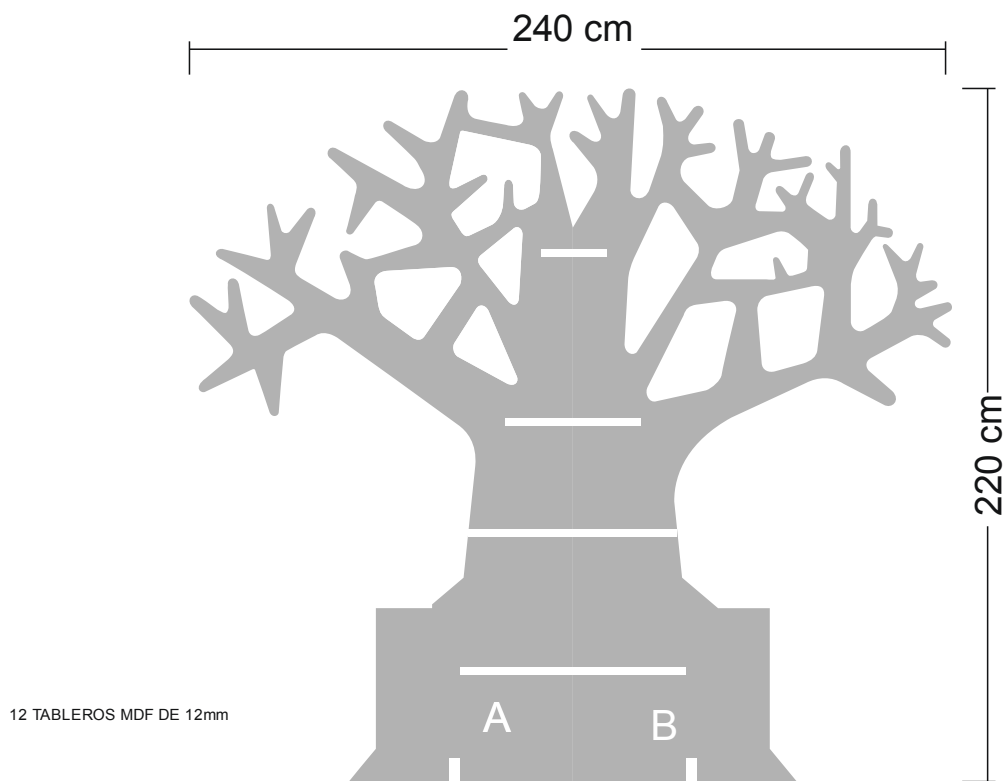

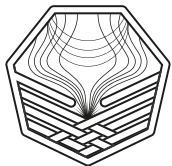

ILLARIY

PROYECTO HILANDO REDES HUMANAS DE VIDA

400 cm

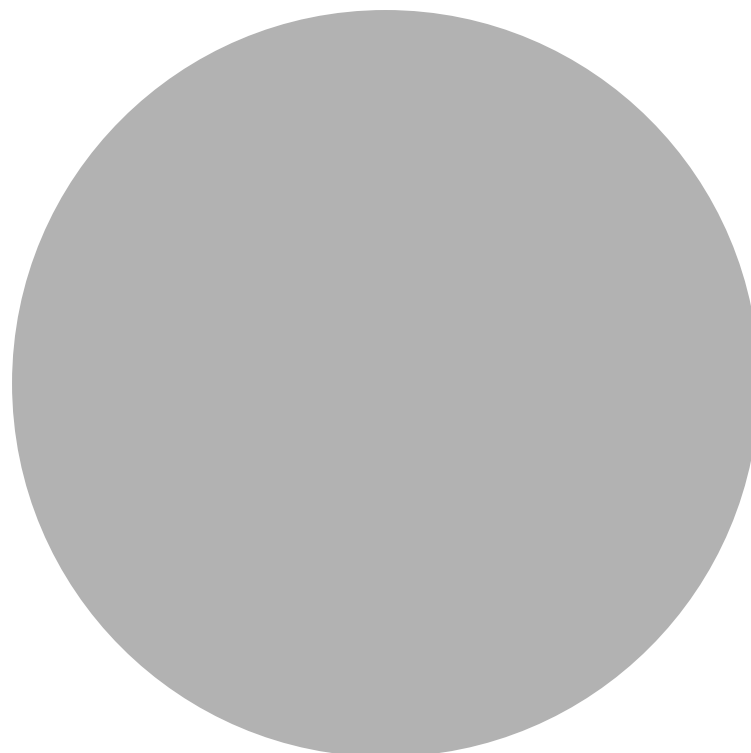

CESPED SINTETICO



8 GUACALES DE MADERA RUSTICA

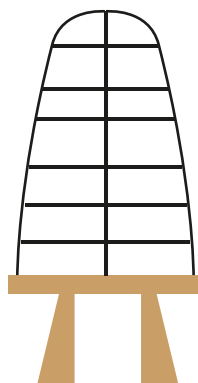

2 JAULAS METALICAS CON
BASE EN MDF DE 12 mm 80cm x 25 r