

Ministerio de Comercio, Industria y Turismo
artesanías de colombia s.a.

[Bocetos renderizados de desarrollo de productos de innovación
para artesanos de los municipios de Manizales, Marmato y
Pensilvania , Caldas.]

[Propuestas de productos en joyería, moda, trabajos en madera y manualidades]

Marcela Jaramillo Moscoso
Asesora en diseño

Manizales, Octubre 2014

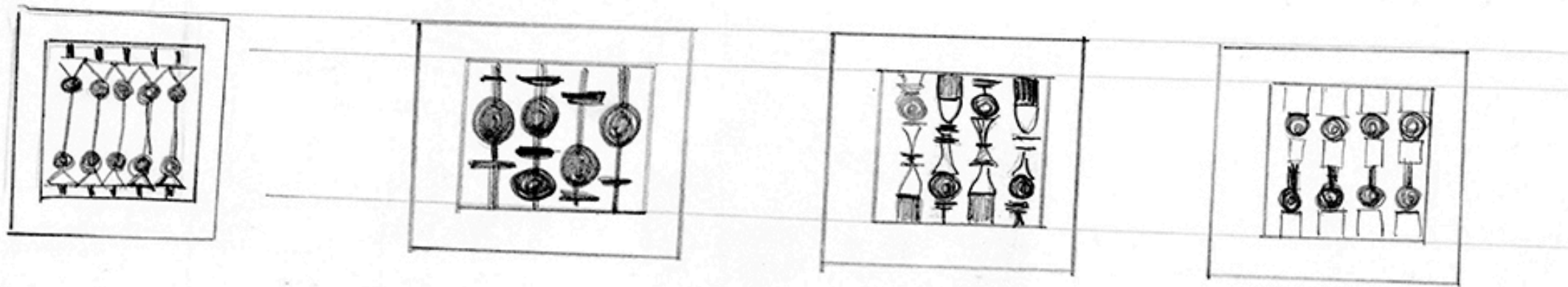
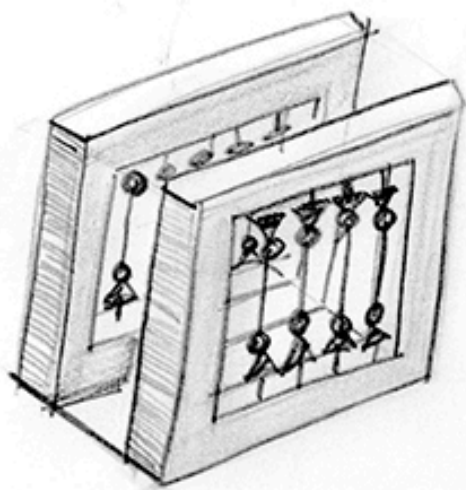

①

Balcones
 Chambres
Colindes

Genilletes

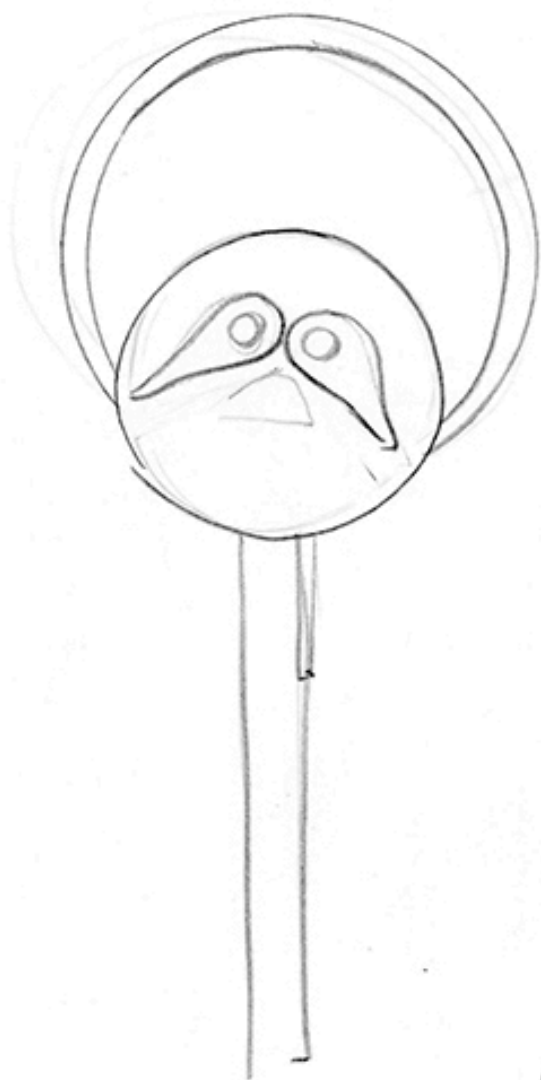
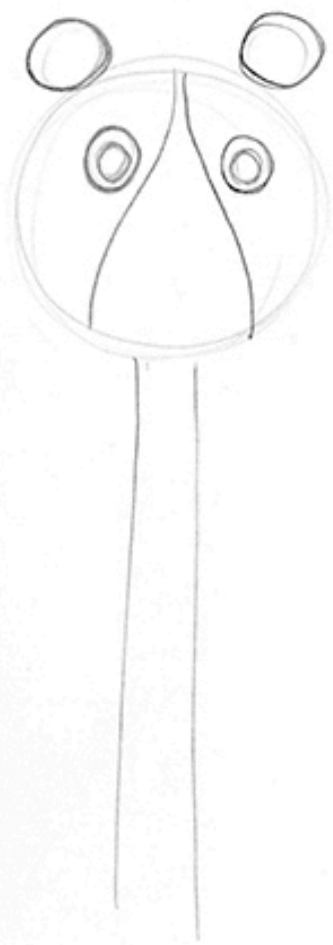
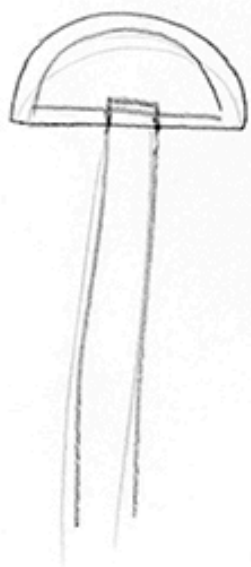
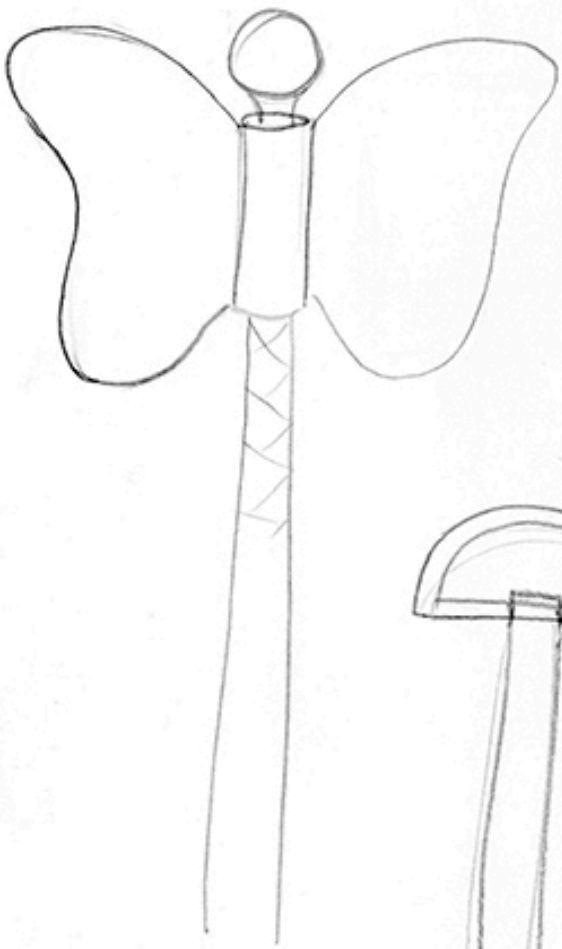

cuerdas automáticas

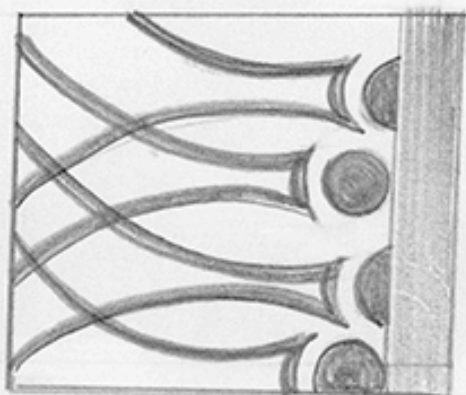
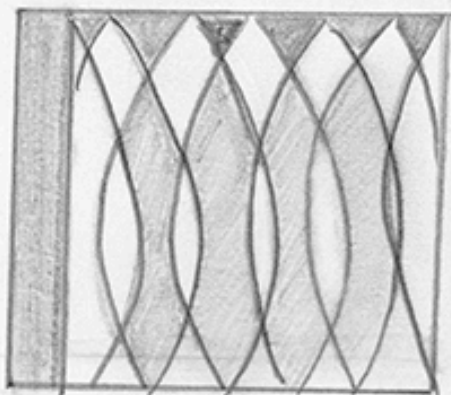
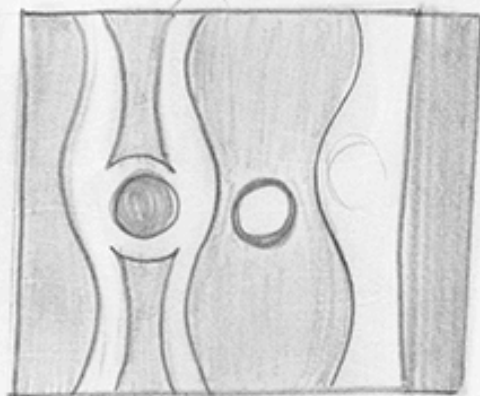
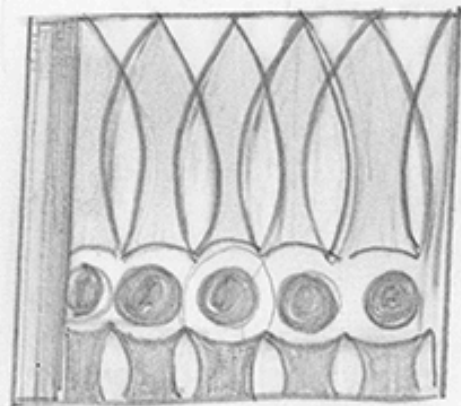

Rehman
El Kew

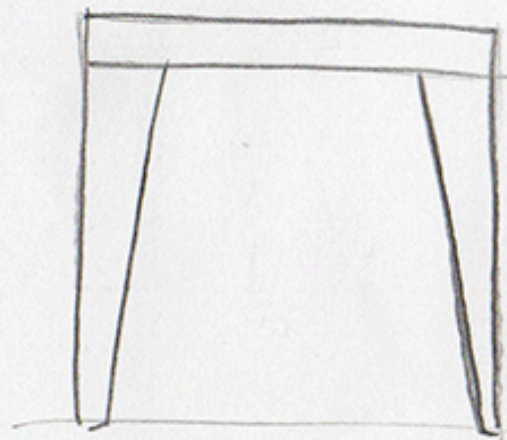
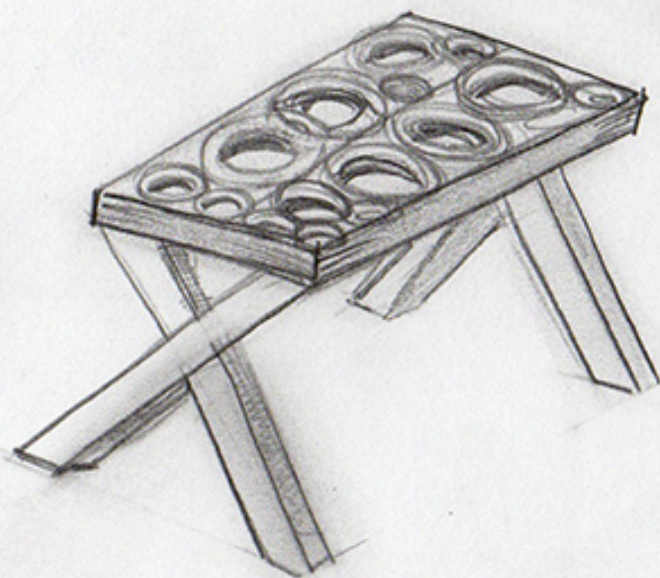
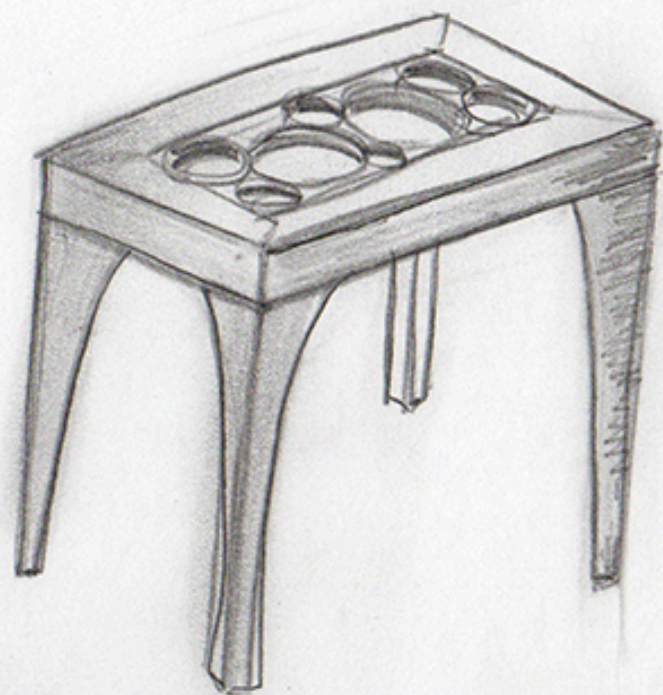
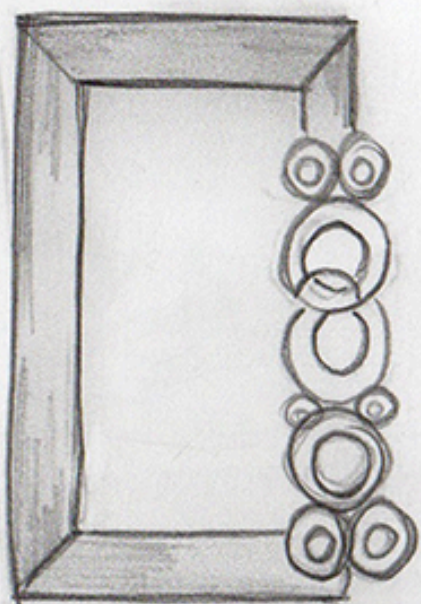

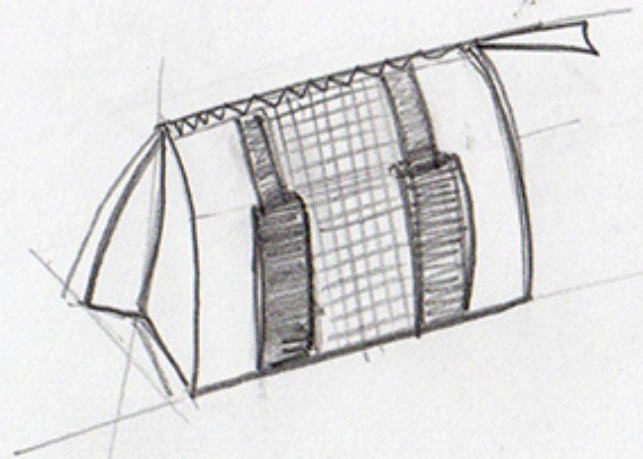
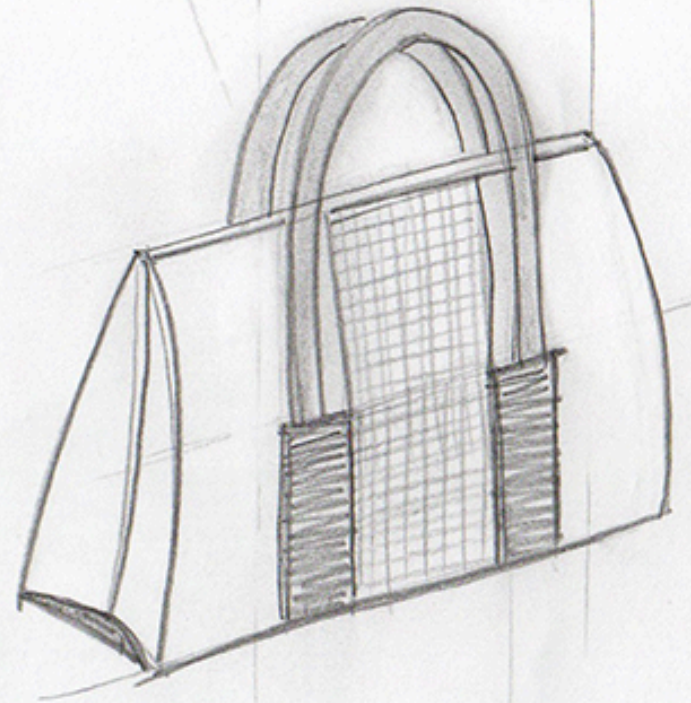
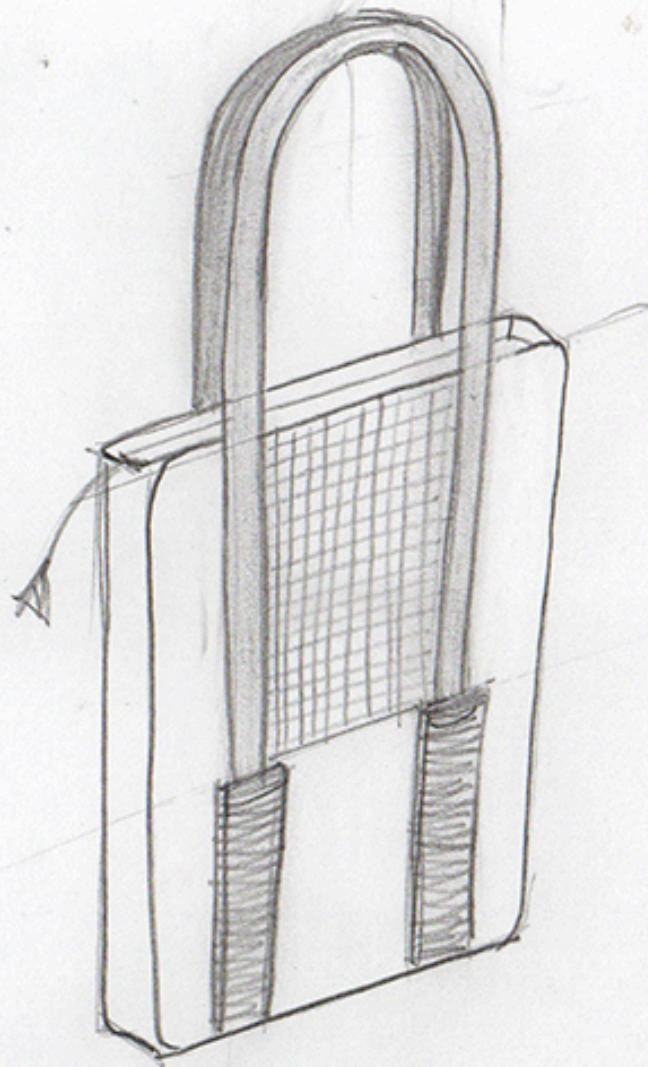

tejido
repujado

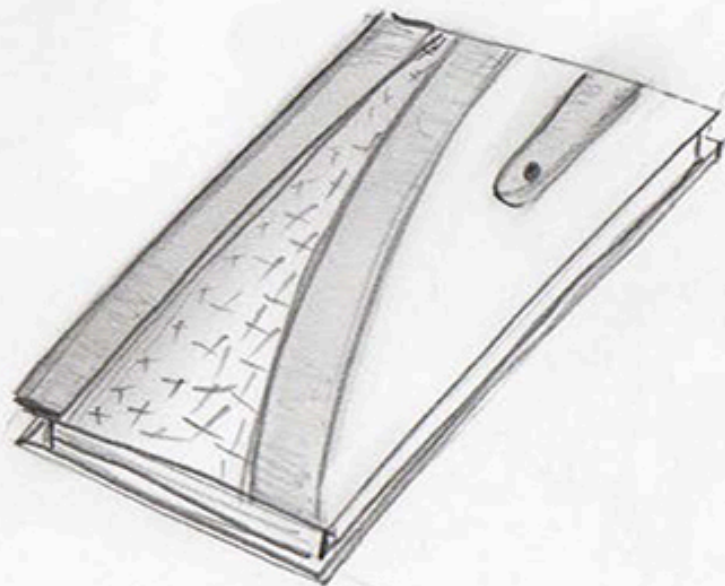
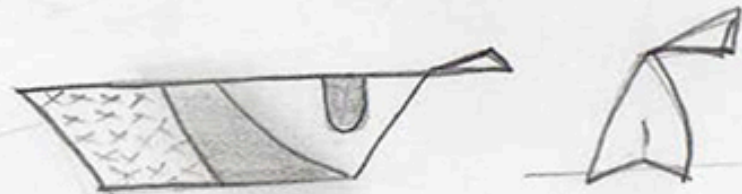
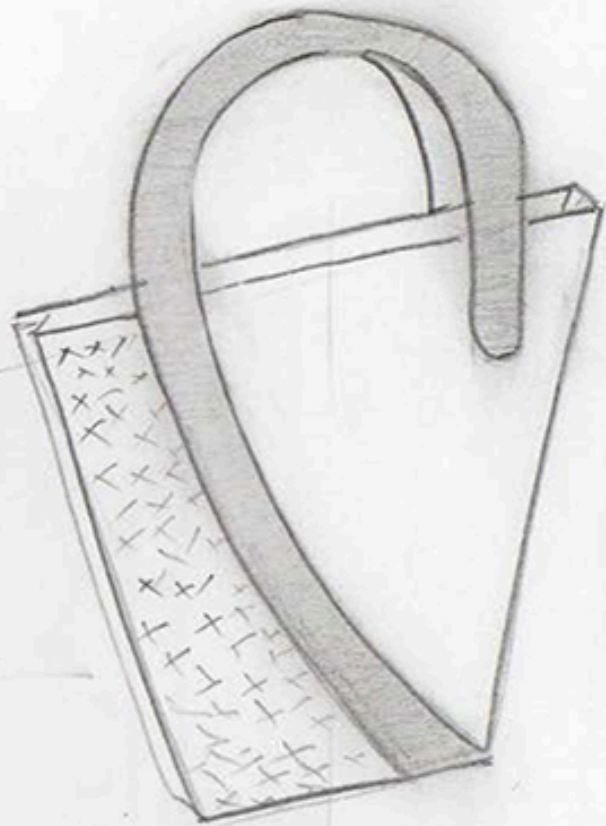

x →
Repujado
Cuero.

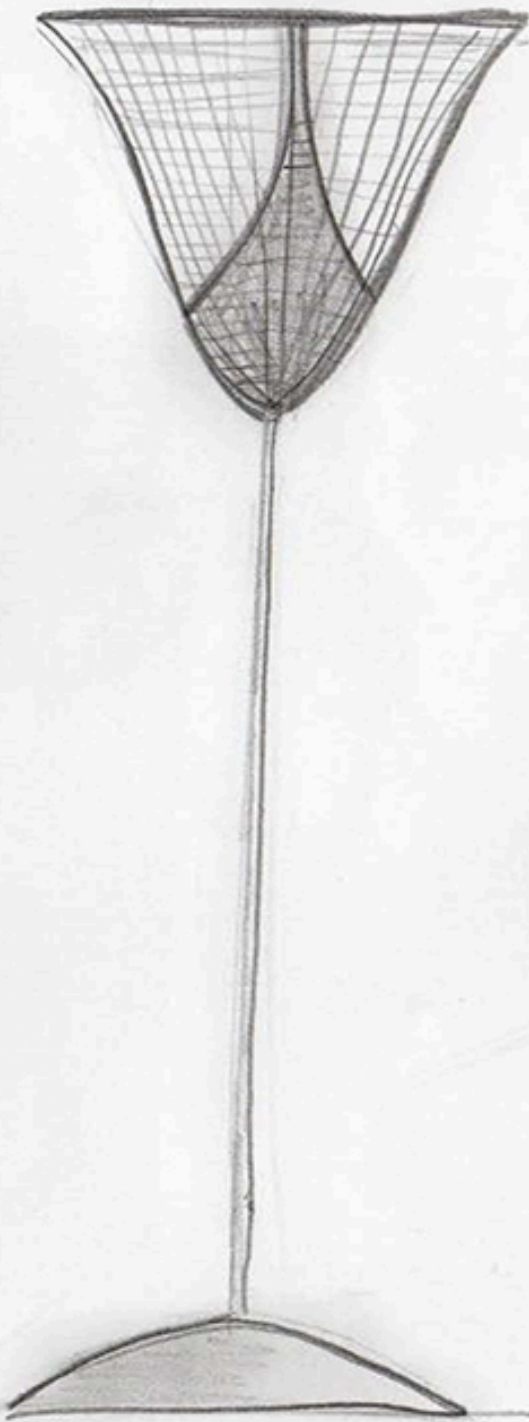
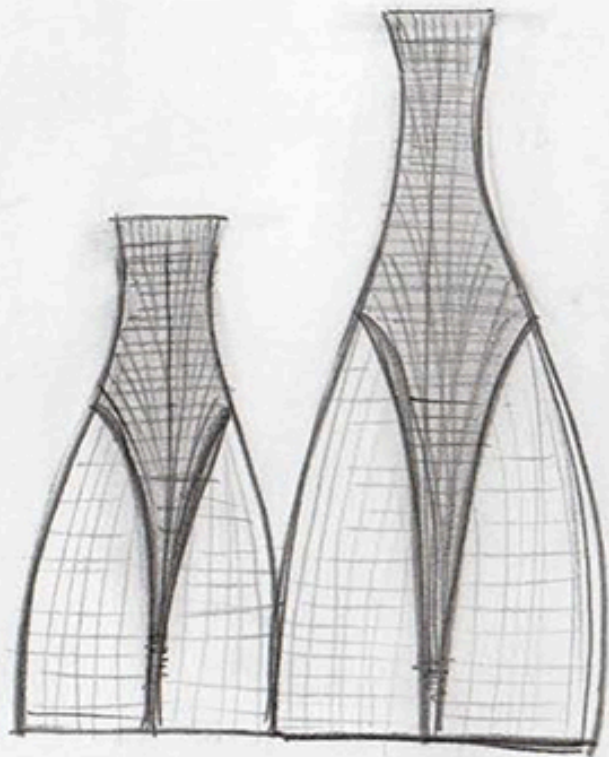
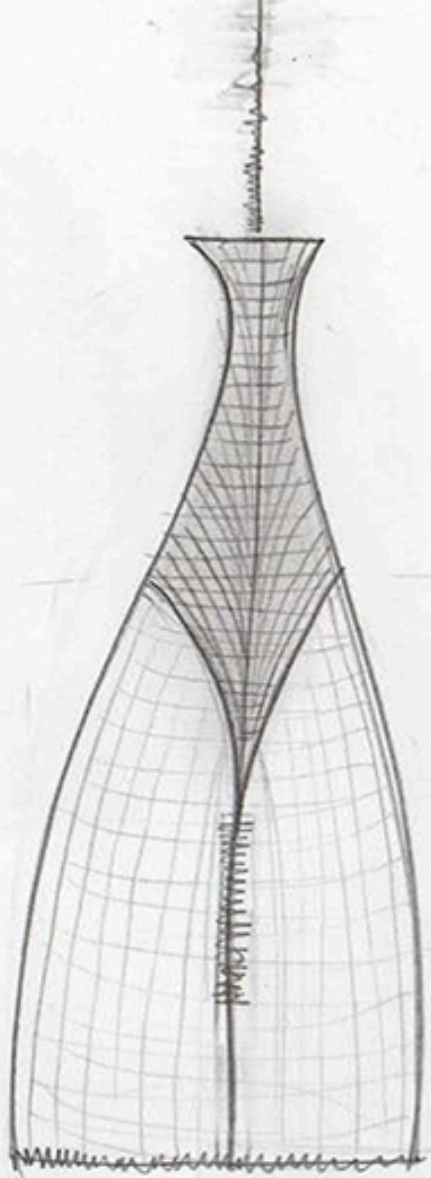

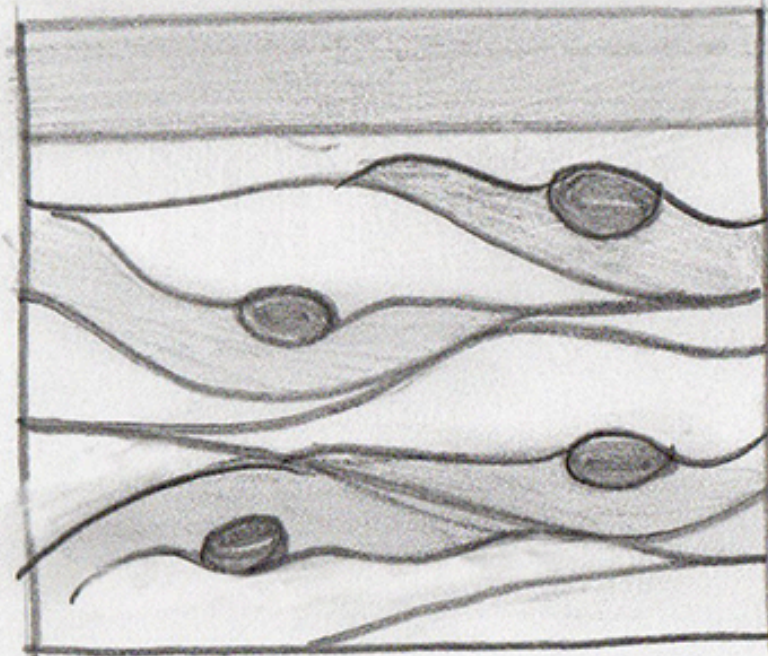
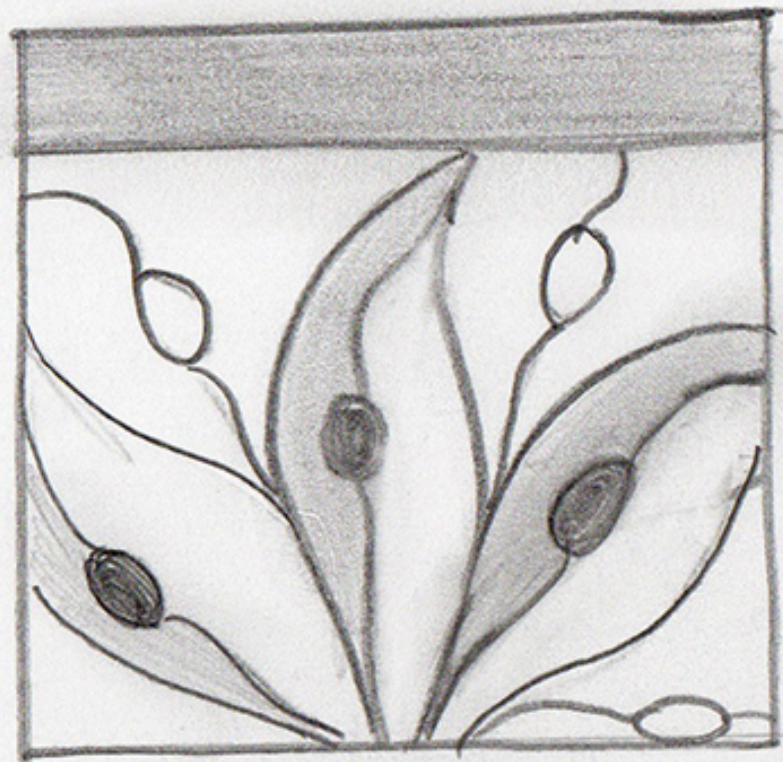
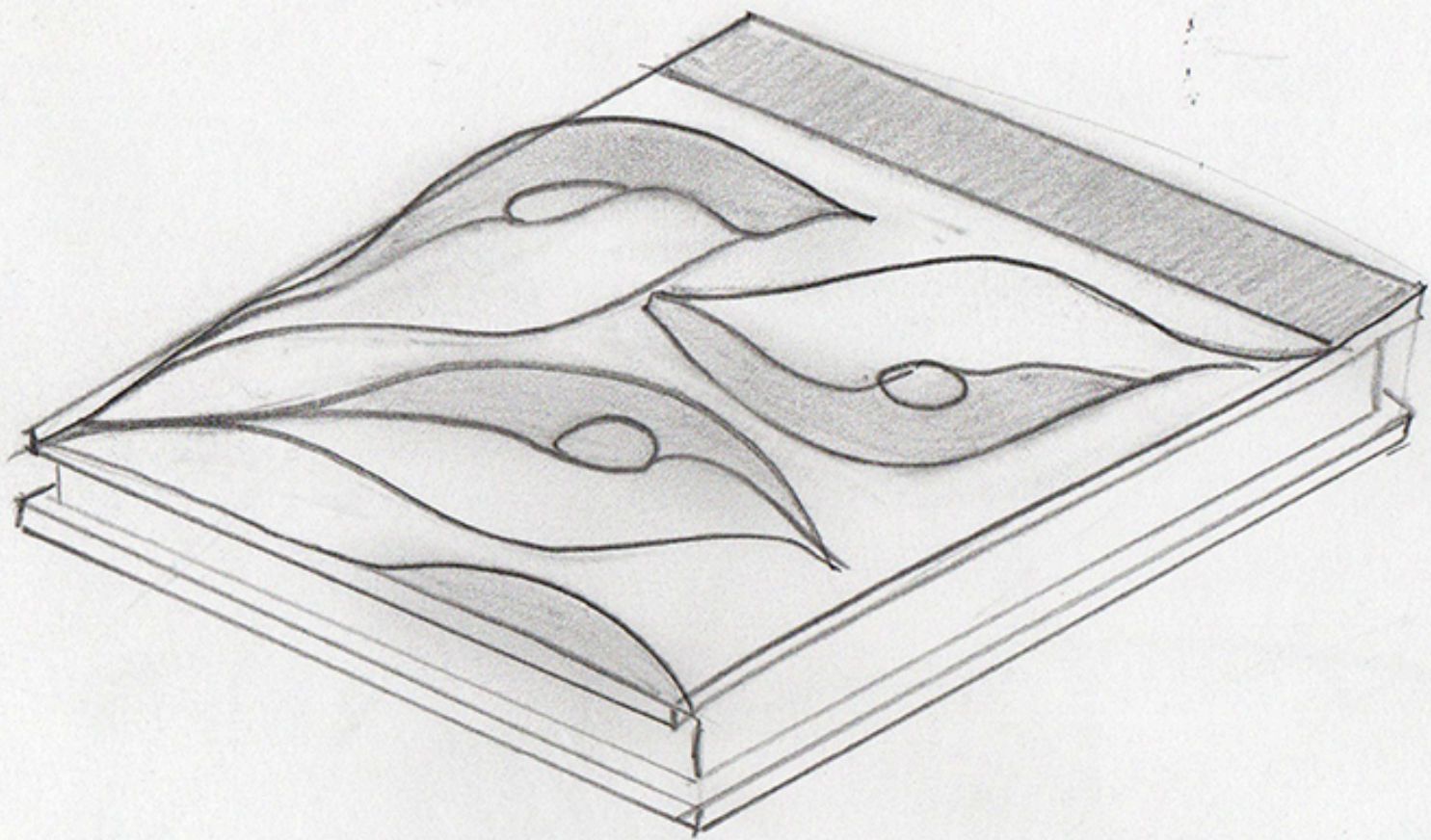

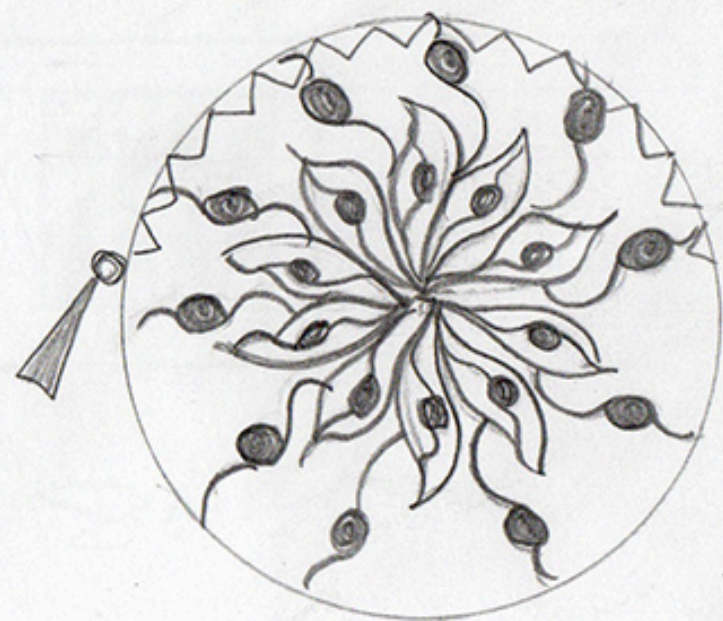

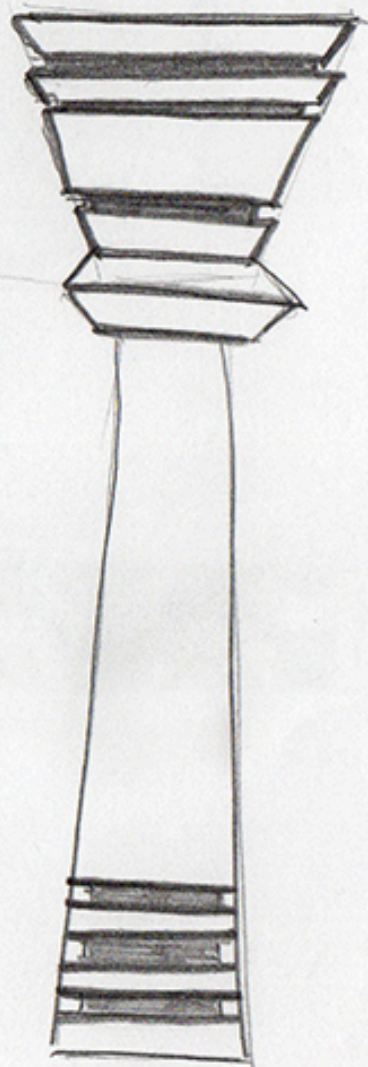
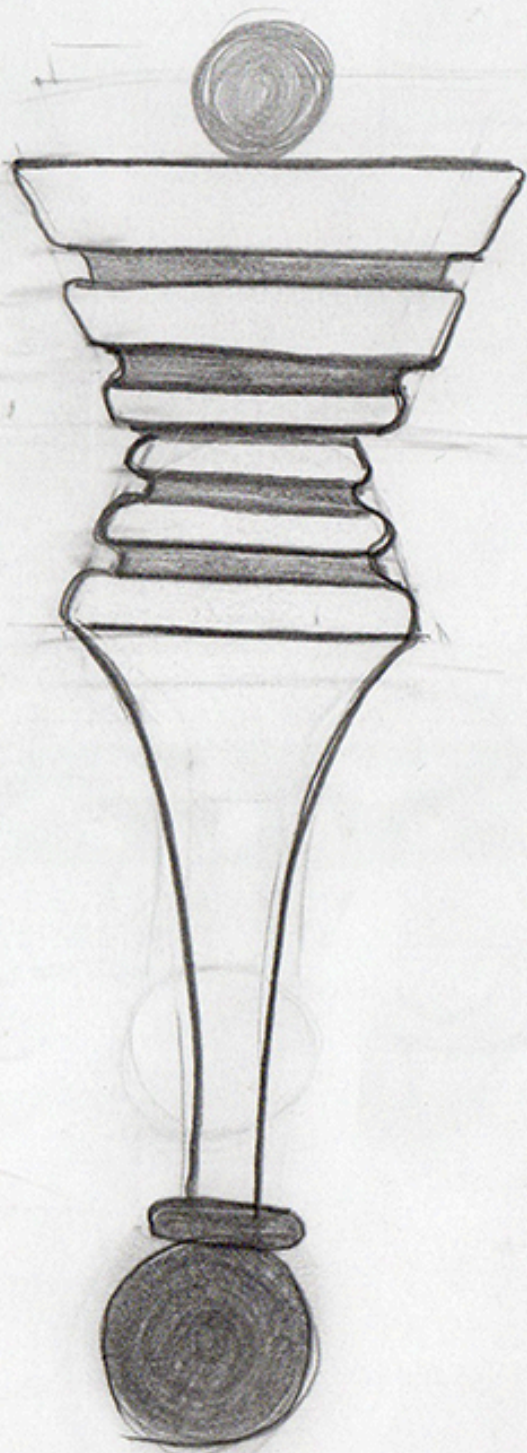
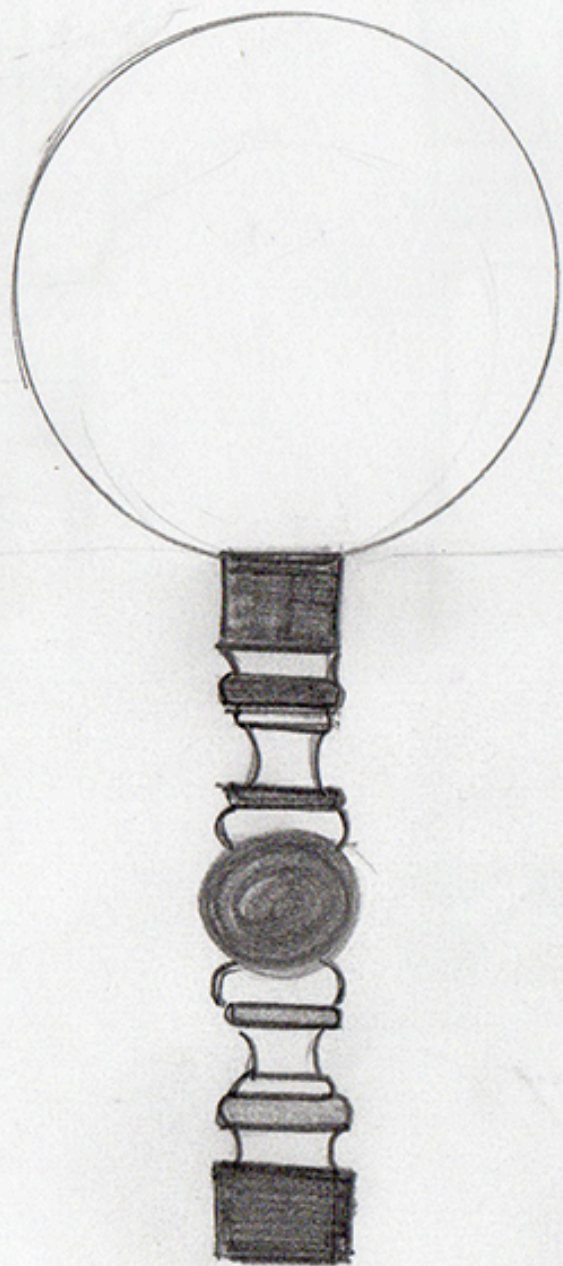
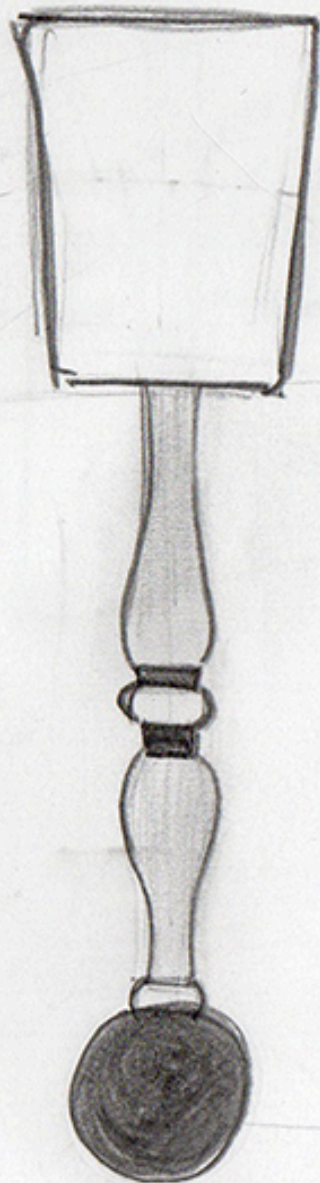



artesanas
de colombia

Ficha Técnica

Laboratorio

Amules 3

Línea

Soquelá

Producto

Pieza

Materias Primas

Plata

Piedras Semip.

Paleta de Color

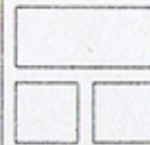

Costo

Fecha

Boceto 1 de 1

Referente

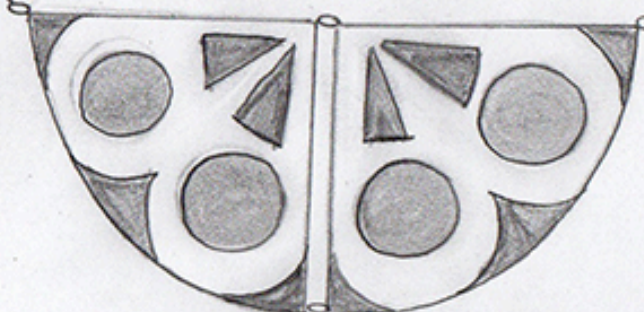
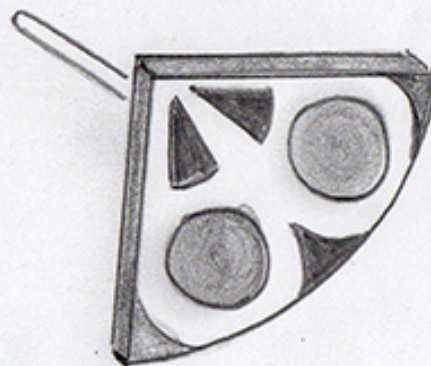
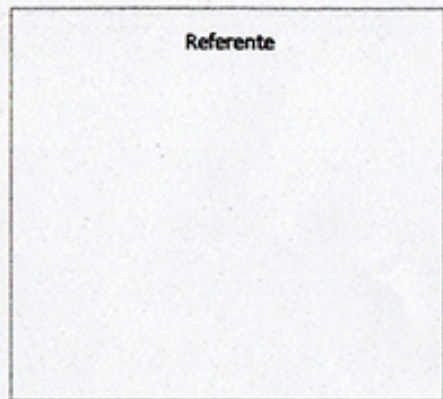



artesánías
de colombia

Ficha Técnica

Laboratorio

Línea

Producto

Pieza

Materias Primas

Plata
Piedras Semp

Paleta de Color

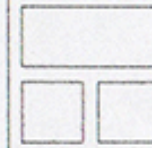

Costo

Sept 2014

Fecha

Boceto 1 de 1

Referente

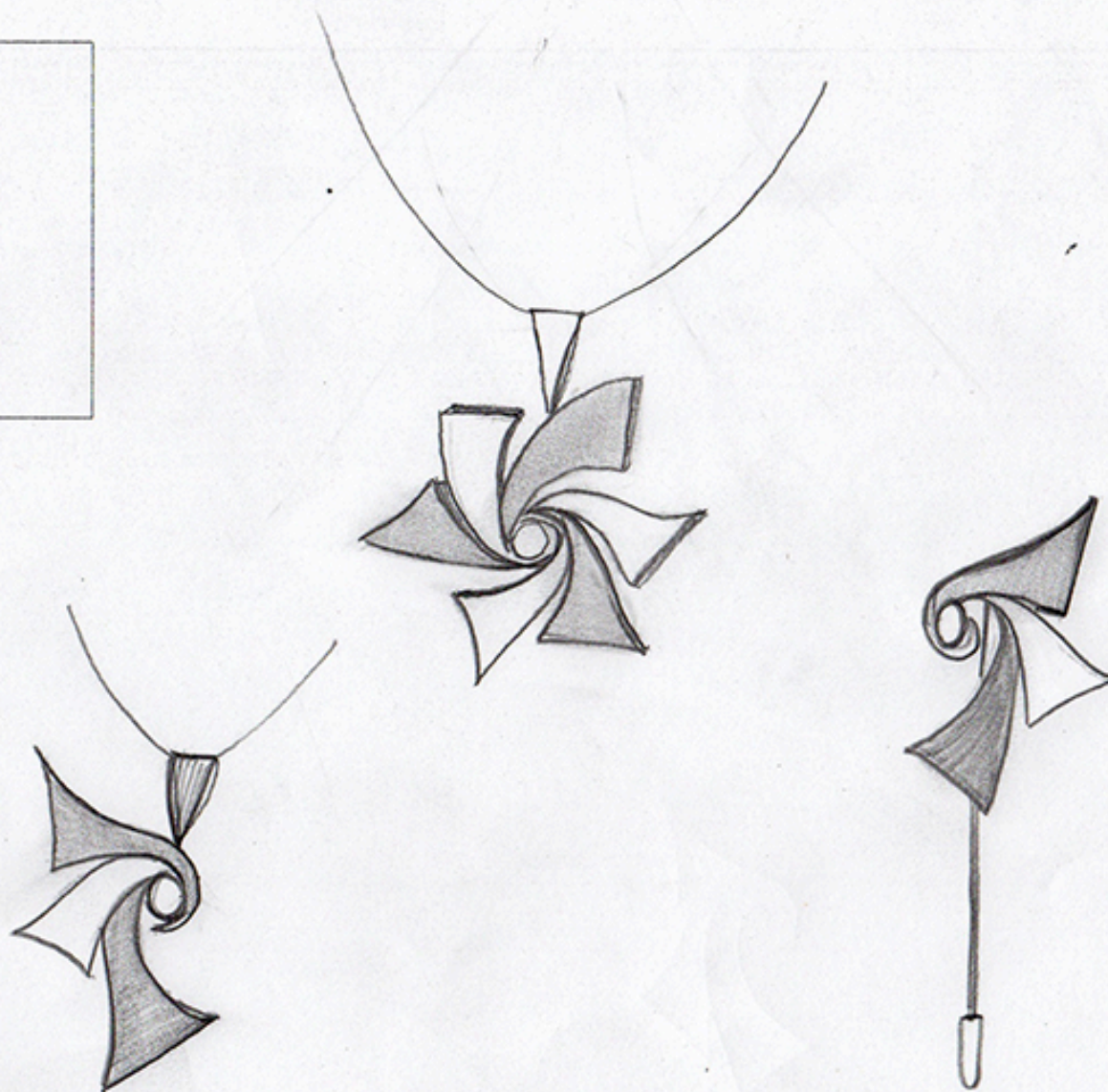
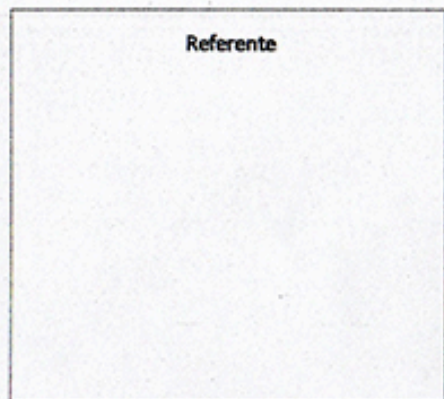



artesanas
de colombia

Ficha Técnica

Laboratorio

Mamata-1
Línea

Producto

Pieza

Materias Primas

Plata
Pinta

Paleta de Color

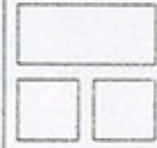

Costo

sept / 2014
Fecha

Boceto 1 de 1

Referente

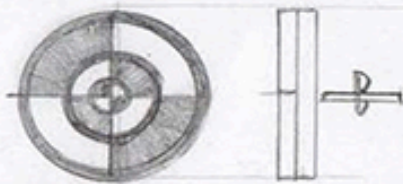

topo

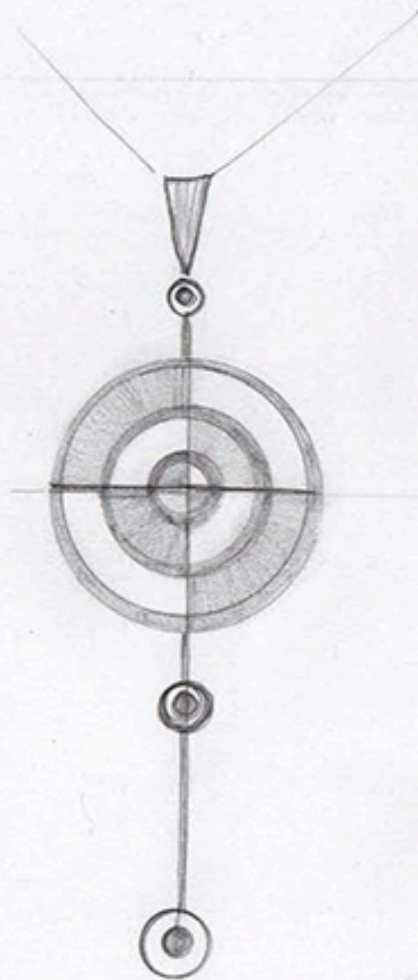

Dije

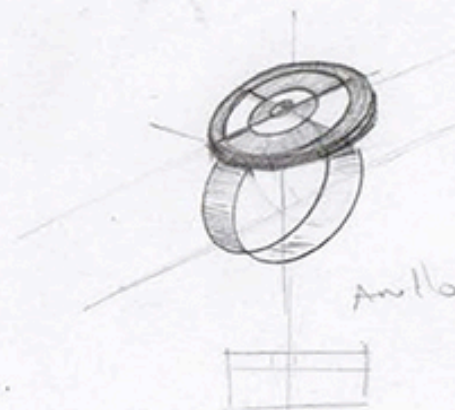

Anillo



artesañas
de colombia

Ficha Técnica

Laboratorio

Hamato

Línea

Joyeria

Producto

Pieza

Materias Primas

Plata
Dorado color

Paleta de Color



Costo

Sept 2014

Fecha

Boceto 1 de 1

Referente

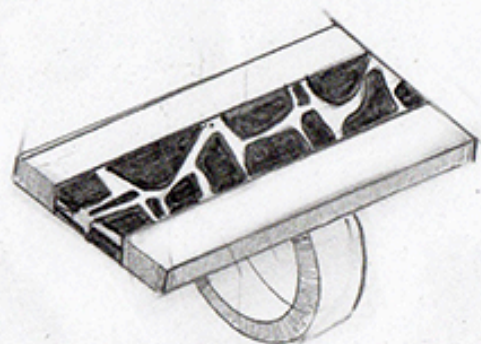
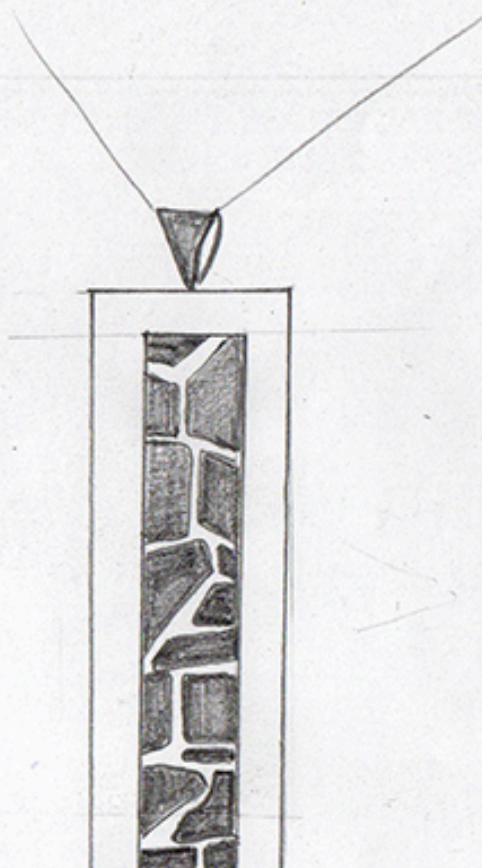



artesanas
de colombia

Ficha Técnica

Laboratorio

Marmato 2
Línea

Producto

Pieza

Materias Primas

Plata
Pinta

Paleta de Color

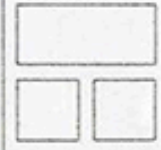

Costo

Fecha

Boceto 1 de 1

Referente

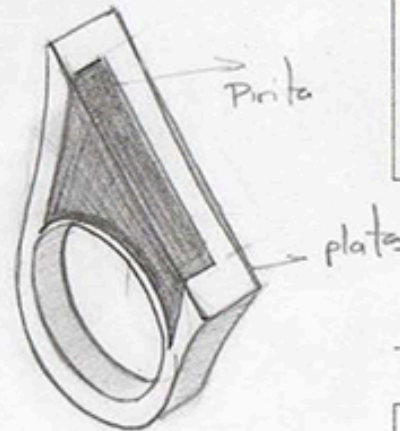
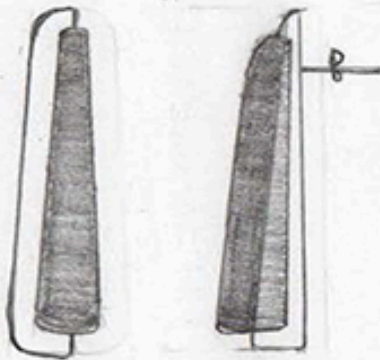



artesanas
de colombia

Ficha Técnica

Laboratorio

Hamato

Únea

Producto

Pieza

Materias Primas

*Plata
Pinta Color*

Paleta de Color

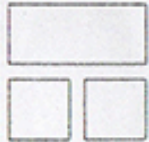

Costo

Sept 2014

Fecha

Boceto 1 de 1

Referente

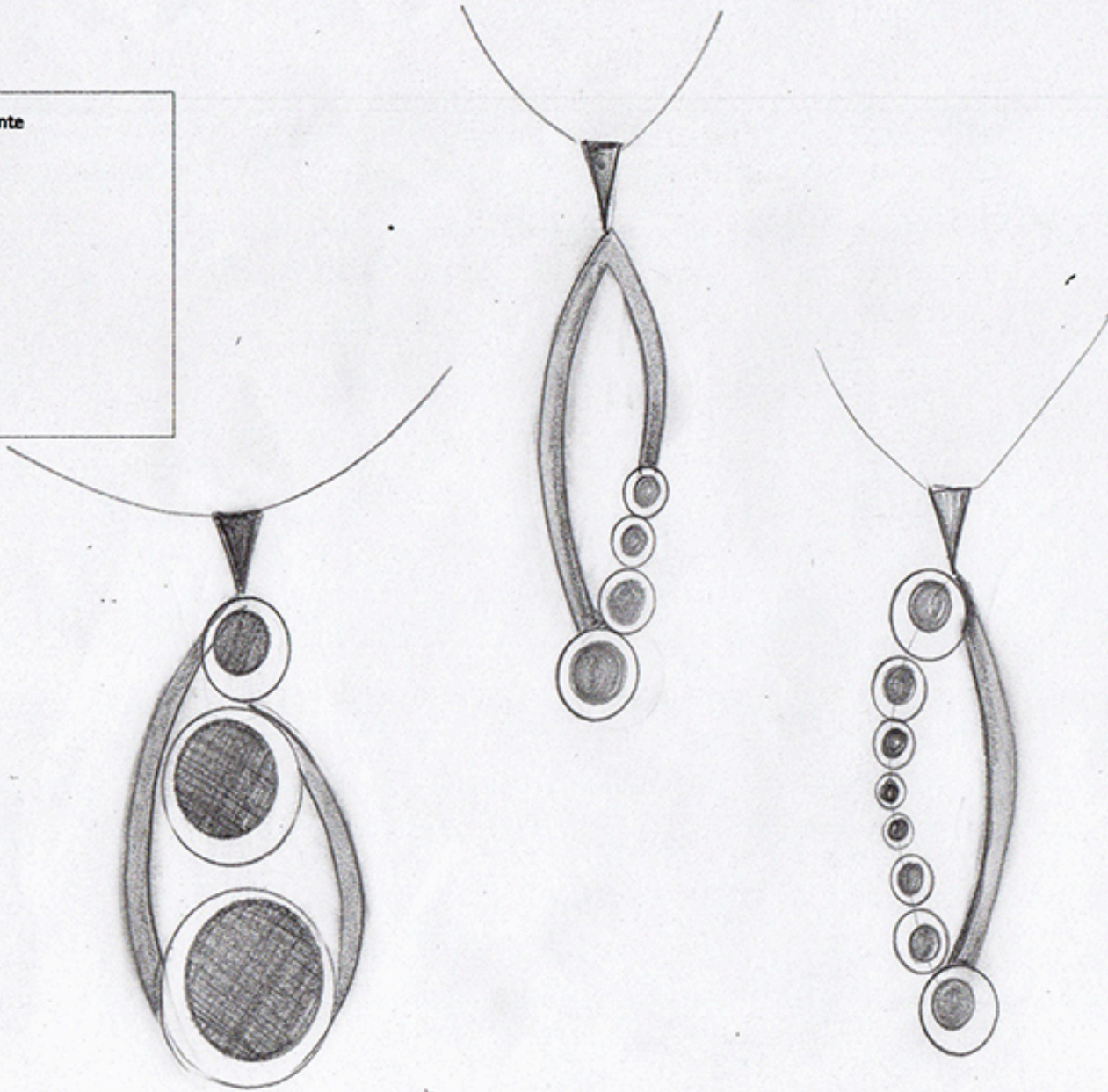



artesanas
de colombia

Ficha Técnica

Laboratorio

Marmato

Línea

Joyas

Producto

Pieza

Materias Primas

*Plata
pinta - Color*

Paleta de Color

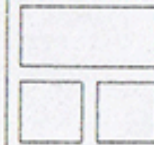

Costo

Sept 2014

Fecha

Boceto 1 de 1

Referente

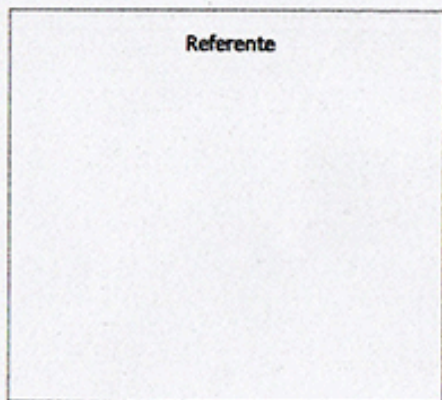



artesañas
de colombia

Ficha Técnica

Laboratorio

JOYERÍA

Línea

DIJES ANILLO
Producto

Pieza

Materias Primas

PLATA
PIRITA

Paleta de Color



Costo

SEPT 2014

Fecha

Boceto 1 de 1

Referente

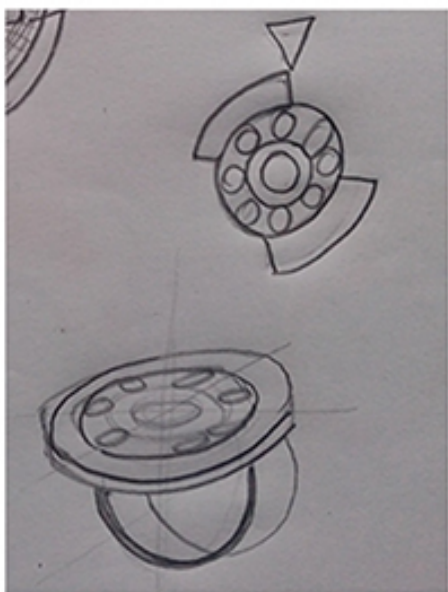
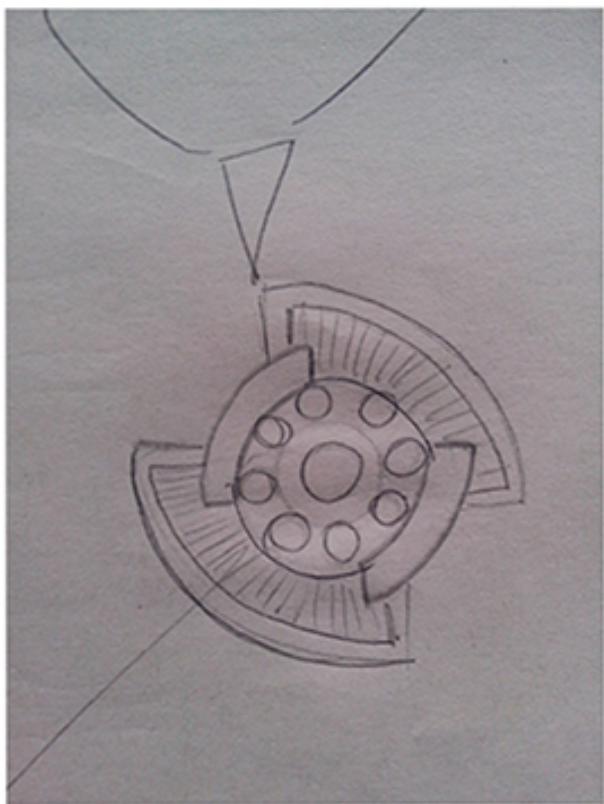
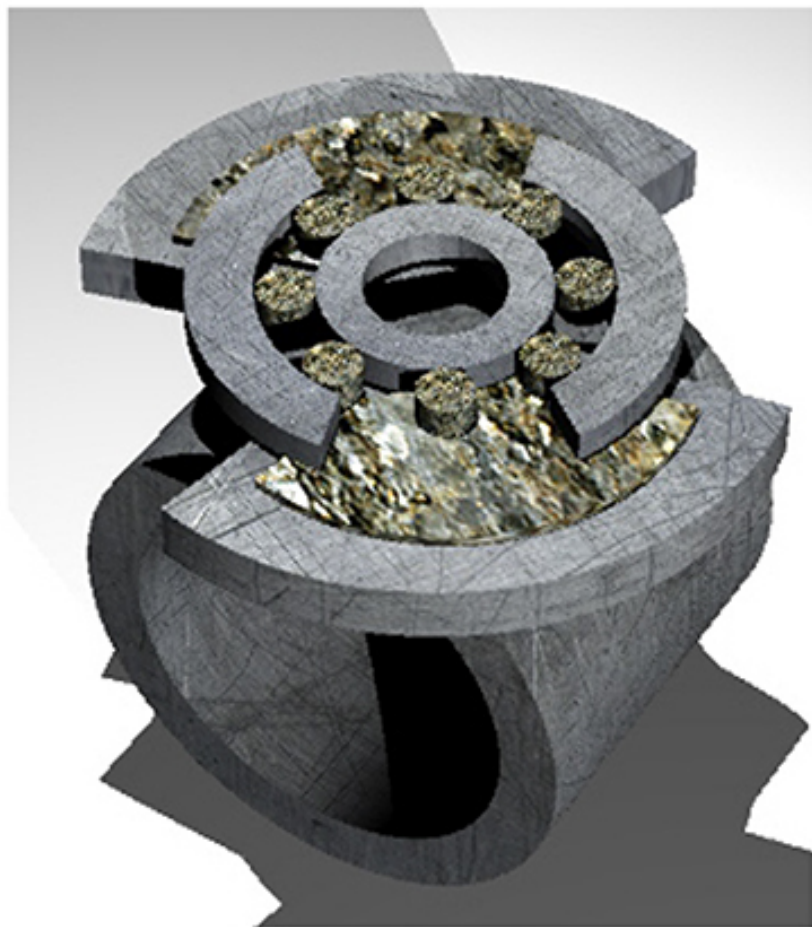



artesañas
de colombia

Ficha Técnica

Laboratorio

JOYERÍA

Línea

DIJE, COLLAR Y ARETE
Producto

Pieza

Materias Primas

PLATA
PIEDRAS
SEMPRECIOSAS

Paleta de Color



Costo

SEPT 2014

Fecha

Boceto 1 de 1

Referente

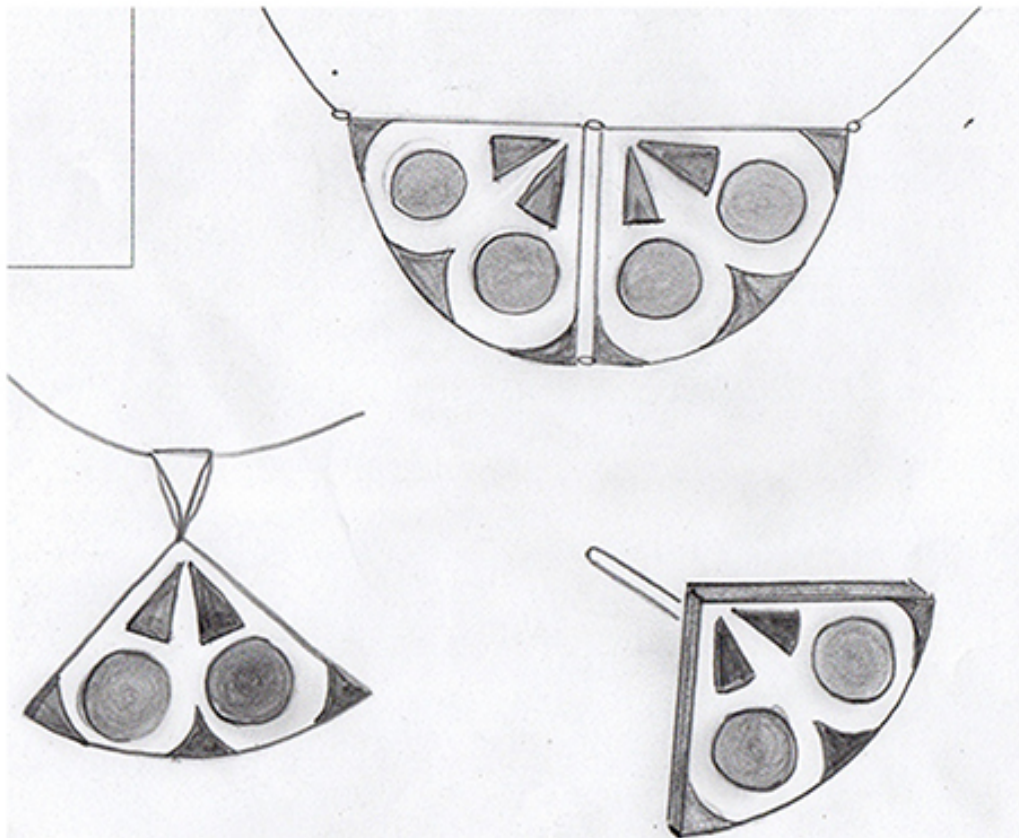
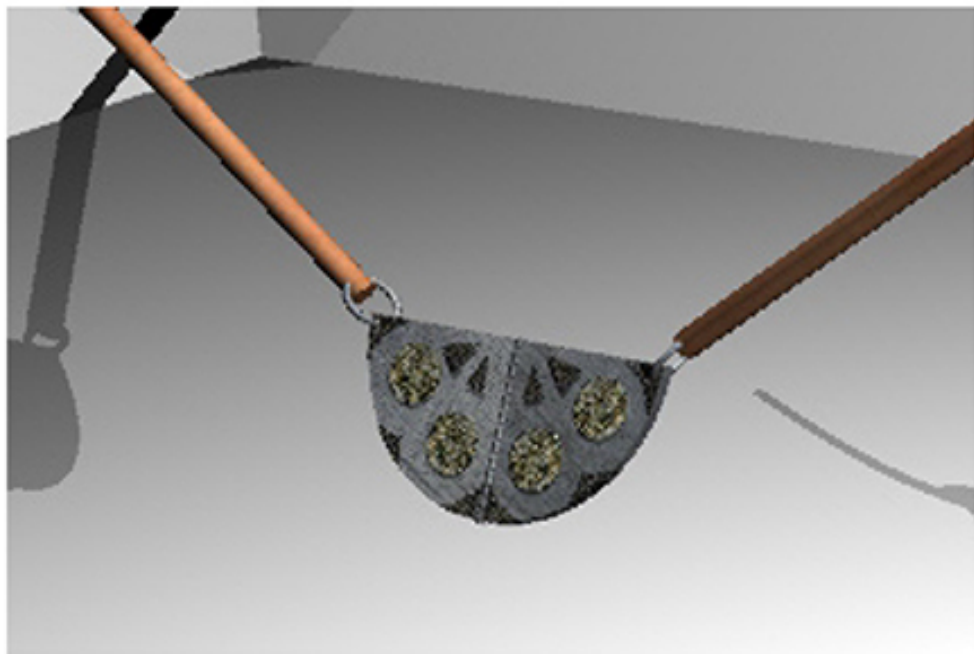
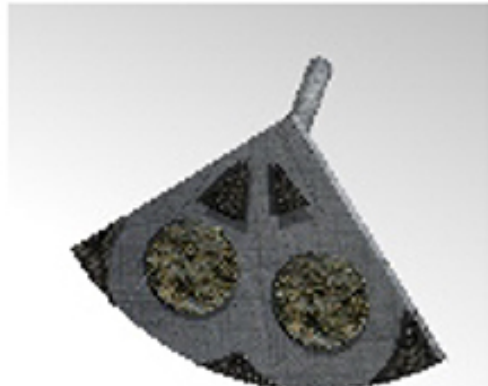



artesañas
de colombia

Ficha Técnica

Laboratorio

JOYERÍA

Línea

DIJES, ARETE Y PRENDEDOR
Producto

Pieza

Materias Primas

PLATA
PIEDRAS
SEMIPRECIOSAS

Paleta de Color



Costo

SEPT 2014

Fecha

Boceto 1 de 1

Referente

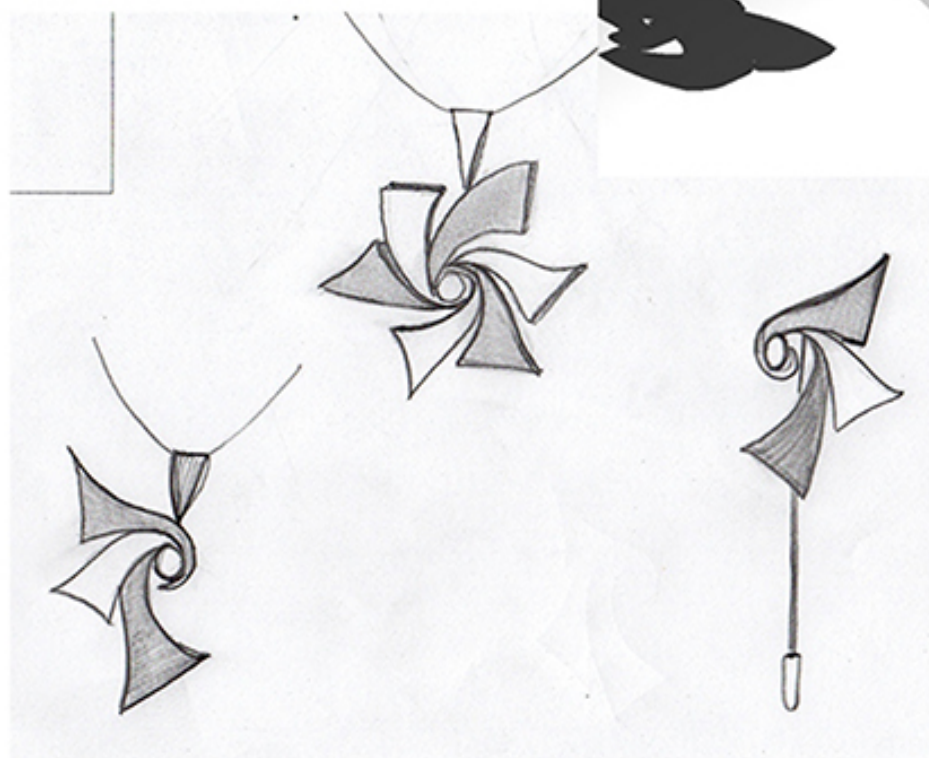
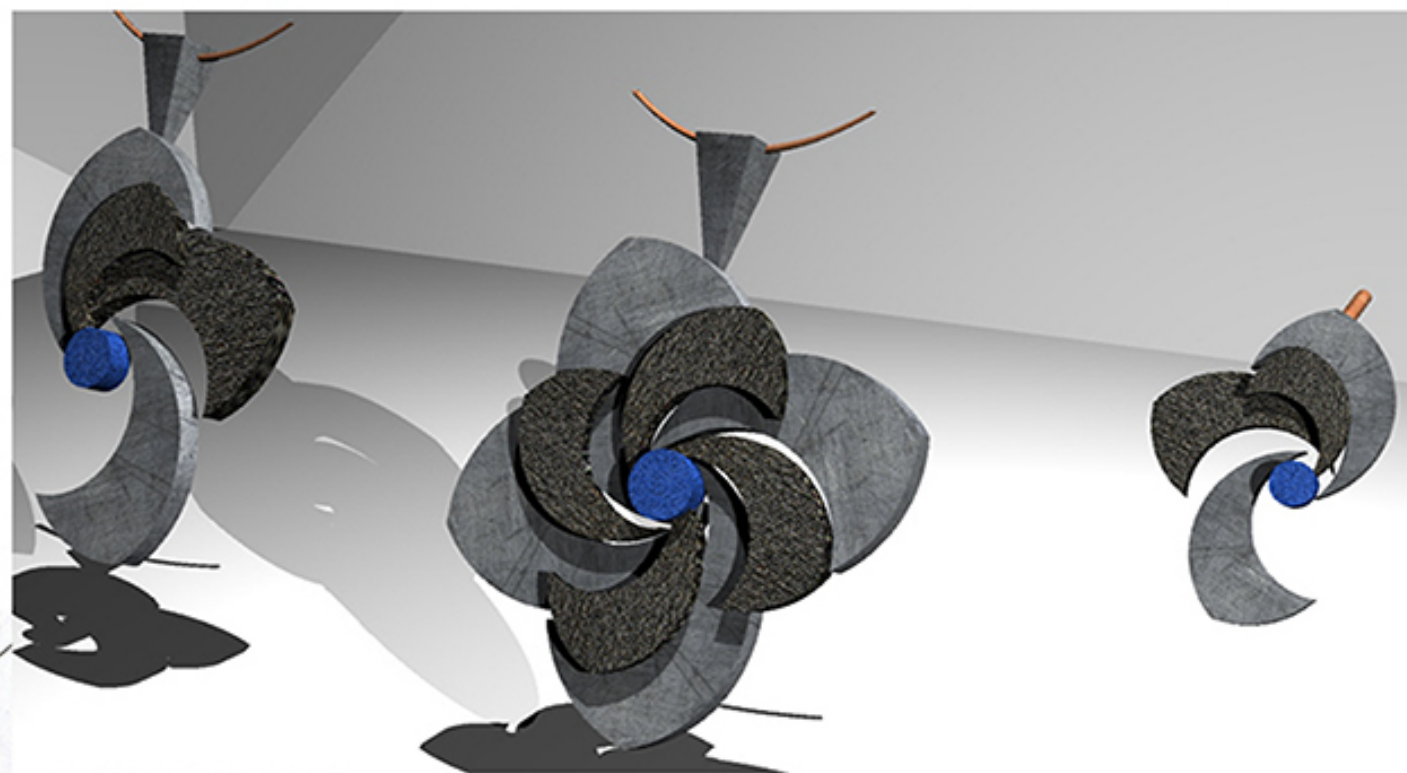



artesañas
de colombia

Ficha Técnica

Laboratorio

JOYERÍA

Línea

COLLAR, ARETES Y ANILLO
Producto

Pieza

Materias Primas

PLATA
PIEDRAS
SEMIPRECIOSAS

Paleta de Color

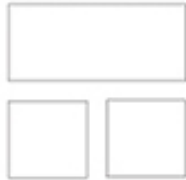

Costo

SEPT 2014

Fecha

Boceto 1 de 1

Referente

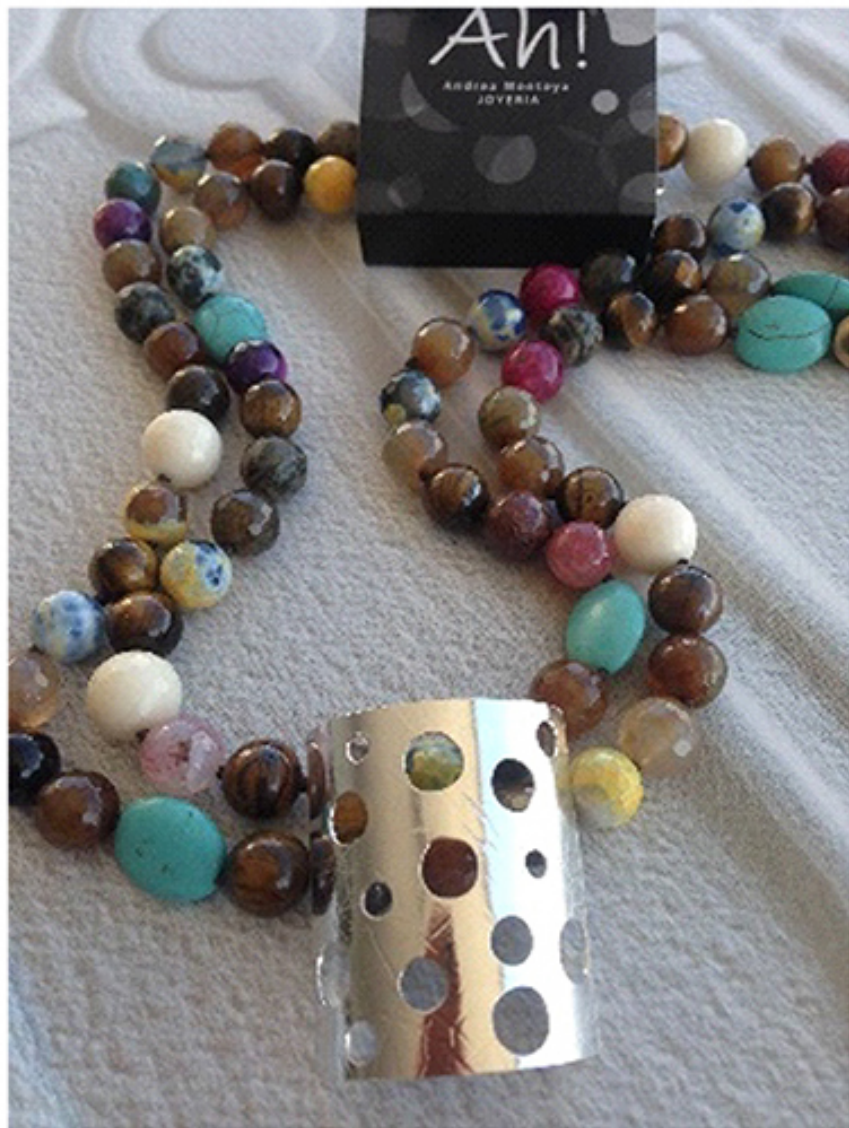

PROTOTIPOS



artesañas
de colombia

Ficha Técnica

Laboratorio

JOYERÍA

Línea

DIJES, ARETE Y PRENDEDOR
Producto

Pieza

Materias Primas

PLATA

Paleta de Color



Costo

SEPT 2014

Fecha

Boceto 1 de 1

Referente



PROTOTIPOS



artesañas
de colombia

Ficha Técnica

Laboratorio

JOYERÍA

Línea

DIJES, ARETES
Producto

Pieza

Materias Primas

PLATA
PIEDRAS
SEMIPRECIOSAS

Paleta de Color



Costo

SEPT 2014

Fecha

Boceto 1 de 1

Referente

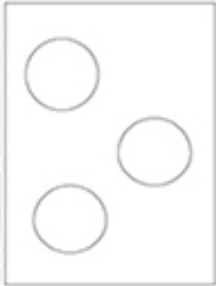

PROTOTIPOS



artesañas
de colombia

Ficha Técnica

Laboratorio

JOYERÍA

Línea

DIJES, ARETE Y PRENDEDOR
Producto

Pieza

Materias Primas

PLATA

Paleta de Color



Costo

SEPT 2014

Fecha

Boceto 1 de 1

Referente



PROTOTIPOS

Referente



artesanías
de colombia

Ficha Técnica

Laboratorio

JOYERÍA

Línea

DIJES, ARETE Y PRENDEDOR
Producto

Pieza

Materias Primas

PLATA
PIEDRAS
SEMIPRECIOSAS

Paleta de Color



Costo

SEPT 2014

Fecha

Boceto 1 de 1

PROTOTIPOS



artesañas
de colombia

Ficha Técnica

Laboratorio

JOYERÍA

Línea

DIJE, ARETES Y PULSERA
Producto

Pieza

Materias Primas

PLATA
PIEDRAS
SEMIPRECIOSAS

Paleta de Color

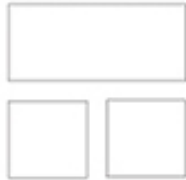

Costo

SEPT 2014

Fecha

Boceto 1 de 1

Referente

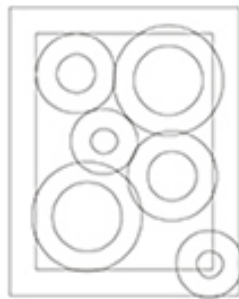

PROTOTIPOS

Referente



PROTOTIPOS



artesañas
de colombia

Ficha Técnica

Laboratorio

JOYERÍA

Línea

COLLAR, PULSERA Y ARETES
Producto

Pieza

Materias Primas

PLATA
PIEDRAS
SEMIPRECIOSAS

Paleta de Color



Costo

SEPT 2014

Fecha

Boceto 1 de 1

Referente



artesañas
de colombia

Ficha Técnica

Laboratorio

JOYERÍA

Línea

DIJE, ARETES

Producto

Pieza

Materias Primas

BRONCE CON BAÑO DE
ORO

Paleta de Color



Costo

SEPT 2014

Fecha

Boceto 1 de 1

PROTOTIPOS



artesañas
de colombia

Ficha Técnica

Laboratorio

JOYERÍA

Línea

DIJE, ARETES Y PULSERA
Producto

Pieza

Materias Primas

PLATA
S

Paleta de Color



Costo

SEPT 2014

Fecha

Boceto 1 de 1

Referente

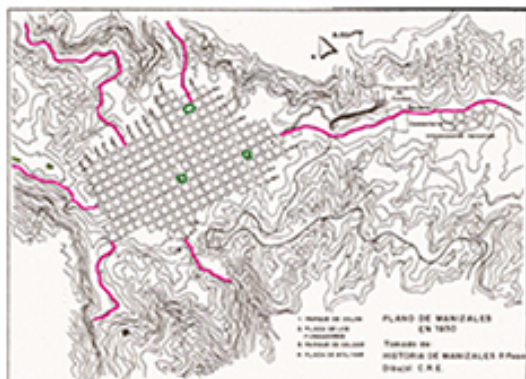

PROTOTIPOS



artesañas
de colombia

Ficha Técnica

Laboratorio

JOYERÍA

Línea

ARETES, DIJES

Producto

Pieza

Materias Primas

BRONCE CON BAÑO DE
ORO

Paleta de Color



Costo

SEPT 2014

Fecha

Boceto 1 de 1

Referente



PROTOTIPOS



artesañas
de colombia

Ficha Técnica

Laboratorio

JOYERÍA

Línea

ARETES, DIJES, ANILLO
Producto

Pieza

Materias Primas

PLATA TEXTURADA

Paleta de Color



Costo

SEPT 2014

Fecha

Boceto 1 de 1

Referente

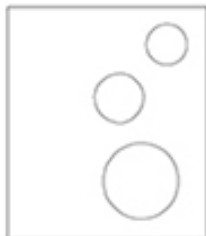

PROTOTIPOS



artesañas
de colombia

Ficha Técnica

Laboratorio

Línea
*Periconotas
Abend's*
Producto

Pieza

Materias Primas

*Madera - Rosinada
Cuero - Repujado*

Paleta de Color



Costo

Sep/2014
Fecha

Boceto 1 de 1

Referente

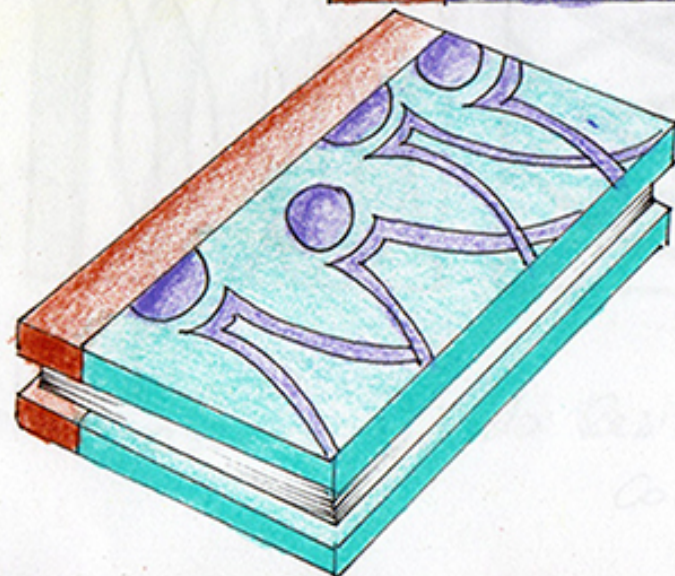
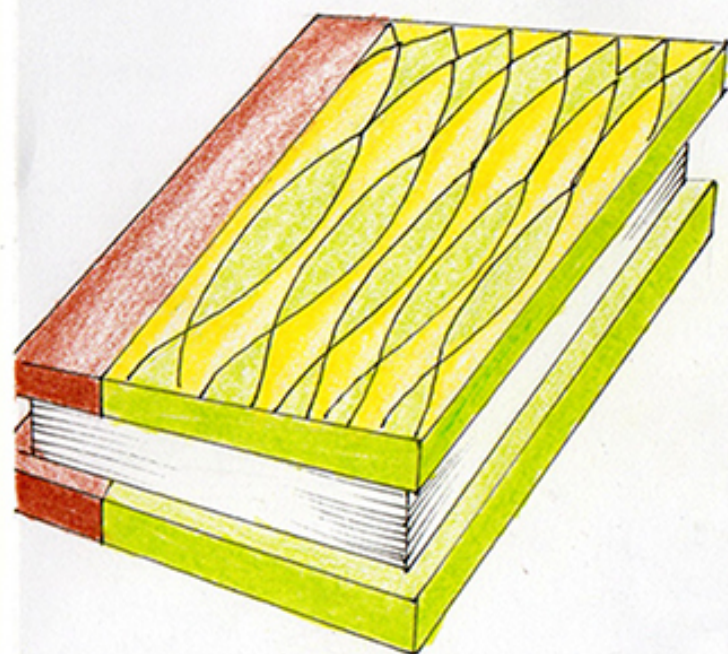
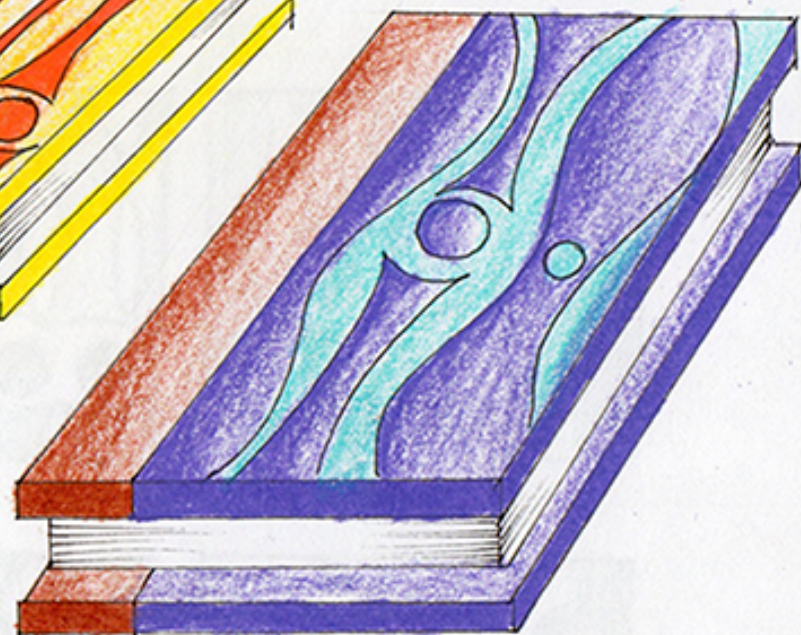
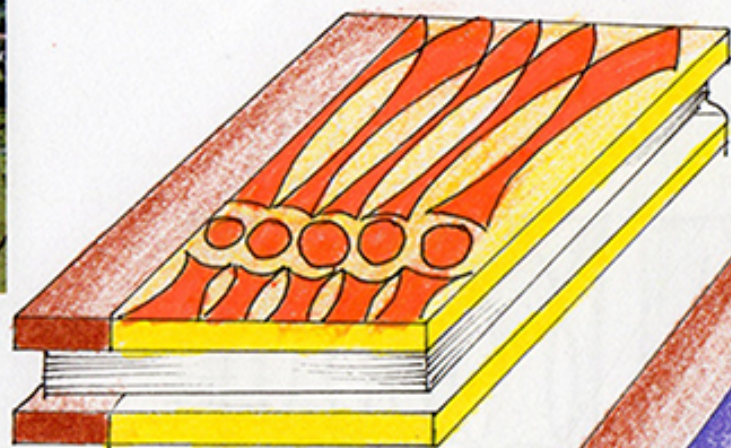

AGENDAS

u

Laboratorio



1

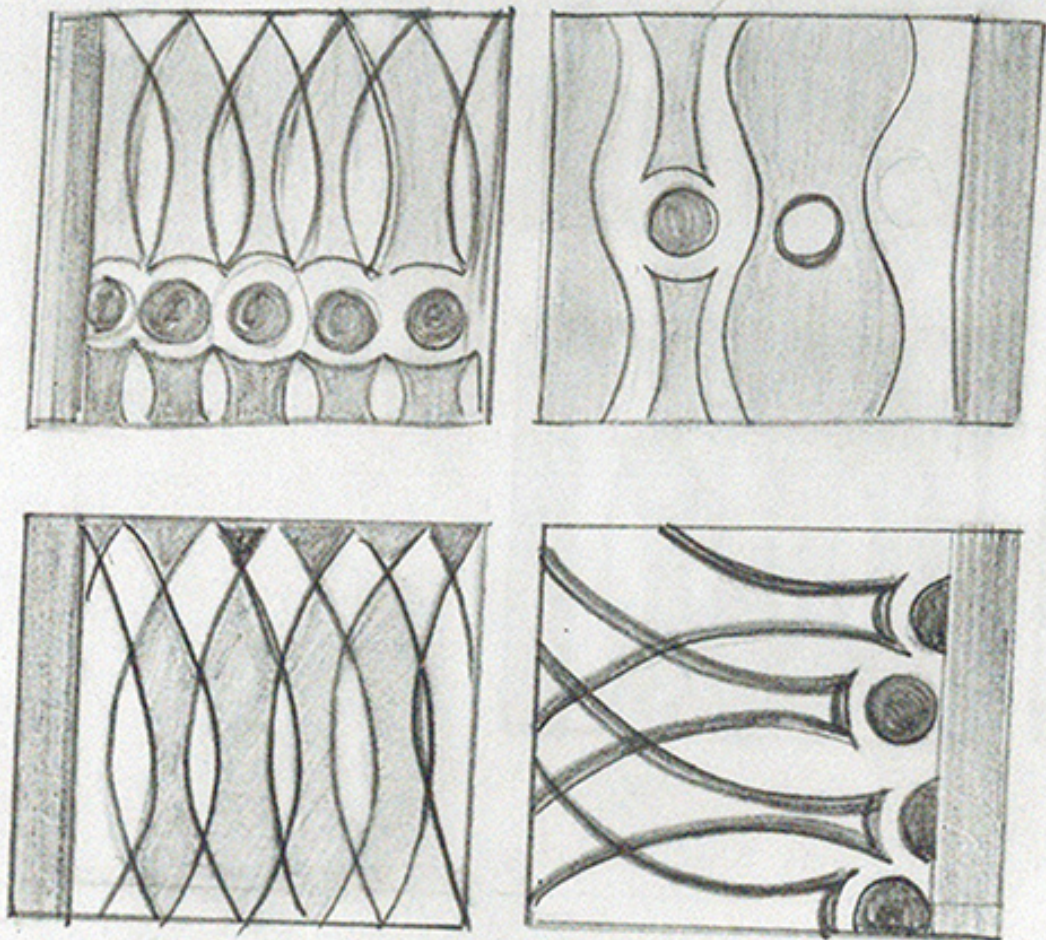

Línea

Algodón y
Producto
Porcelana

Pieza

Materias Primas

Maderas
Cuero

Paleta de Color



Costo

Sept 2014
Fecha

Boceto 1 de 1

↓
DISEÑO unificado Resinado



artesanas
de colombia

Ficha Técnica

Laboratorio

Línea

Abenda
Producto
porruñotes

Pieza

Materias Primas

*Madera
Resinados*

Paleta de Color



Costo

Sep 12/14
Fecha

Boceto 1 de 1

Referente

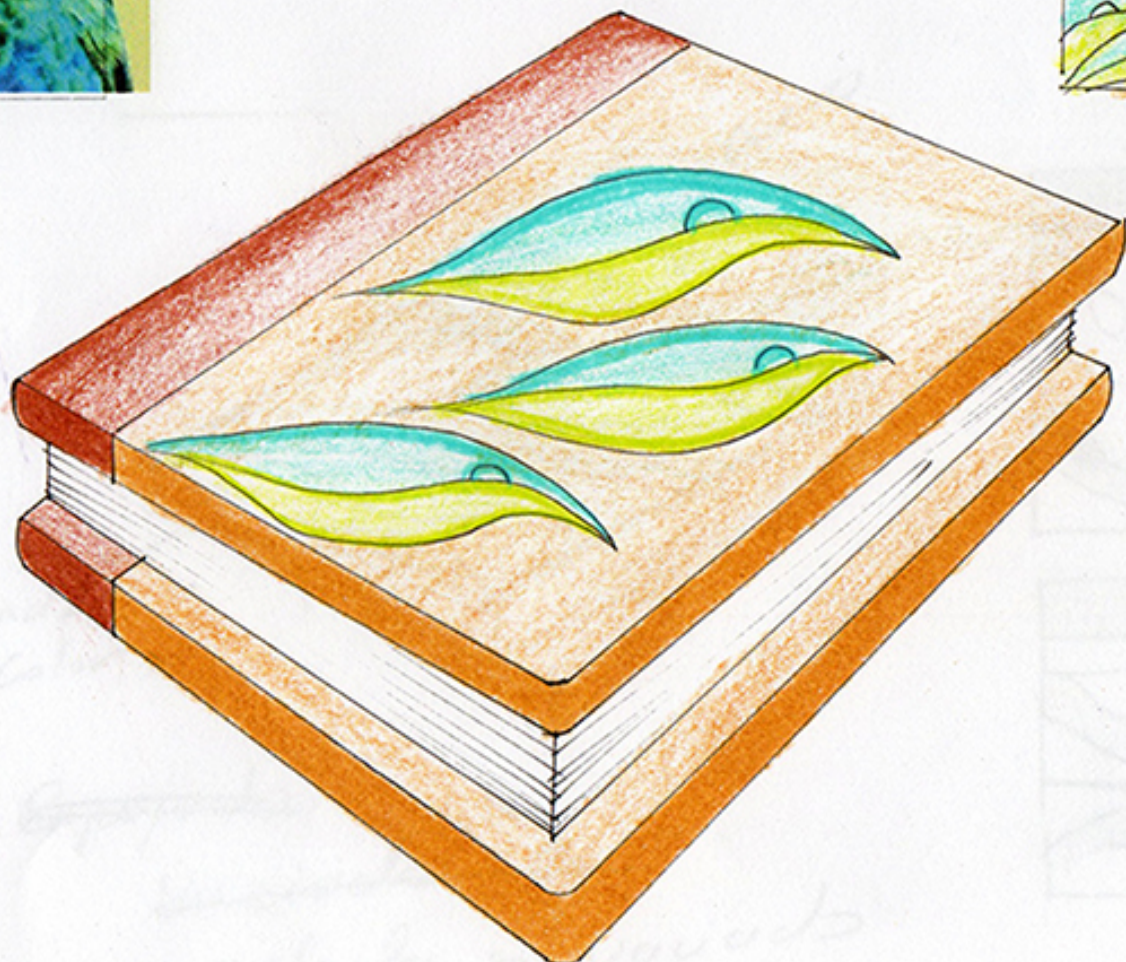

Referente



artesanas
de colombia

Ficha Técnica

Laboratorio

Línea

Artes y
Producto
Porcelanas

Pieza

Materias Primas

Madera
Cuero

Paleta de Color



Costo

Sept 2014
Fecha

Boceto 1 de 1

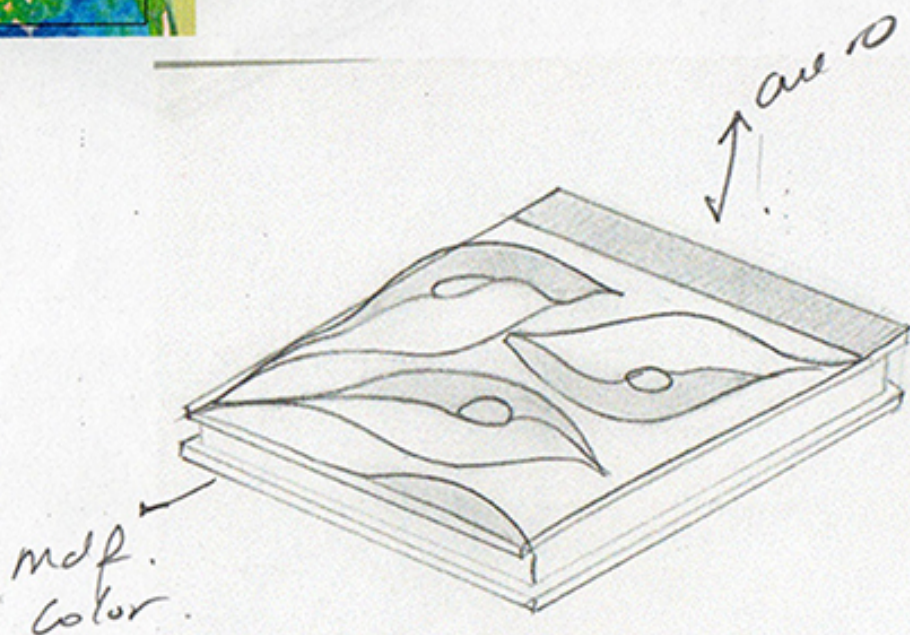

~~Repetida~~
Variada ca
calada y variada
Resinada

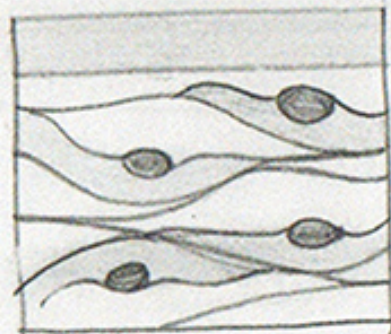



artesanías
de colombia

Ficha Técnica

Laboratorio

Línea

*Algodones y
Productos
Porcelanados*

Pieza

Materias Primas

*Maderas
Cuero*

Paleta de Color



Costo

Sept 2014

Fecha

Boceto 1 de 1

Referente



①

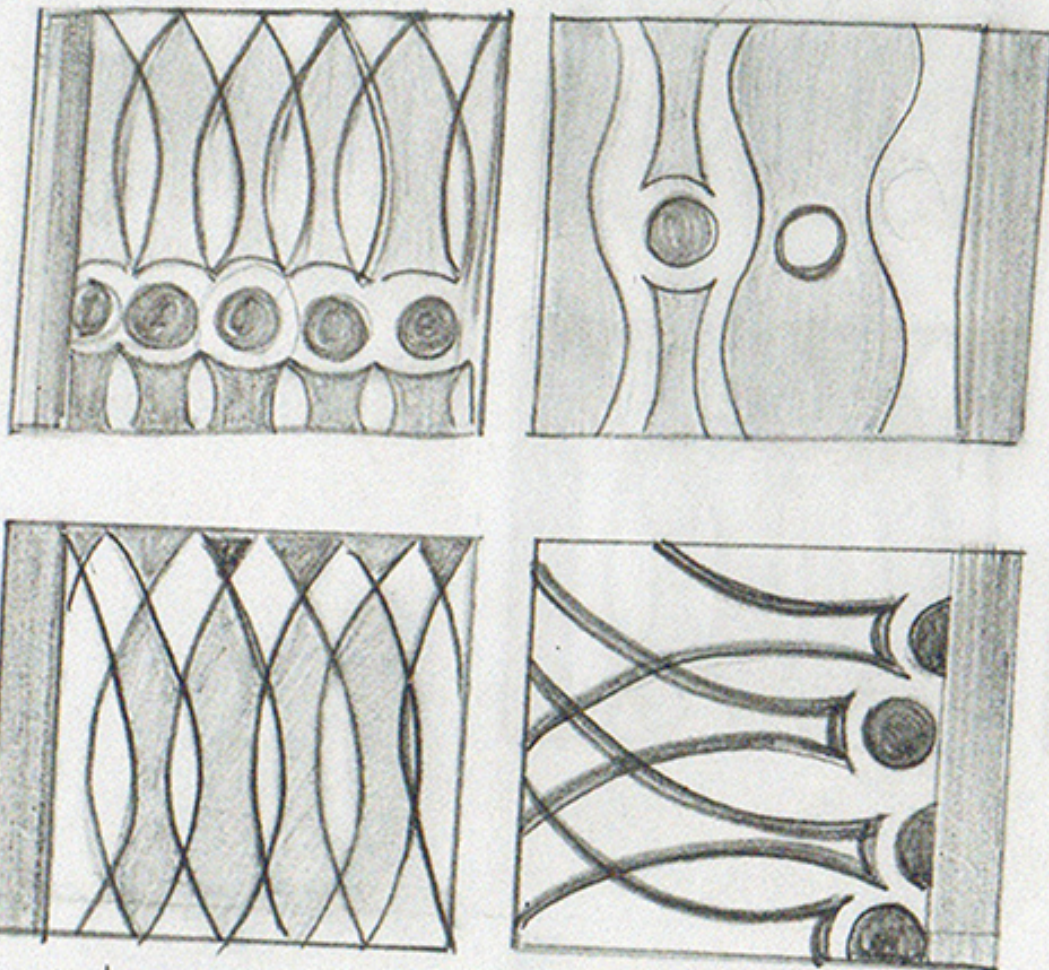

oscuro variado Resinado
color



artesañas
de colombia

Ficha Técnica

Laboratorio

Línea

Espeso, Jeso

Producto

Banca

Pieza

Materias Primas

*Madera
Cavolva*

Paleta de Color

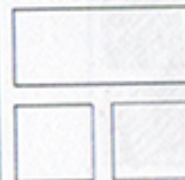

Costo

Sept/2014

Fecha

Boceto 1 de 1

Referente



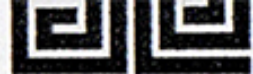

Laboratorio

Entrelacado

Línea

Especo Mesa

Producto

Burice

Pieza

Materias Primas

*Caraca
fodre*

Paleta de Color



Costo

Sept 2014

Fecha

Boceto 1 de 1

Referente

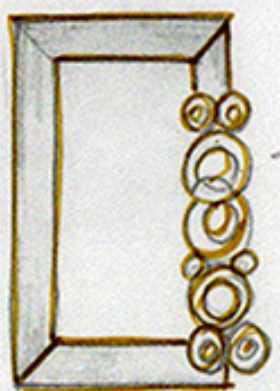

Guadua

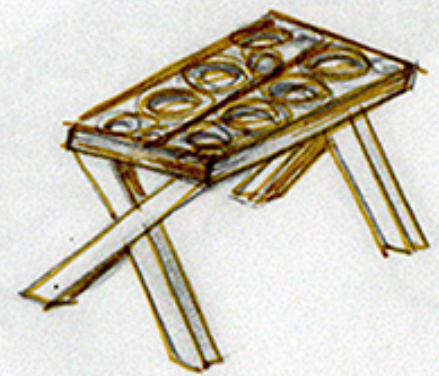

madre



artesañas
de colombia

Ficha Técnica

Laboratorio

Línea

baleras

Producto

Pieza

Materias Primas

*Madroño
Pino
cedro*

Paleta de Color



Costo

Sept/2014

Fecha

Boceto 1 de 1

Referente

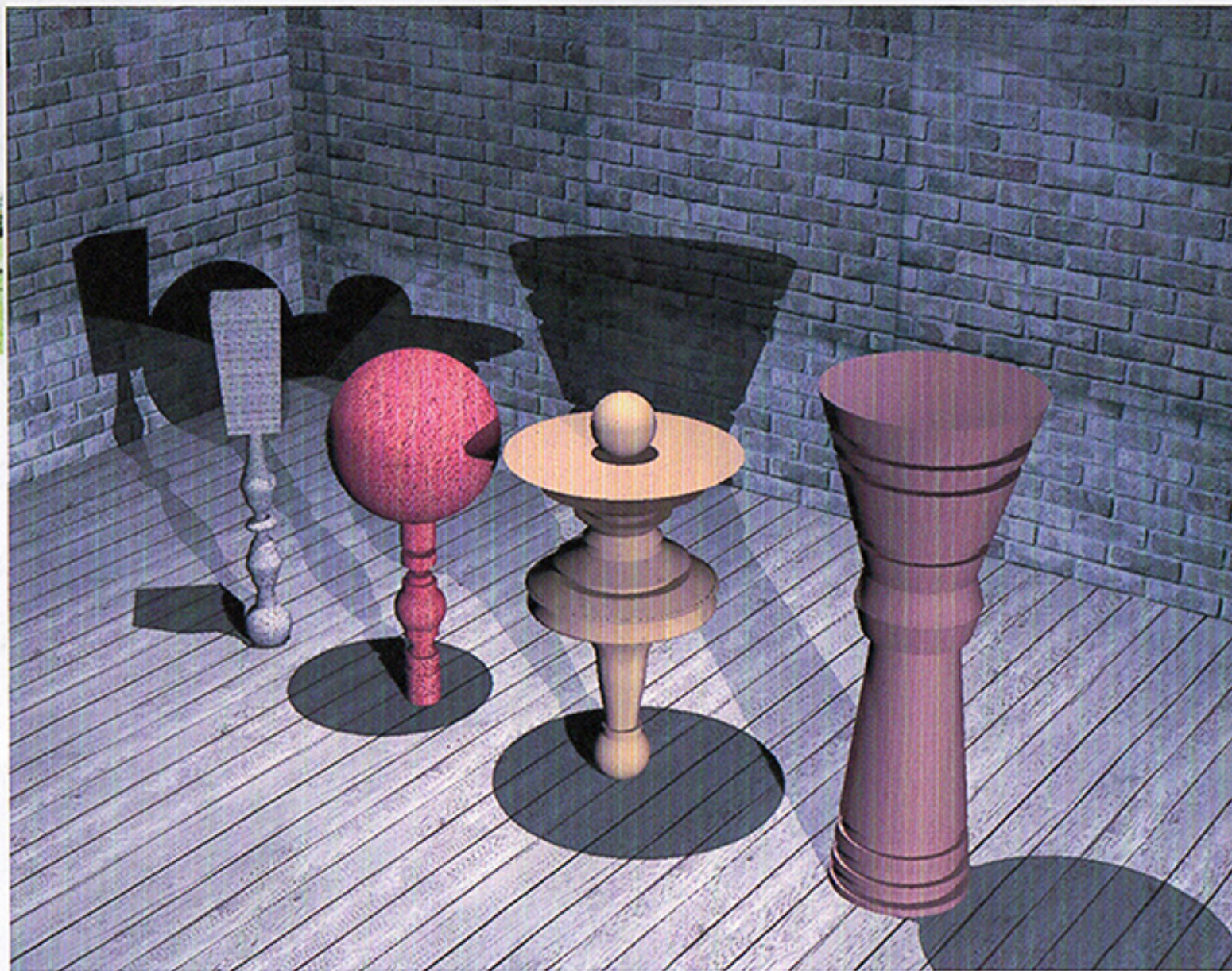



artesañas
de colombia

Ficha Técnica

Laboratorio
Balcón
Liquorera

Línea

Balero

Producto

balero

Pieza

Materias Primas

Madera

Paleta de Color



Costo

Sept 2014

Fecha

Boceto 1 de 1

Referente





artesañas
de colombia

Ficha Técnica

Laboratorio

Balcones

Línea

balcones

Producto

Pieza

Materias Primas

Madera
Pino
Cedro

Paleta de Color



Colorida
Variedad
tonos
Intensos

Costo

Sept 2014

Fecha

Boceto 1 de 1

Referente



madera
fornada
color

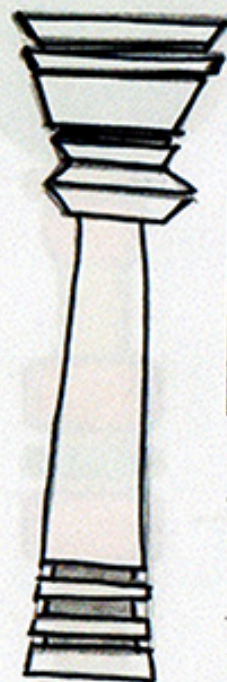
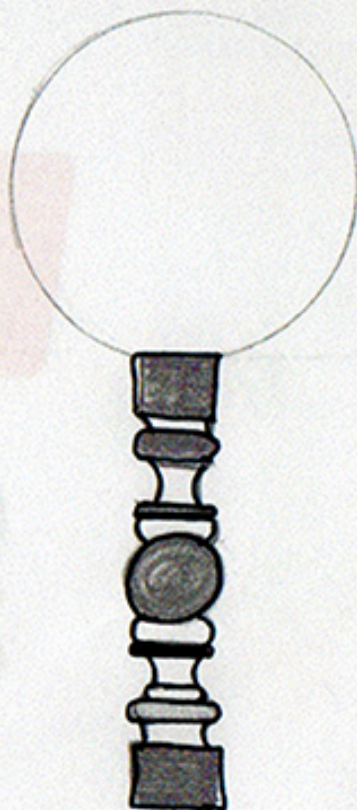
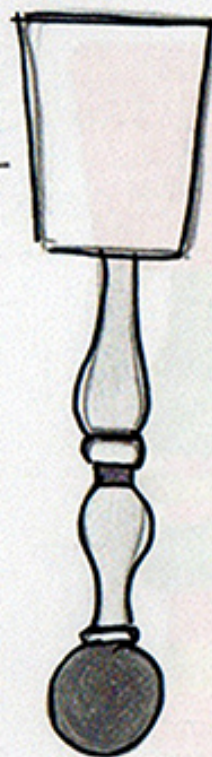



artesanas
de colombia

Ficha Técnica

Laboratorio

Balcones

Línea

balero

Producto

Pieza

Materias Primas

*Hadero
Pino
cedro*

Paleta de Color

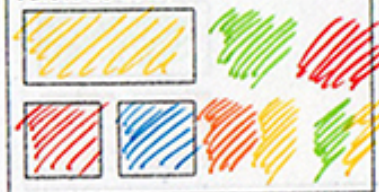

Costo

Sept 2014

Fecha

Boceto 1 de 1

Referente

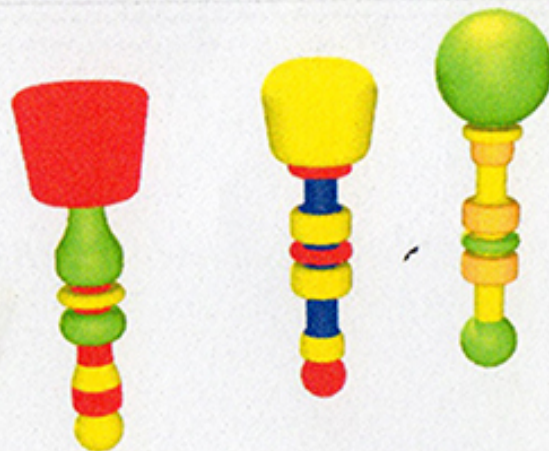
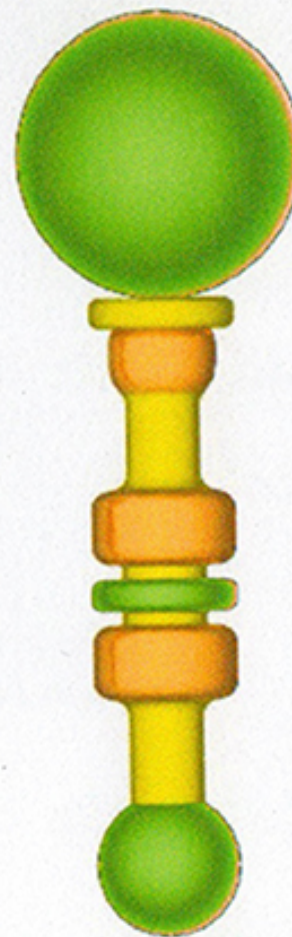
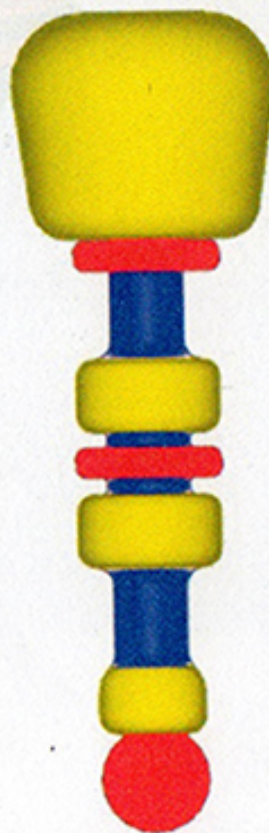

Referente



artesanías
de colombia

Ficha Técnica

Laboratorio

Andrés

Línea

Cafemática

Producto

Juego Café

Pieza

Materias Primas

Maderas

Paleta de Color



Costo

Sept 2014

Fecha

Boceto 1 de 1



artesañas
de colombia

Ficha Técnica

Laboratorio

Línea

Servilletas

Producto

Pieza

Materias Primas

Guadua

Paleta de Color



natural



Costo

Sept 2014

Fecha

Boceto 1 de 1

Referente

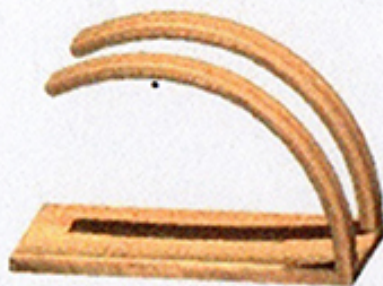

Ficha Técnica

Laboratorio

Línea

Producto

Pieza

Materias Primas

Paleta de Color

Costo

Fecha

Boceto 1 de 1

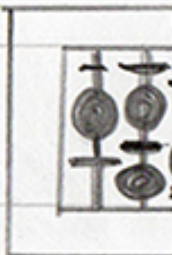
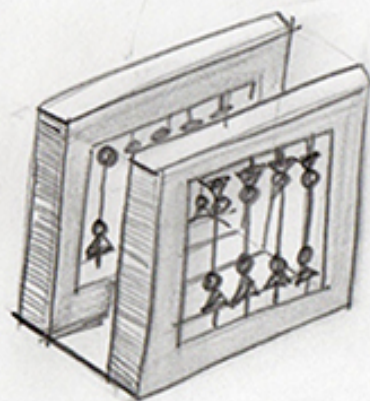
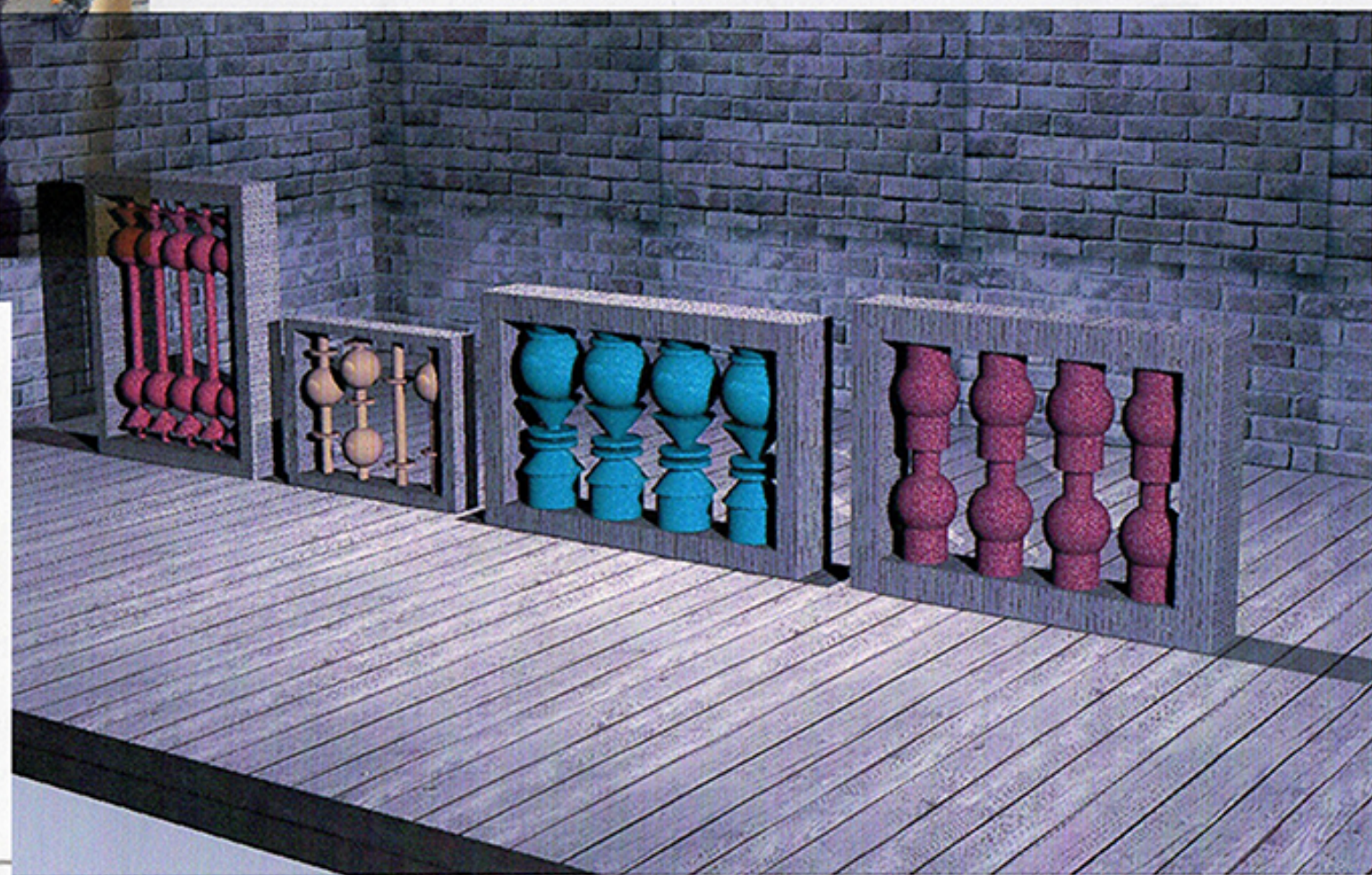



artesanías
de colombia

Ficha Técnica

Laboratorio

Línea

Semillero

Producto

Pieza

Materias Primas

Guadua
Guadua

Paleta de Color

natural

Costo

Sept 2014

Fecha

Boceto 1 de 1

Referente

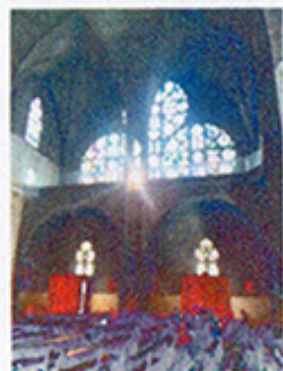



artesañas
de colombia

Ficha Técnica

Laboratorio

Rediseño

Línea

Contenedor

Producto

Pieza

Materias Primas

*Caucho
Alfalfa*

Paleta de Color

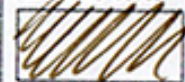

Costo

Sep 2014

Fecha

Boceto 1 de 1

Referente





artesañas
de colombia

Ficha Técnica

Laboratorio

Pilasra

Línea

Soleros

Producto

Pieza

Materias Primas

*Acacia
Pino Cedro*

Paleta de Color

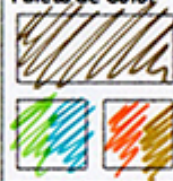

*Diversidad
Color*

Costo

Sept 2014

Fecha

Boceto 1 de 1

Referente

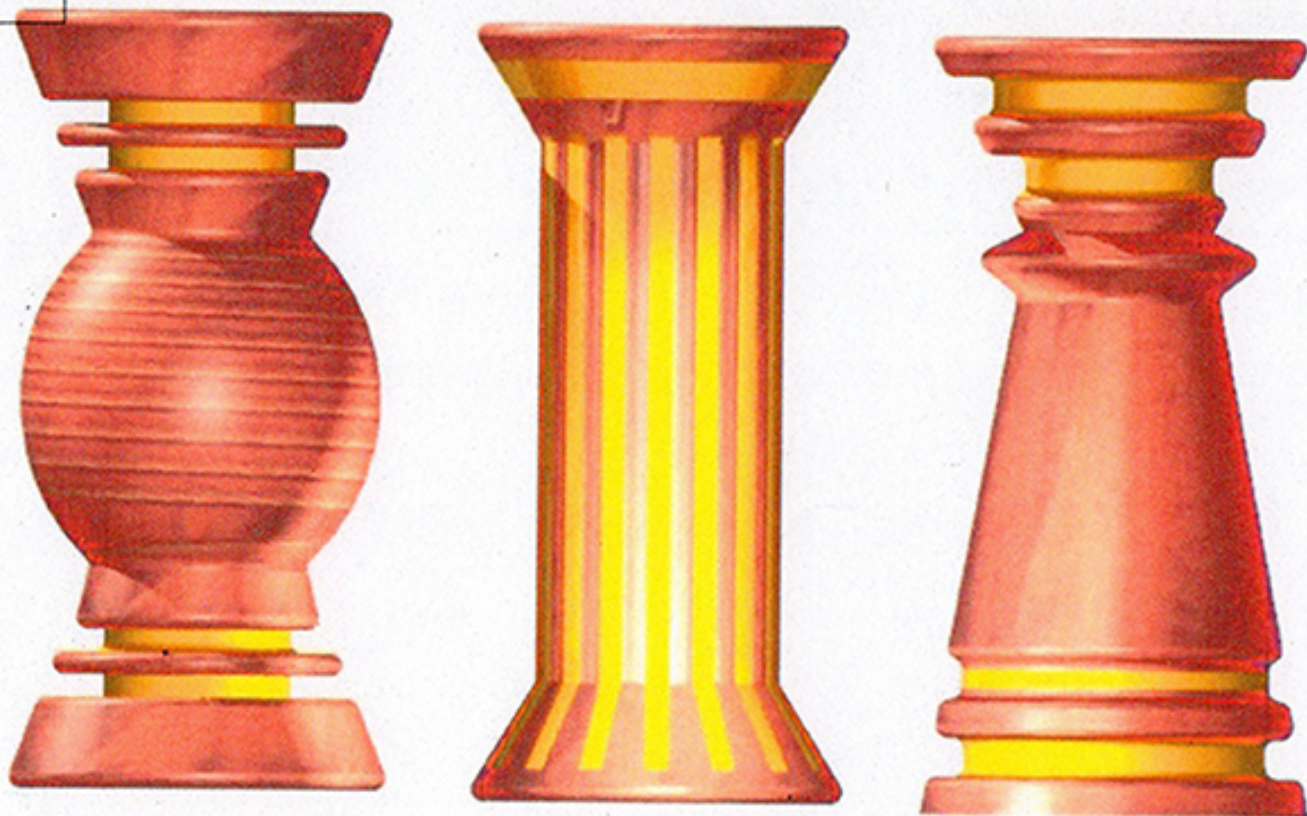



artesanías
de colombia

Ficha Técnica

Laboratorio



Costura
Bejuco



lompasa

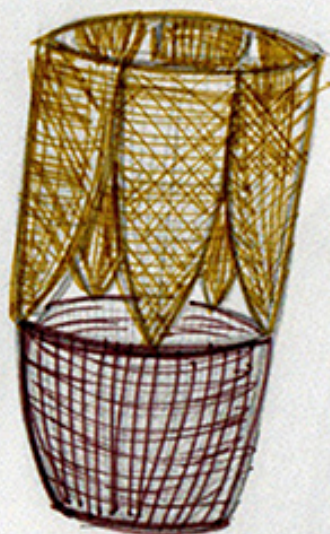

Con hilo



lompasa



lompasa

Línea
Lompasa
Producto
Contenedor
Pieza

Materias Primas

Bejuco

Paleta de Color

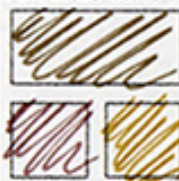

Costo

Sept 2014
Fecha

Boceto 1 de 1

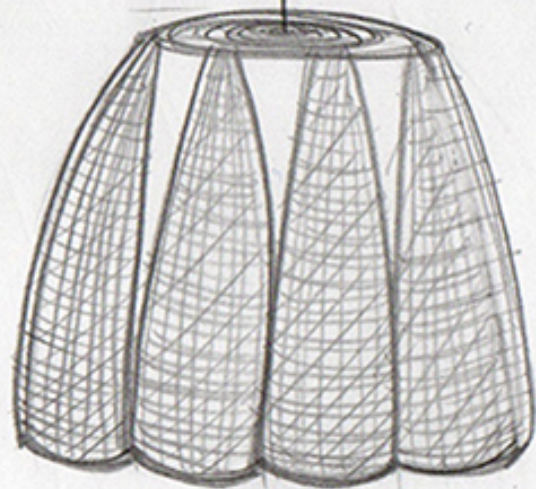
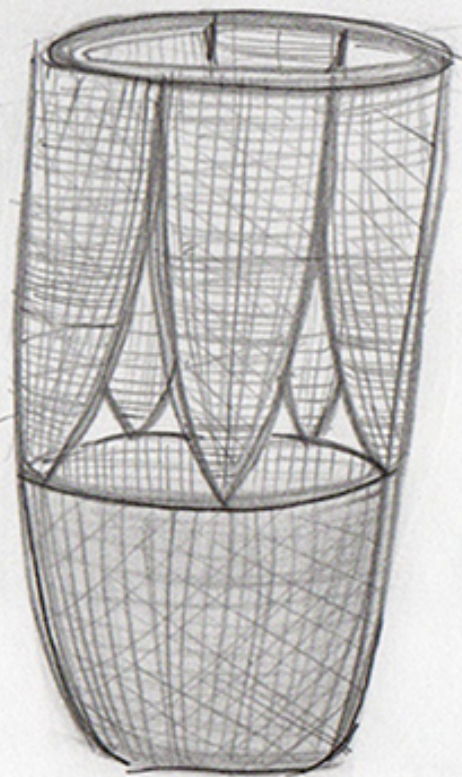
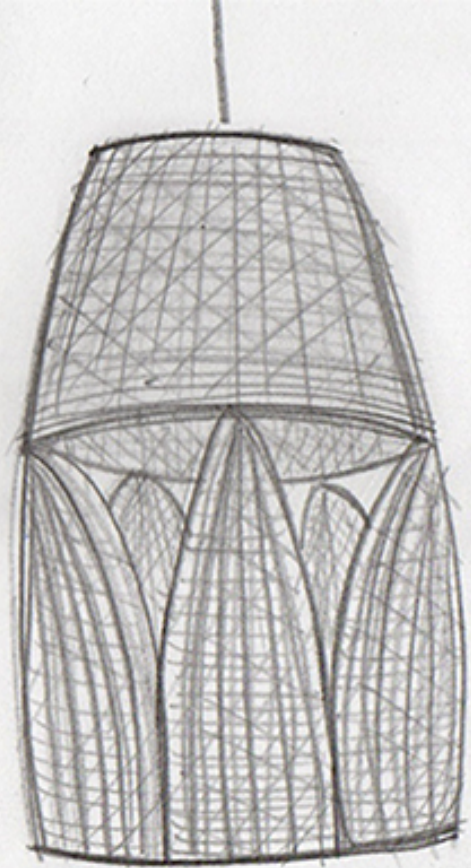



artesanas
de Colombia

Ficha Técnica

Laboratorio

Línea

Lamparas

Producto

Confección

Pieza

Materias Primas

Bejuco

Paleta de Color

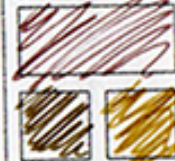

Costo

Sept 2014

Fecha

Boceto 1 de 1

Referente



Leurre hecho

→ Cate oscura

→ clara

Cesta
Bejuco

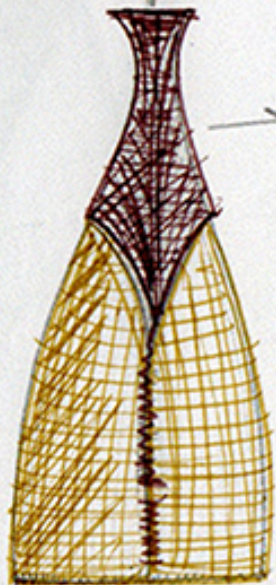

↓
Con feoclar

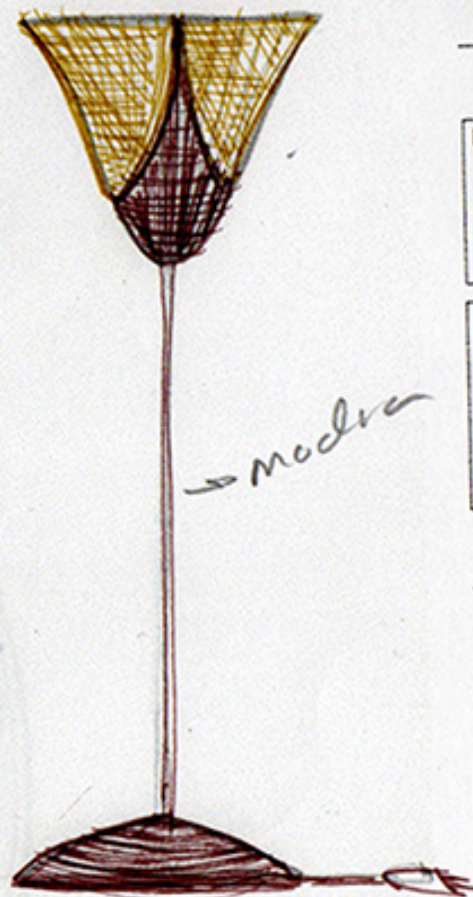

↓ madera

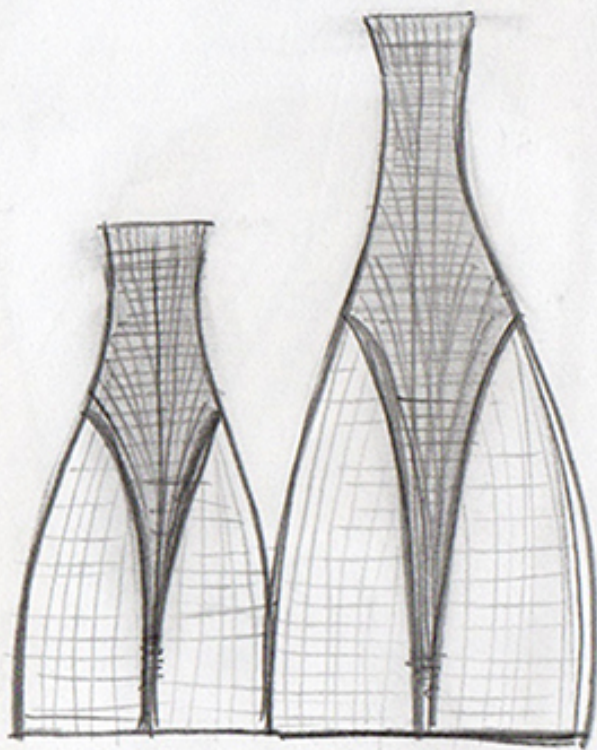
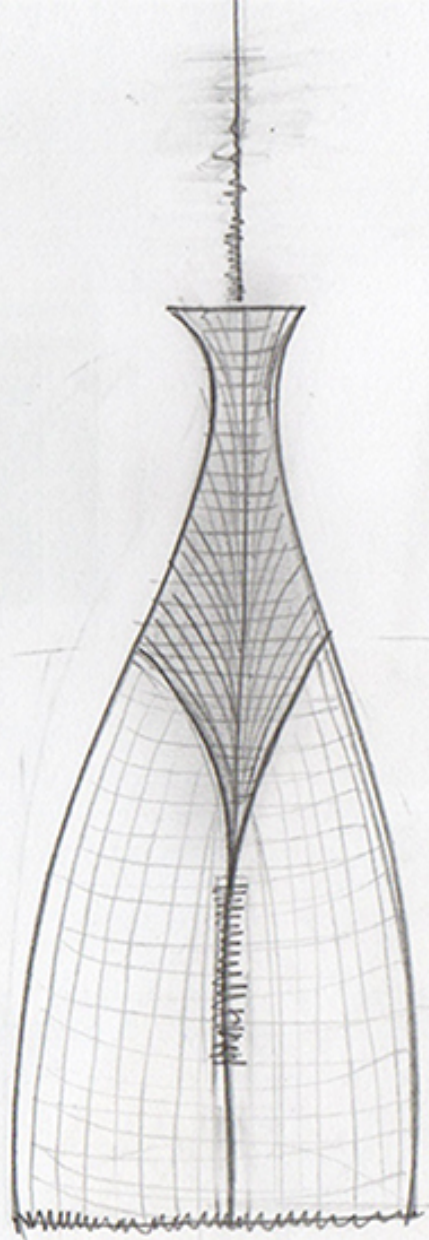

Laboratorio

Nidia

Línea

Pilolas

Producto

*Festival Internacional
de Manizales*

Pieza

12/1

Materias Primas

*Papel
alambre*

Paleta de Color



FIGURAS DECORATIVAS
REPRESENTATIVAS CON
REFERENTE DEL TEATRO
INTERNACIONAL DE MANIZALES
CARNAVAL DE RIOSUCIO

Costo

2014 sept

Fecha

Boceto 1 de 1

Referente





artesañas
de colombia

Ficha Técnica

Laboratorio

Línea

Bolso, Agenda

Producto

Cosmética

Pieza

Materias Primas

cuero
repujado

Paleta de Color



Costo

Sept/2014

Fecha

Boceto 1 de 1

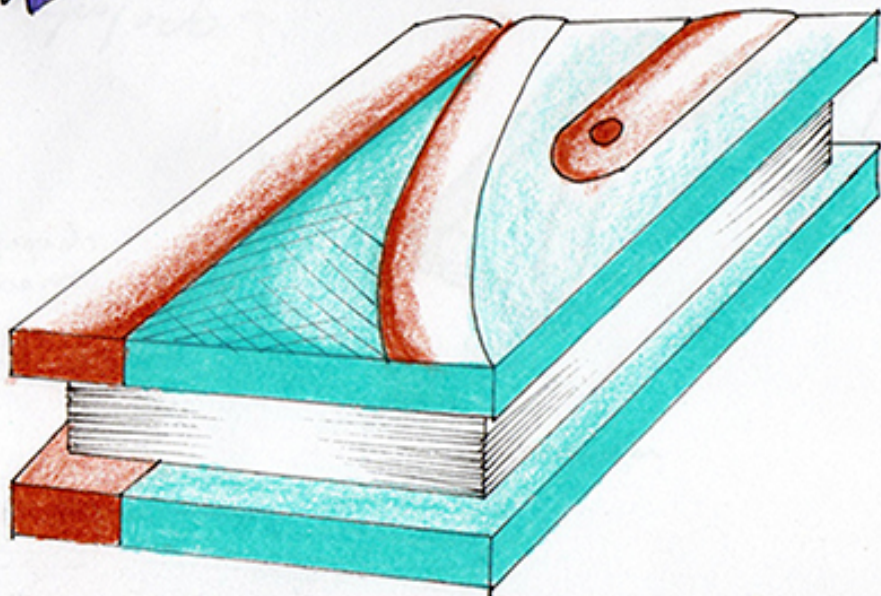
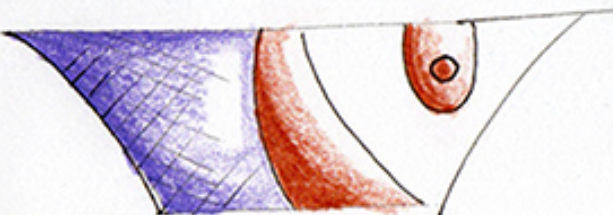
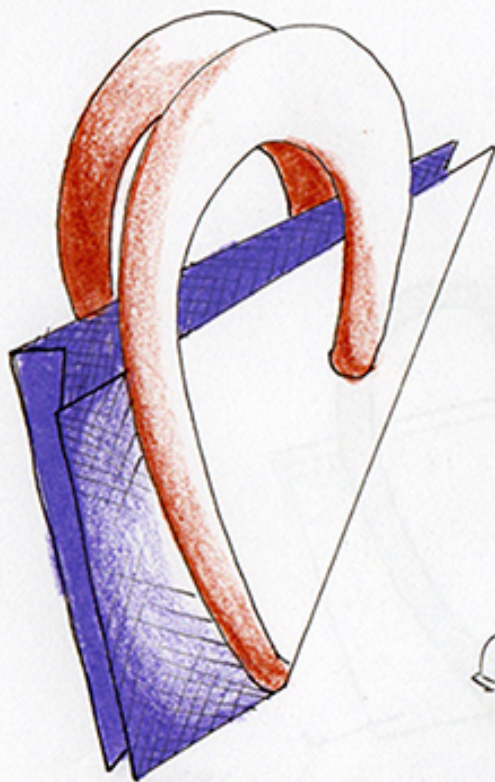

u!



artesanas de colombia

Ficha Técnica

Laboratorio

Línea
 Bolsos, Cosméticos
 Producto
 Agenda
 Pieza

Materias Primas
 Cuero

Paleta de Color

Costo
 \$1pt 2014
 Fecha

Boceto 1 de 1

Referente

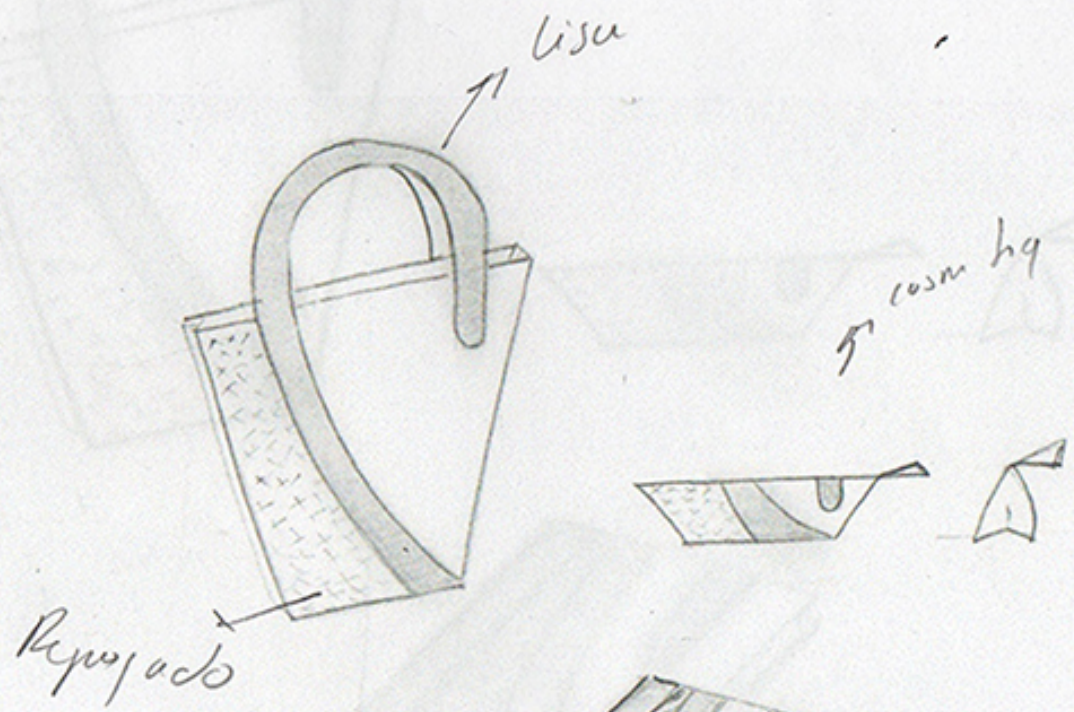

CX →
 Repujado
 Cuero.

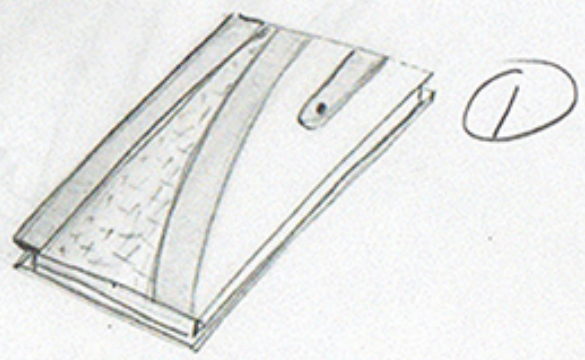

agenda

Referente



artesano
de Colombia

Ficha Técnica

Laboratorio

Línea

Bolso, femenino

Producto

Pieza

Materias Primas

Cuero
Repujado

Paleta de Color



Costo

Sept/2011

Fecha

Boceto 1 de 1

Laboratorio

Lumbi

Línea

Bolso, Monedero

Producto

Cosmética

Pieza

Materias Primas

*Cuero
Repujado*

Paleta de Color



Costo

sept 2014

Fecha

Boceto 1 de 1

Referente



①

liso

cositas

Repujado

Cuero





artesanía
de colombia

Ficha Técnica

Laboratorio

Línea

Bolso Cosmético

Producto

Bolso

Pieza

Materias Primas

*lana
lana*

Paleta de Color



Costo

Supt / 2014

Fecha

Boceto 1 de 1

Referente

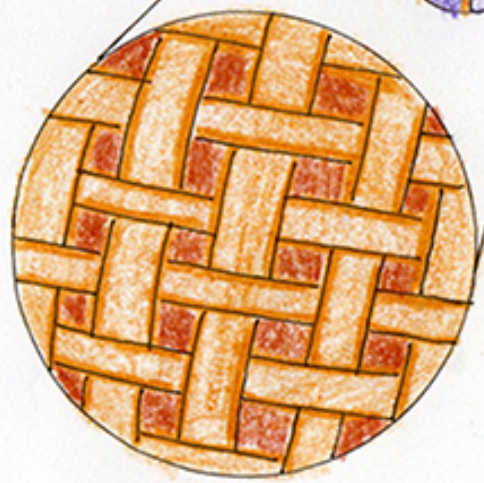
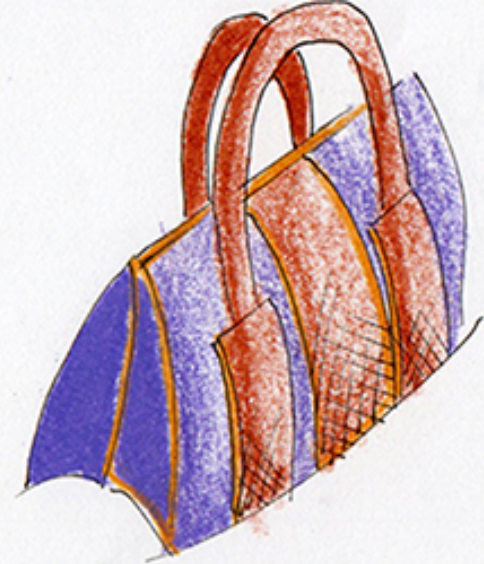

M?

Bolsos, Cosméticos
Producto

Cuero
Repujado

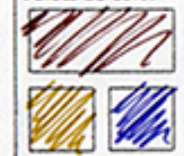

Sept 2014
Fecha

Referente



①

Repujado tejido

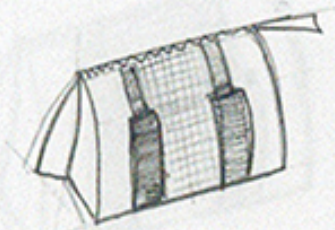
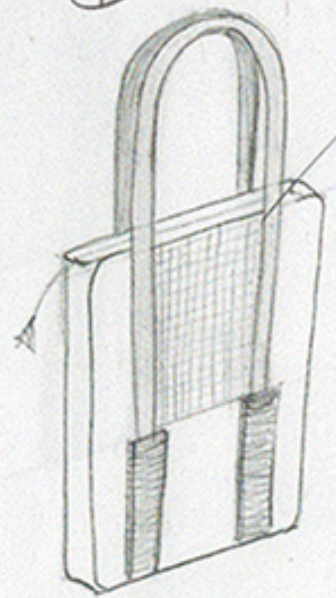

cosmética

tejido
Repujado

tejido
Repujado



artesanas
de colombia

Ficha Técnica

Laboratorio

Línea

Cinruron

Producto

Caminosafes u

Pieza

porrevasus

Materias Primas

Molclera
Hiles

Paleta de Color



Costo

Sept/2014

Fecha

Boceto 1 de 1

Referente

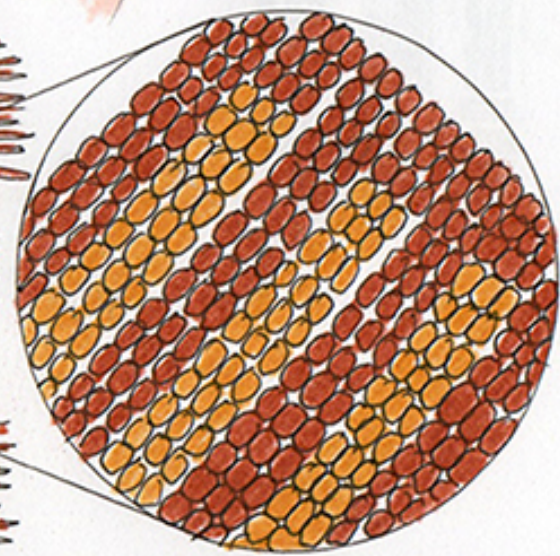
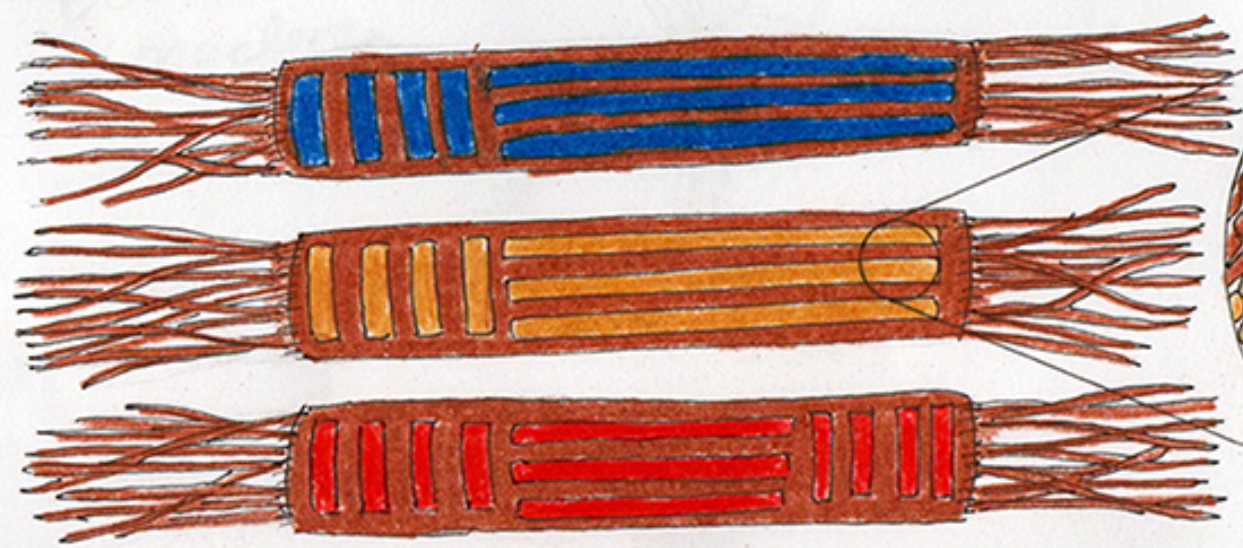
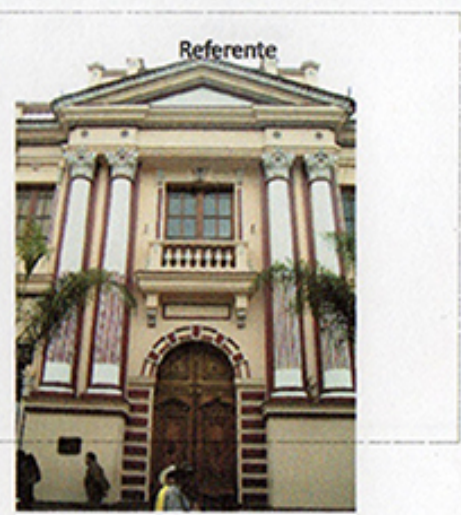



artesanía
de colombia

Ficha Técnica

Laboratorio

Republicana

Línea

Collar, cintura

Producto

Pieza

Materias Primas

Hilos
Maderas

Paleta de Color

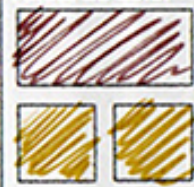

Costo

sept 2014

Fecha

Boceto 1 de 1

Referente

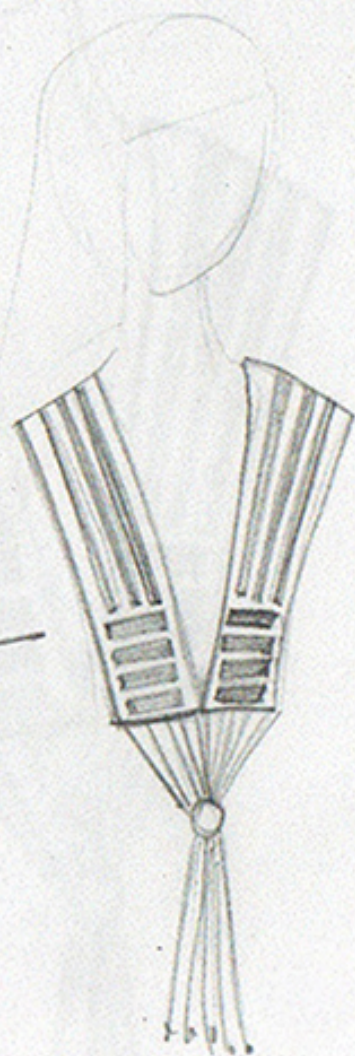

①
Bolutas de
madera
tejidas.

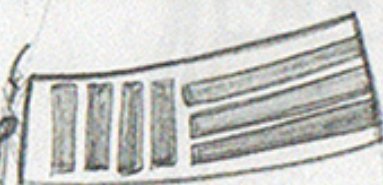

Palacio
Artístico

Referente

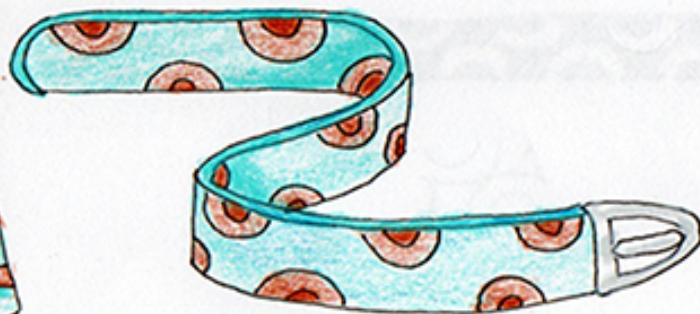
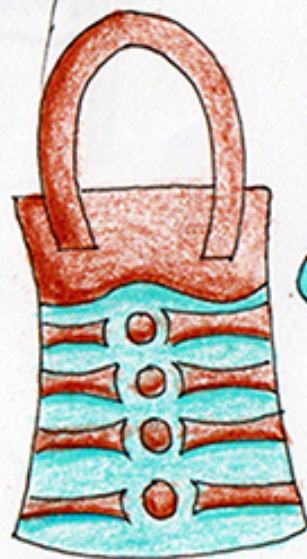
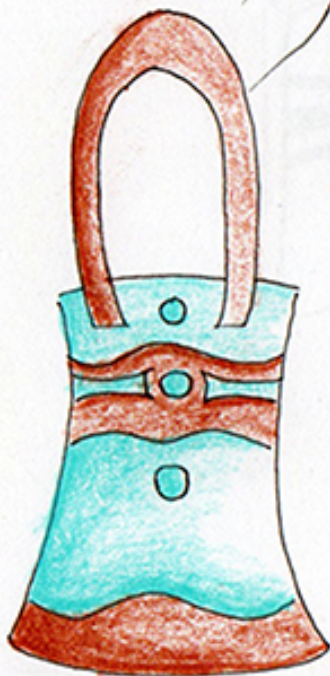
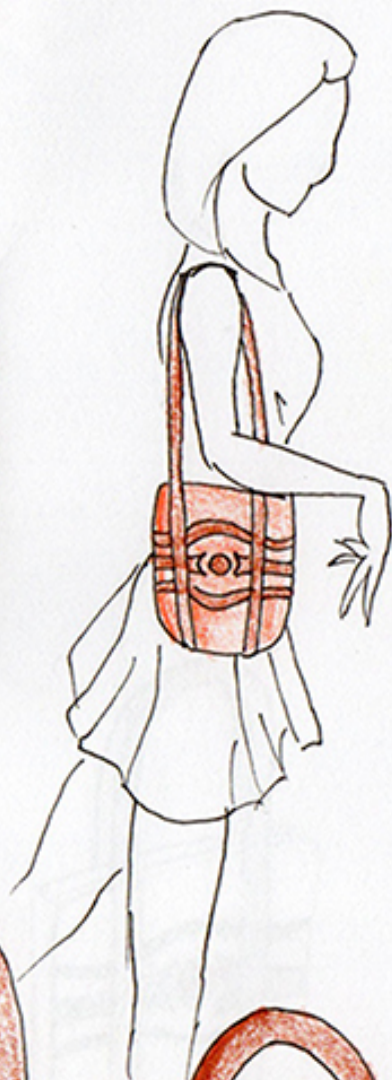

artesanas
de colombia

Ficha Técnica

Laboratorio

Línea

Bolsos, cinturón

Producto

Pieza

Materias Primas

*Cuero
Repujado*

Paleta de Color



Costo

Sept/2014

Fecha

Boceto 1 de 1

Laboratorio

Arquitectura Area

Línea

Bolso, como

Producto

Pieza

Materias Primas

cuero

Paleta de Color



4

Costo

Sept 2014

Fecha

Boceto 1 de 1

Referente

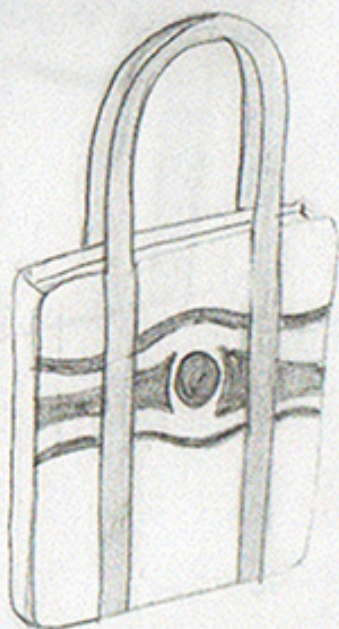

cuero

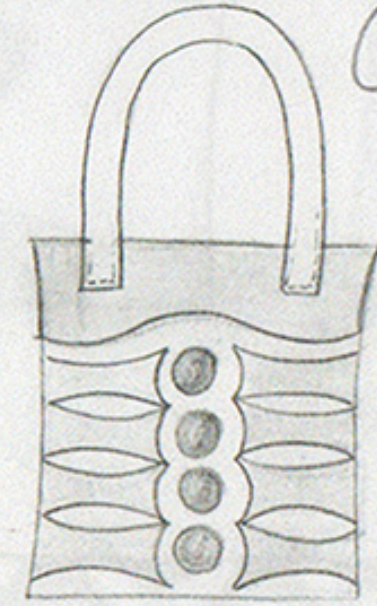
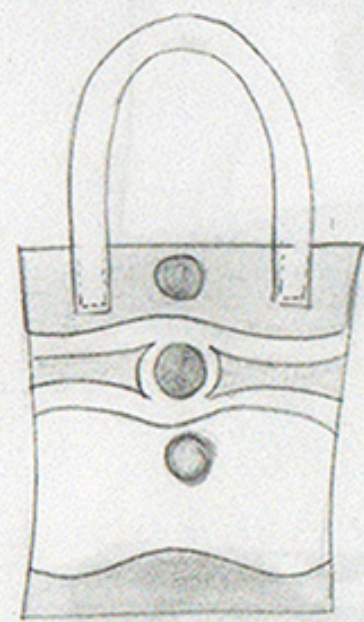

1





artesañas
de colombia

Ficha Técnica

Laboratorio

JUGUETERÍA

Línea

LASOS

Producto

Pieza

Materias Primas

MADERA E
HILO ENTORCHADO

Paleta de Color



Costo

SEPT 2014

Fecha

Boceto 1 de 1

Referente

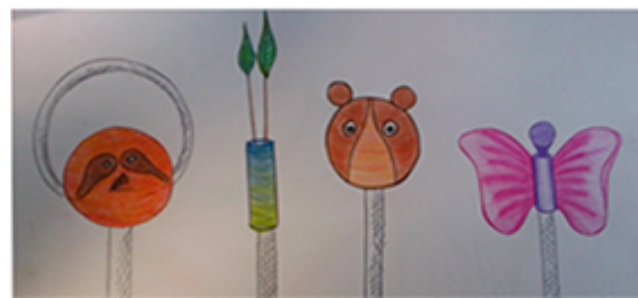



artesañas
de colombia

Ficha Técnica

Laboratorio

JUGUETERÍA

Línea

BALEROS

Producto

Pieza

Materias Primas

MADERA E

Paleta de Color



Costo

SEPT 2014

Fecha

Boceto 1 de 1

Referente

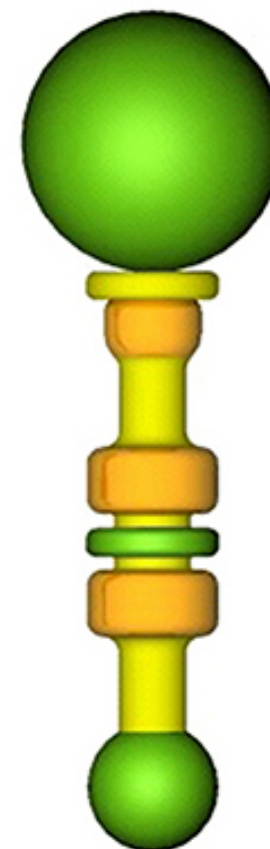
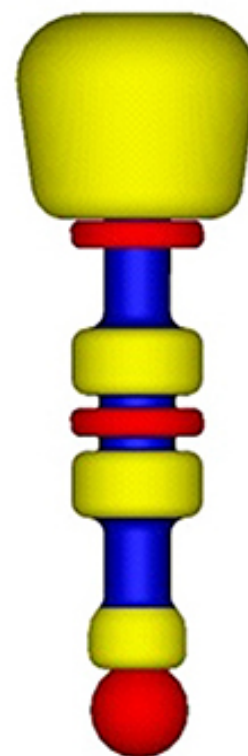
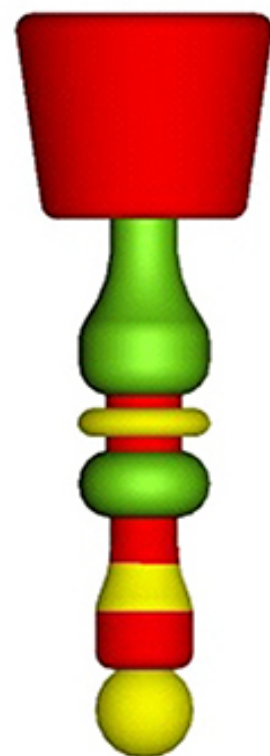



artesañas
de colombia

Ficha Técnica

Laboratorio

JUGUETERÍA

Línea

BALEROS

Producto

Pieza

Materias Primas

MADERA

Paleta de Color



Costo

SEPT 2014

Fecha

Boceto 1 de 1

Referente

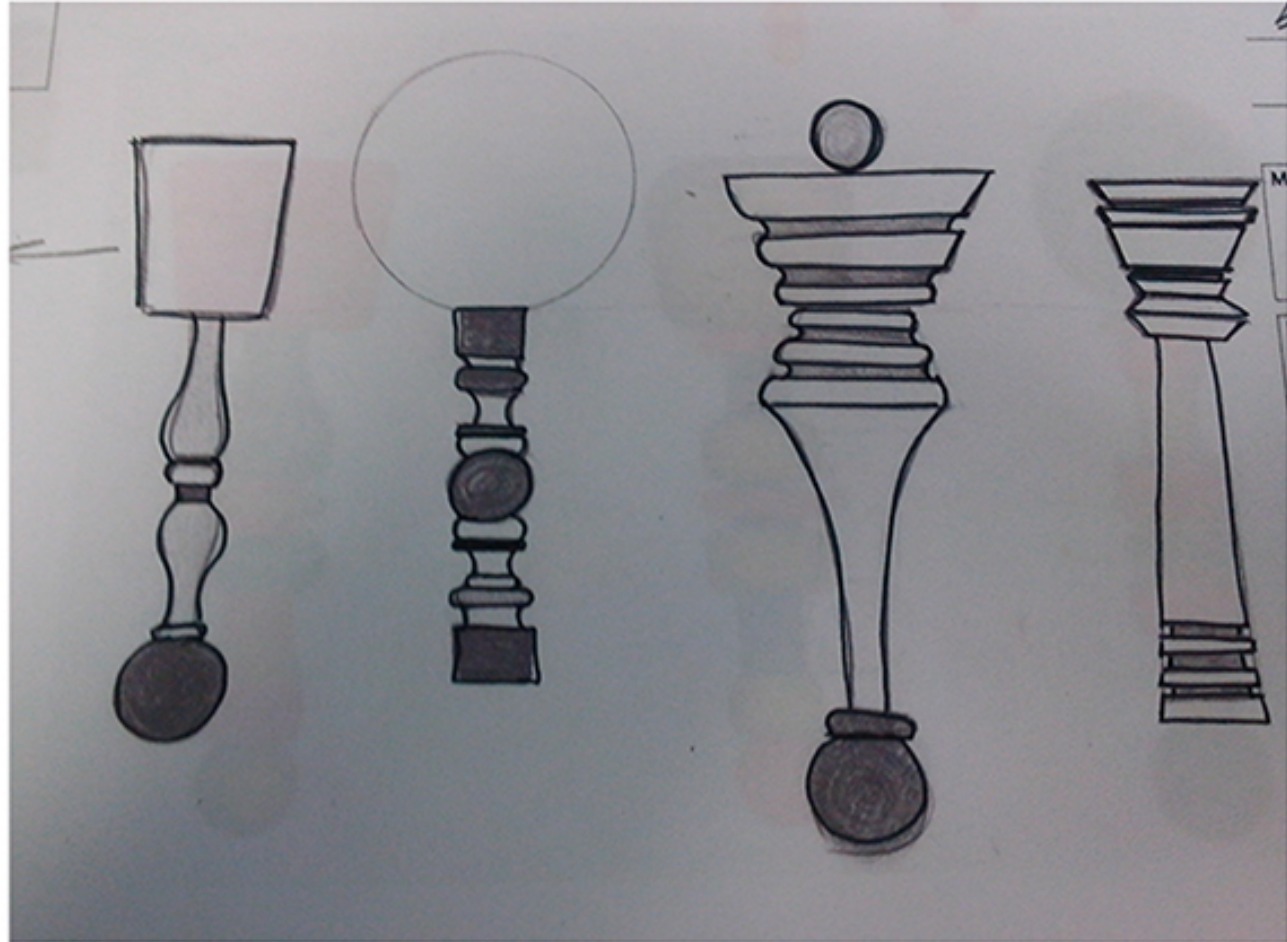



artesañas
de colombia

Ficha Técnica

Laboratorio

JOYERÍA

Línea

DIJE, COLLAR Y ARETE
Producto

Pieza

Materias Primas

PLATA
PIRITA

Paleta de Color



Costo

SEPT 2014

Fecha

Boceto 1 de 1

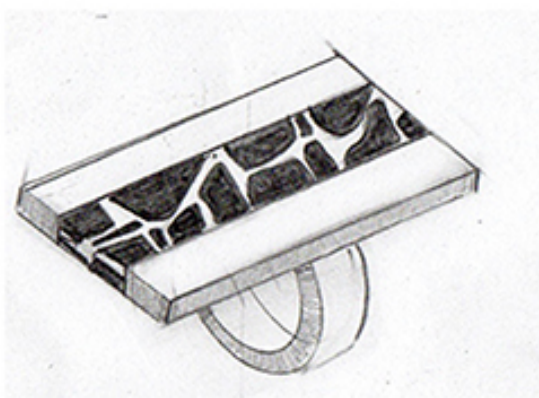
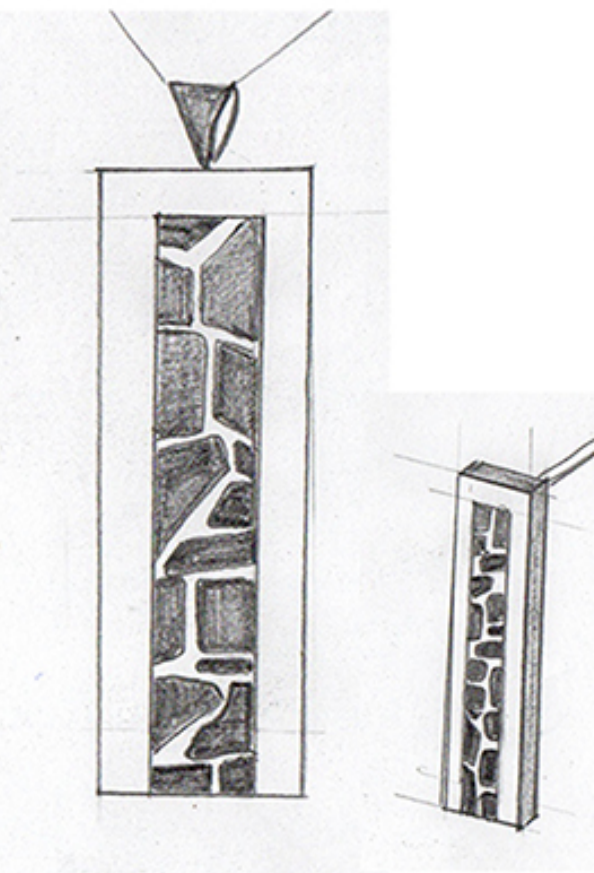
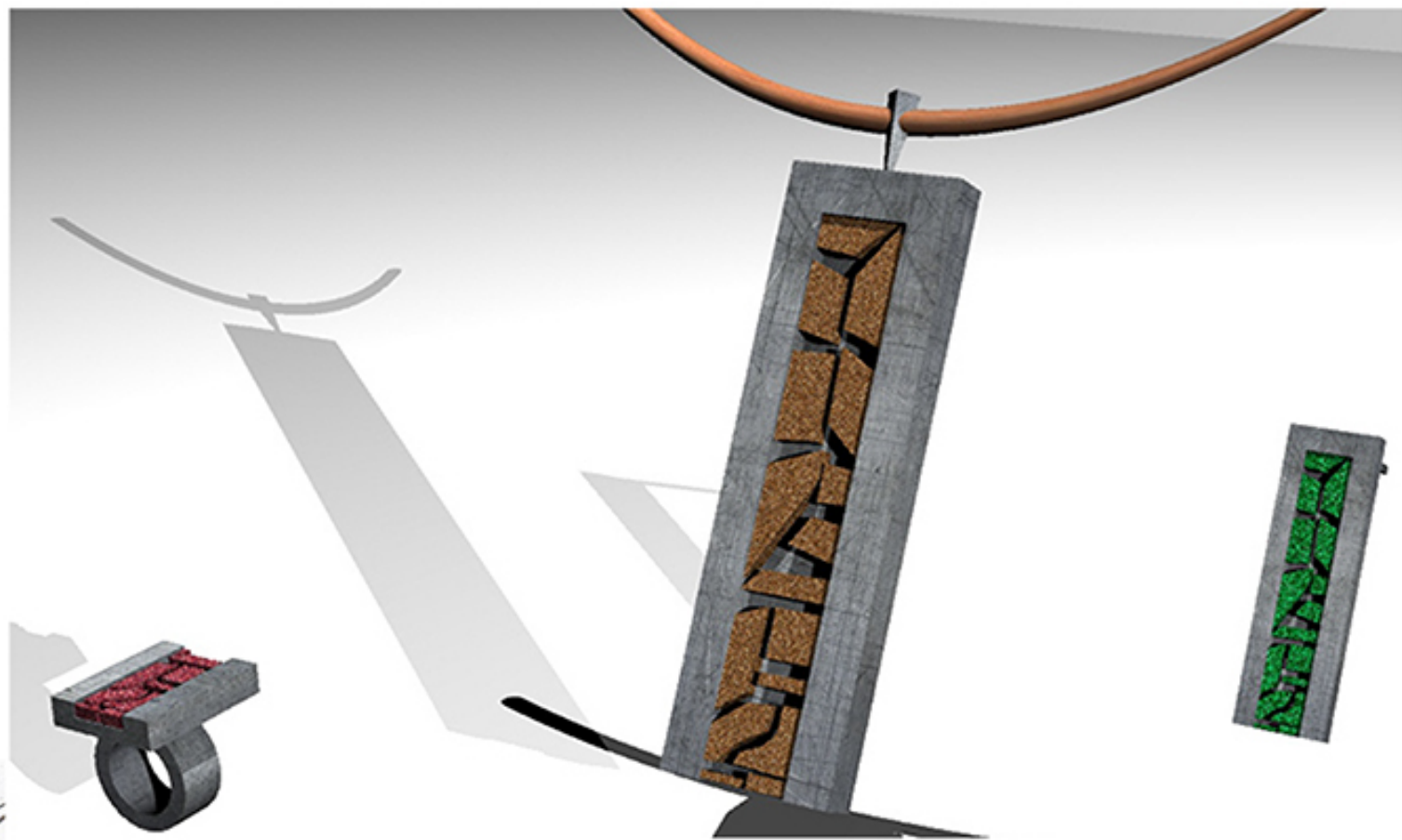



artesañas
de colombia

Ficha Técnica

Laboratorio

JOYERÍA

Línea

ARETE

Producto

Pieza

Materias Primas

PLATA
PIRITA

Paleta de Color



Costo

SEPT 2014

Fecha

Boceto 1 de 1

Referente





artesañas
de colombia

Ficha Técnica

Laboratorio

JOYERÍA

Línea

DIJE

Producto

Pieza

Materias Primas

PLATA
PIRITA

Paleta de Color



Costo

SEPT 2014

Fecha

Boceto 1 de 1

Referente





artesañas
de colombia

Ficha Técnica

Laboratorio

JOYERÍA

Línea

ANILLOS

Producto

Pieza

Materias Primas

PLATA
PIRITA

Paleta de Color



Costo

SEPT 2014

Fecha

Boceto 1 de 1

Referente





artesañas
de colombia

Ficha Técnica

Laboratorio

JOYERÍA

Línea

DIJE, COLLAR Y ARETE
Producto

Pieza

Materias Primas

PLATA
PIRITA

Paleta de Color



Costo

SEPT 2014

Fecha

Boceto 1 de 1

Referente

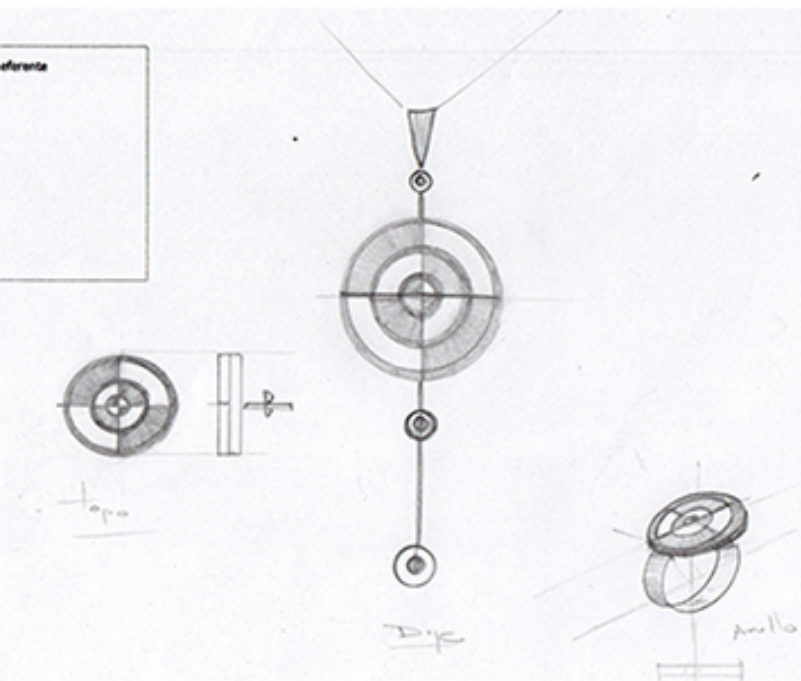
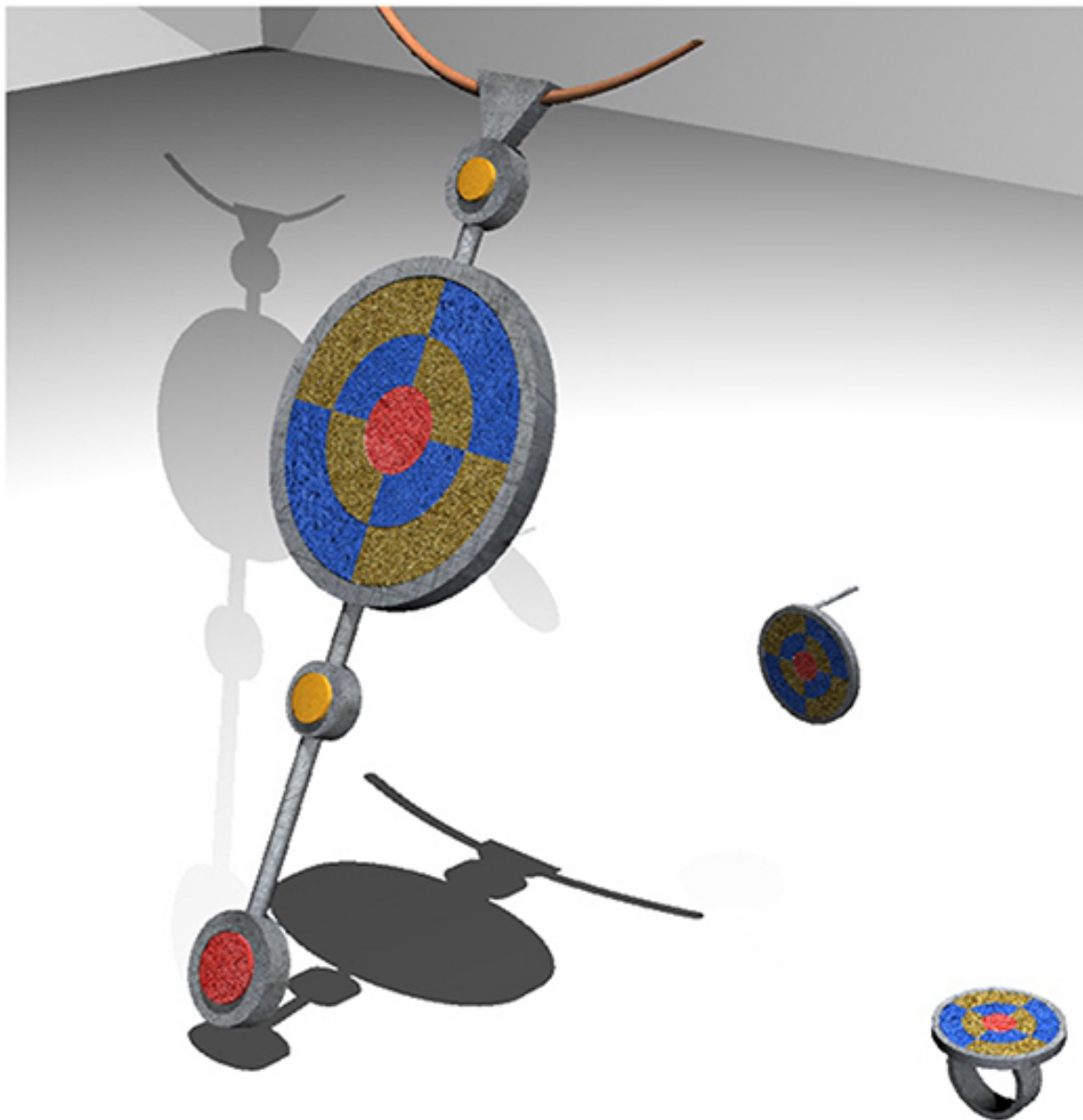



artesañas
de colombia

Ficha Técnica

Laboratorio

JOYERÍA

Línea

DIJES, ANILLO
Producto

Pieza

Materias Primas

PLATA
PIRITA

Paleta de Color



Costo

SEPT 2014

Fecha

Boceto 1 de 1

Referente

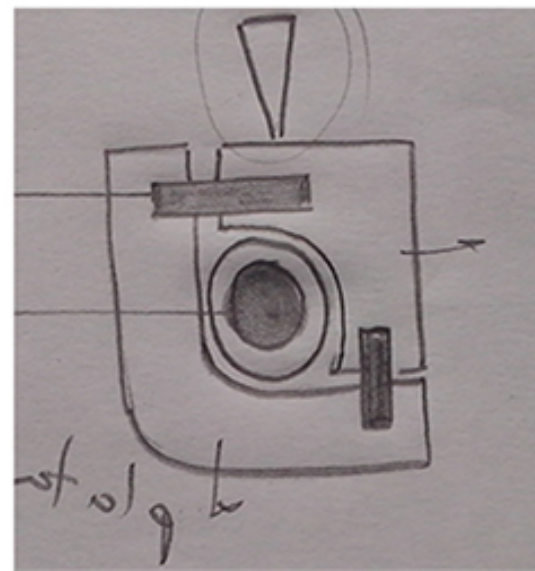
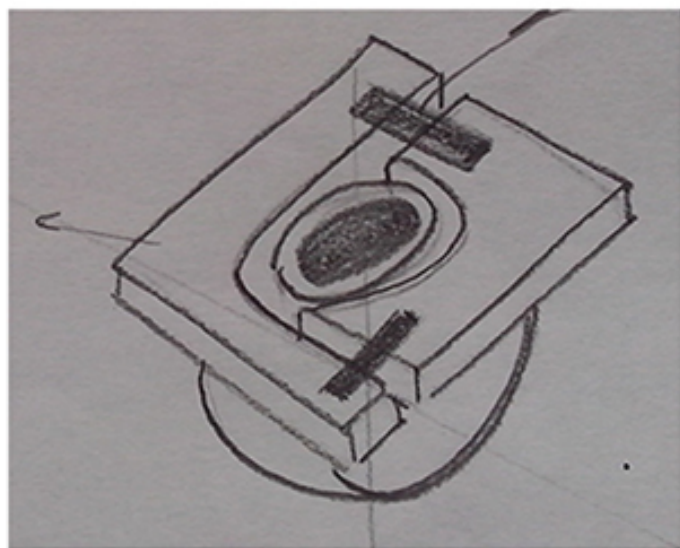
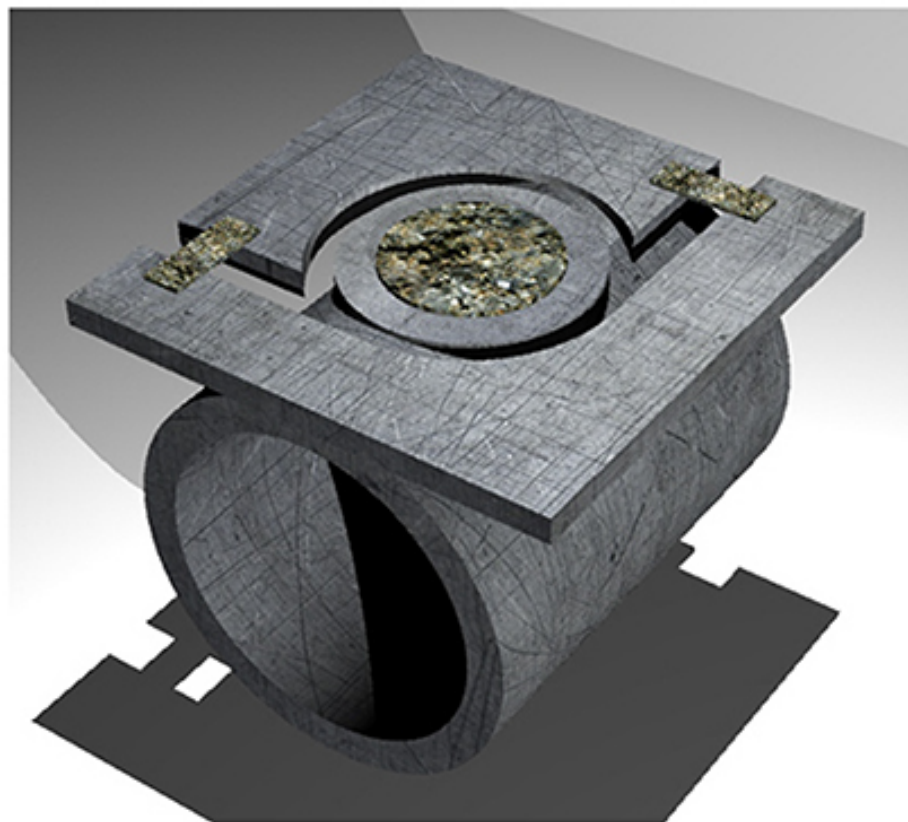



artesañas
de colombia

Ficha Técnica

Laboratorio

JOYERÍA

Línea

DIJES,

Producto

Pieza

Materias Primas

PLATA
PIRITA

Paleta de Color



Costo

SEPT 2014

Fecha

Boceto 1 de 1

Referente

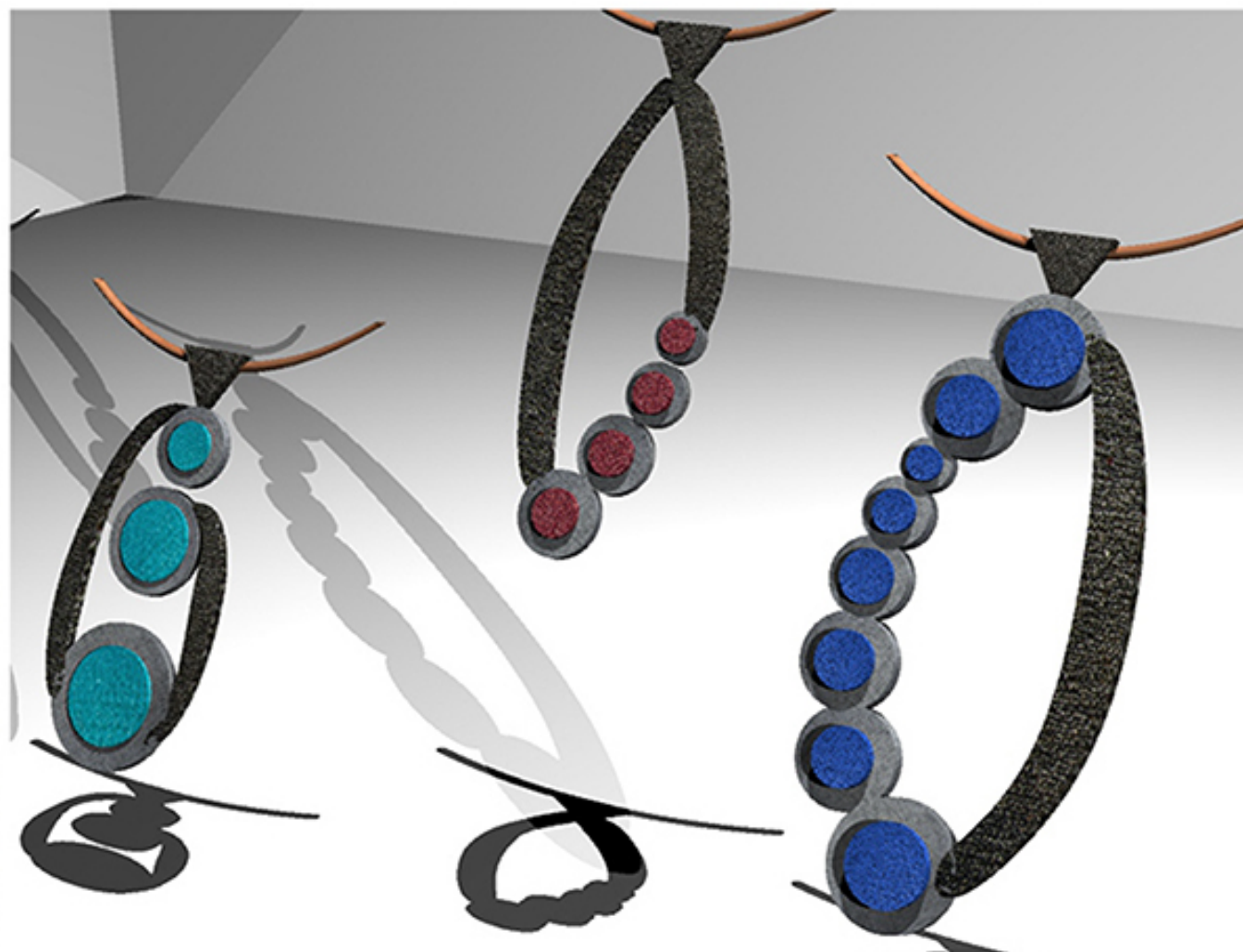
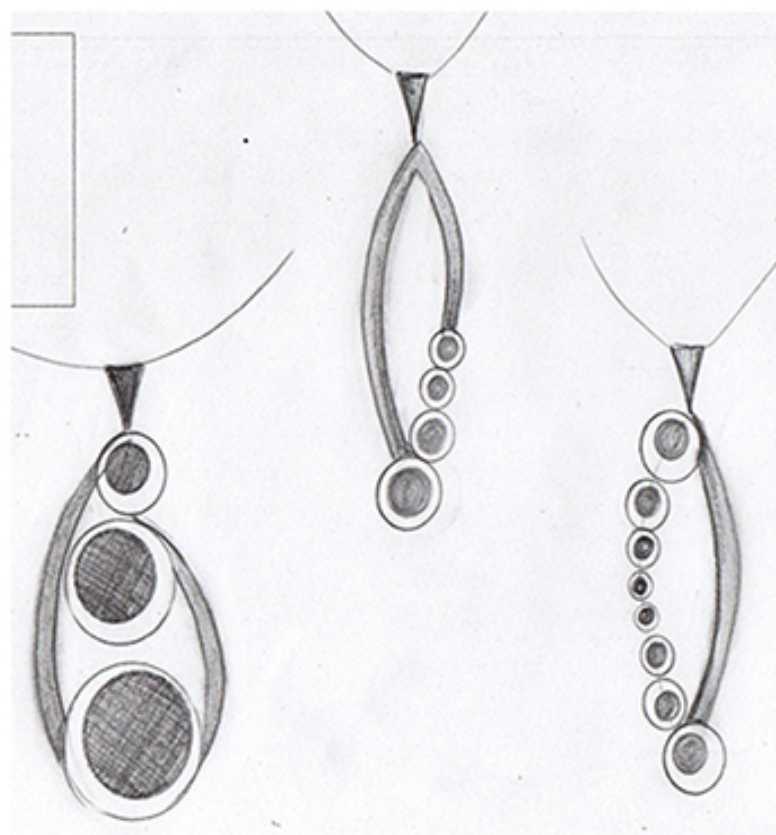



artesañas
de colombia

Ficha Técnica

Laboratorio

JOYERÍA

Línea

DIJES,

Producto

Pieza

Materias Primas

PLATA
PIRITA

Paleta de Color



Costo

SEPT 2014

Fecha

Boceto 1 de 1

Referente

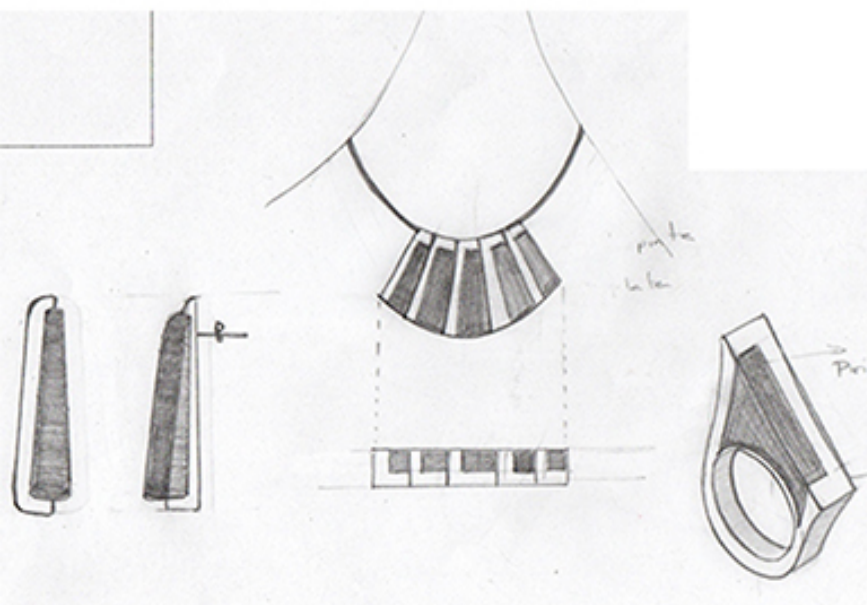
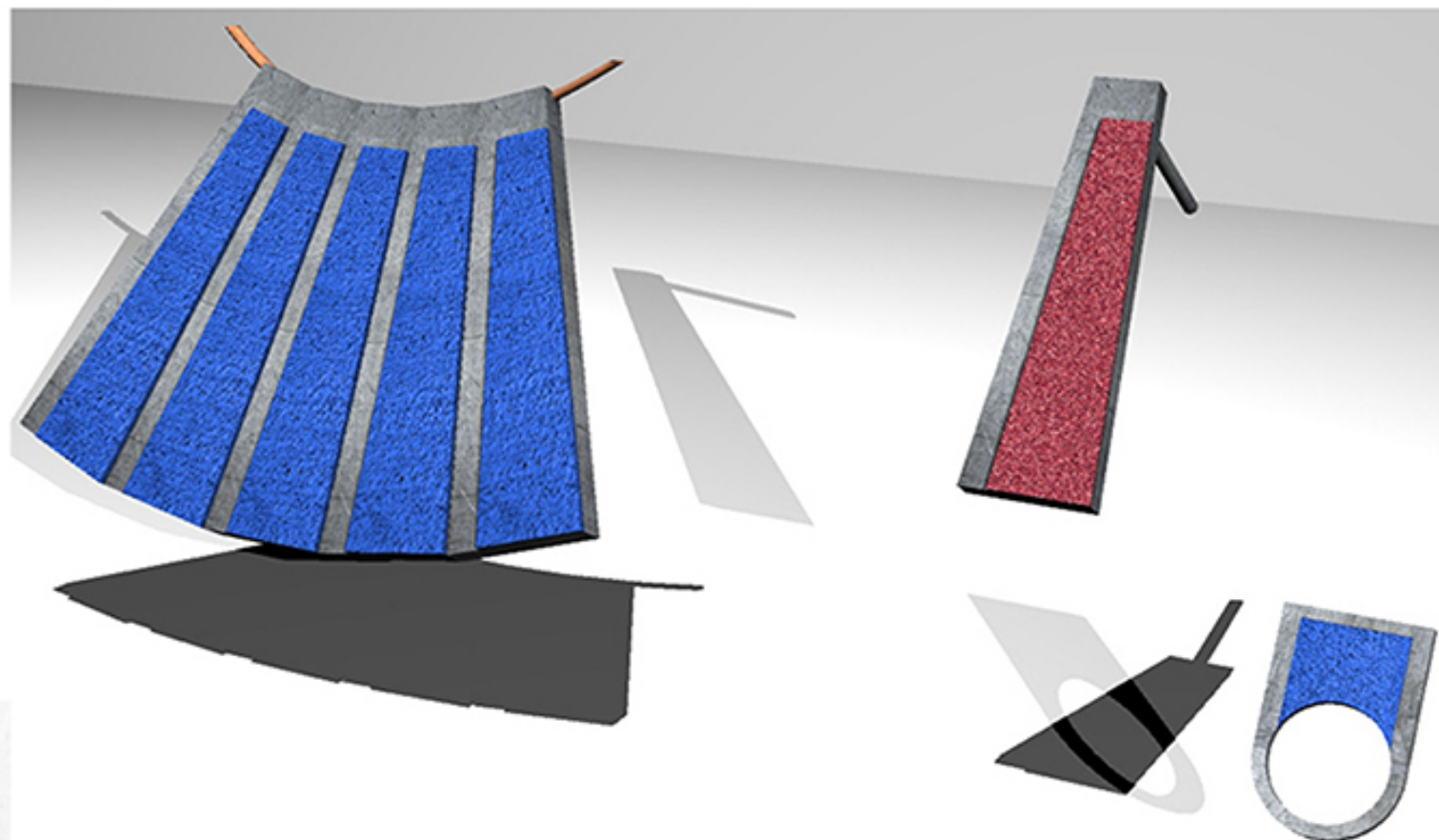



artesañas
de colombia

Ficha Técnica

Laboratorio

JOYERÍA

Línea

DIJES,, COLLAR, ARETES

Producto

Pieza

Materias Primas

PLATA
PIRITA

Paleta de Color



Costo

SEPT 2014

Fecha

Boceto 1 de 1

Referente

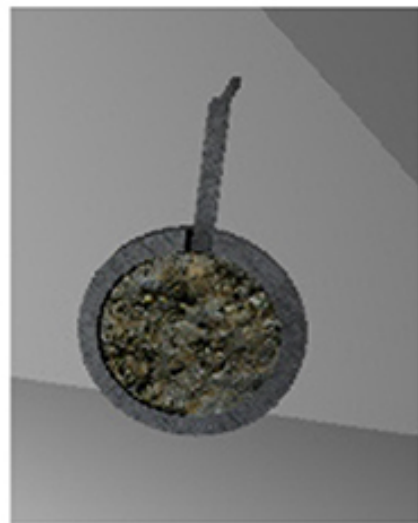
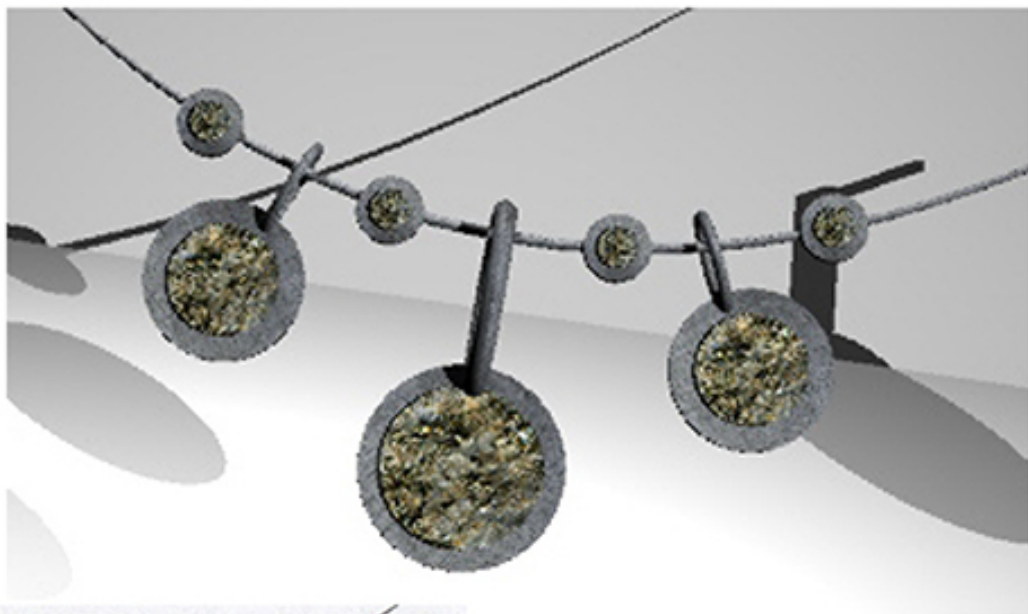

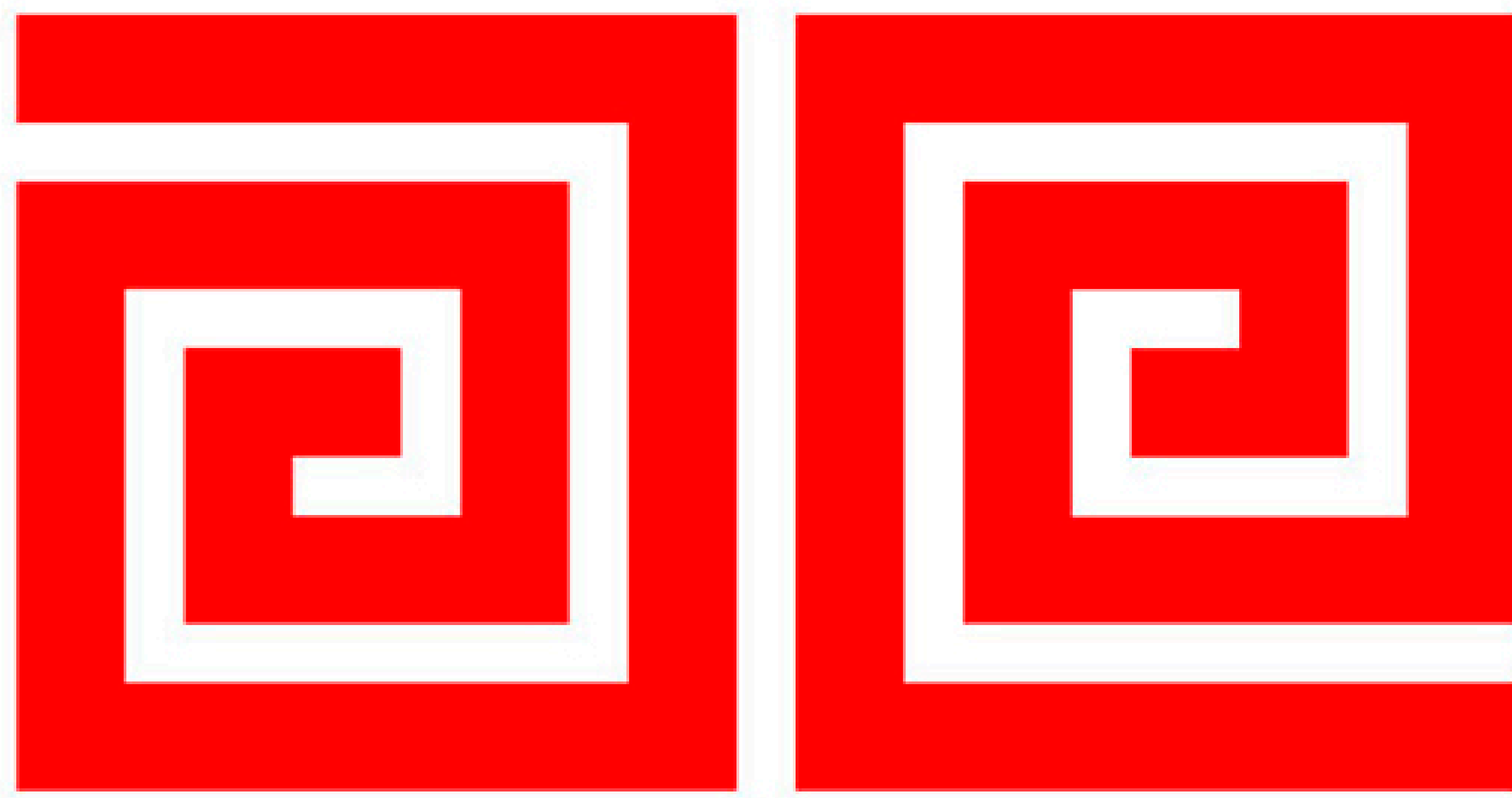

Ministerio de Comercio, Industria y Turismo
artesanías de colombia s.a.

Programa “Ampliación de la cobertura geográfica y poblacional”

Proyecto “fortalecimiento económico y comercial de las vocaciones productivas artesanales en el departamento de Caldas

[Registro fotográfico de capacitación en diseño y de ejercicios de de elementos de decoración de para productos de innovación]











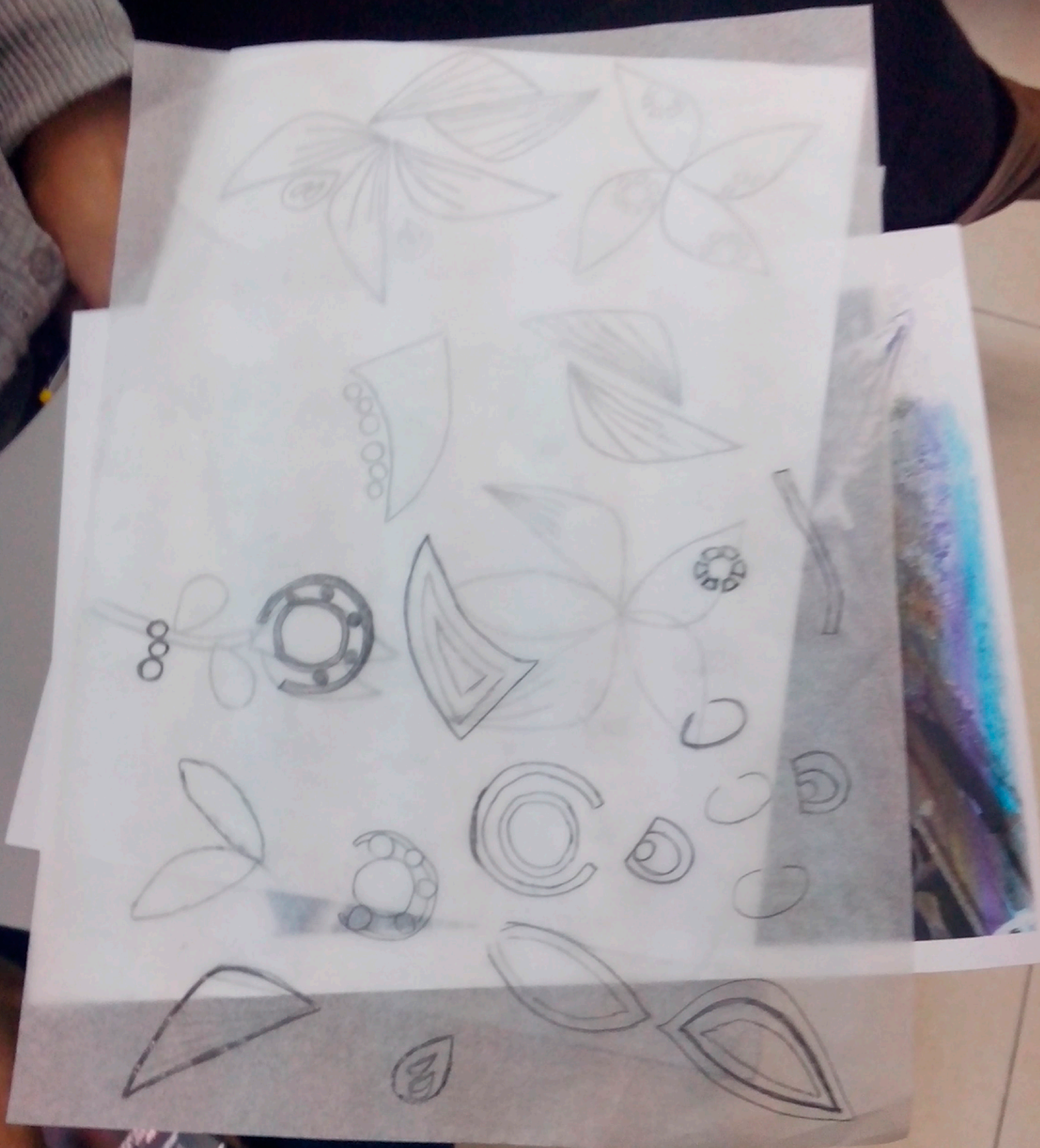

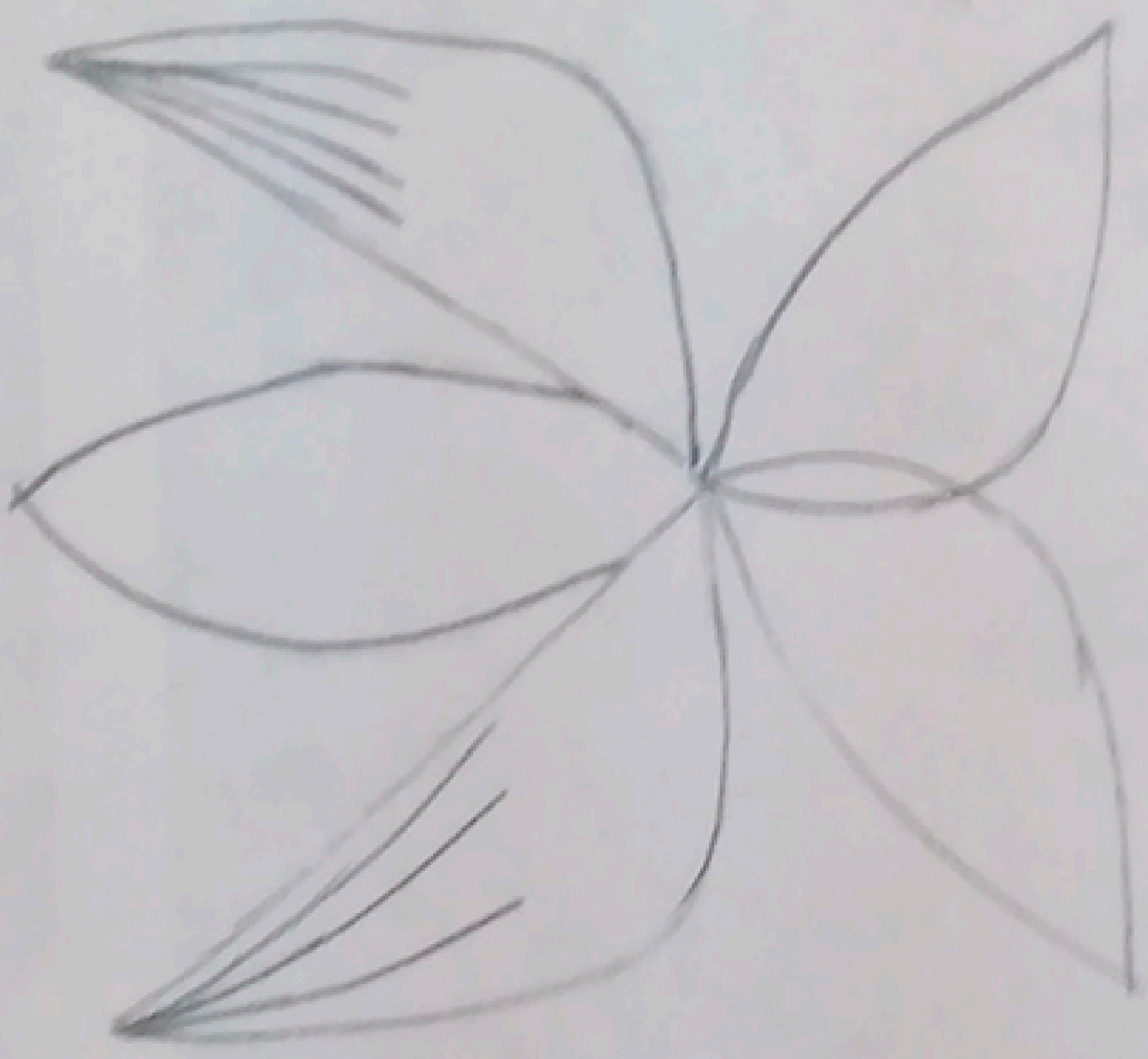
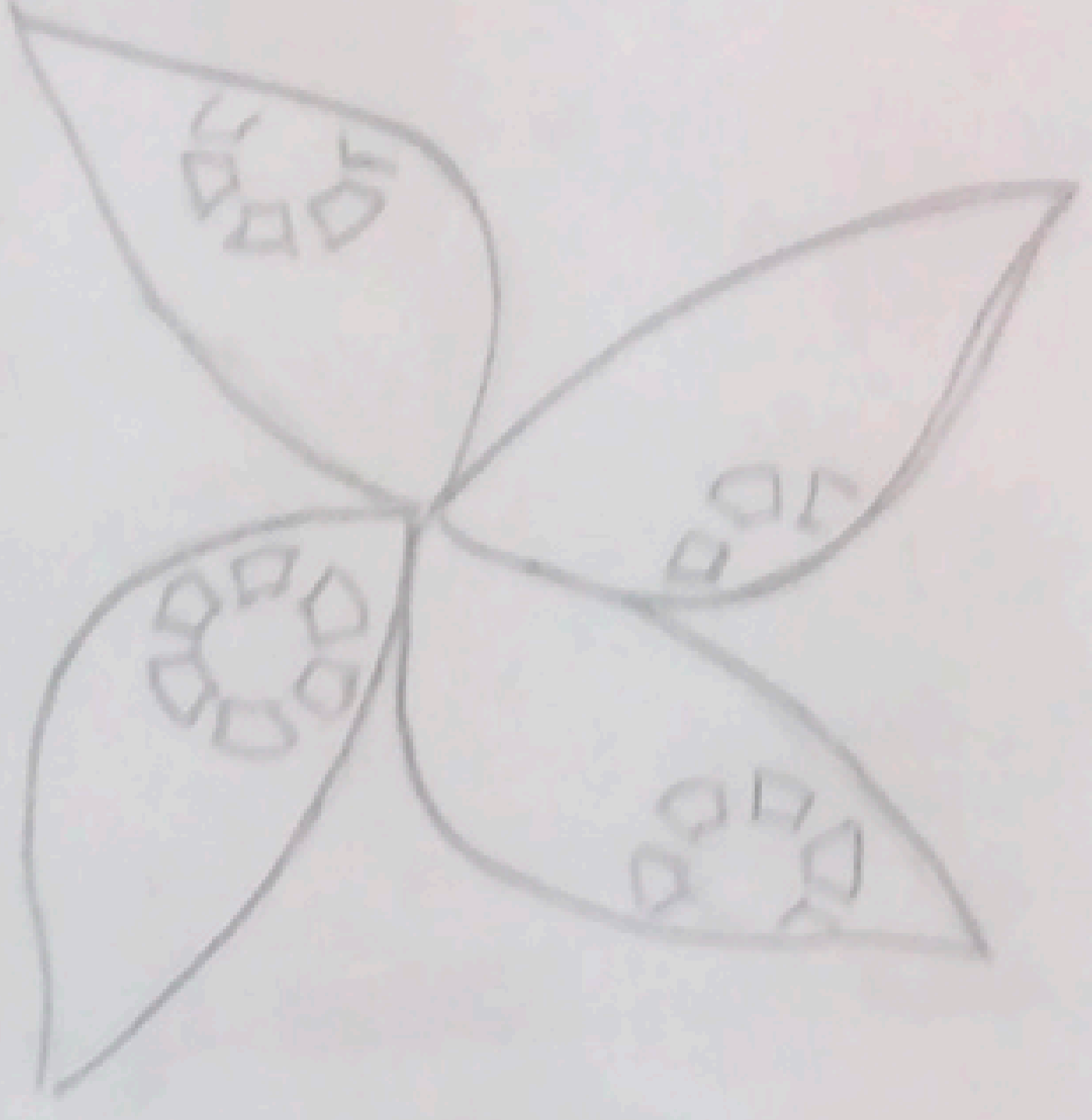
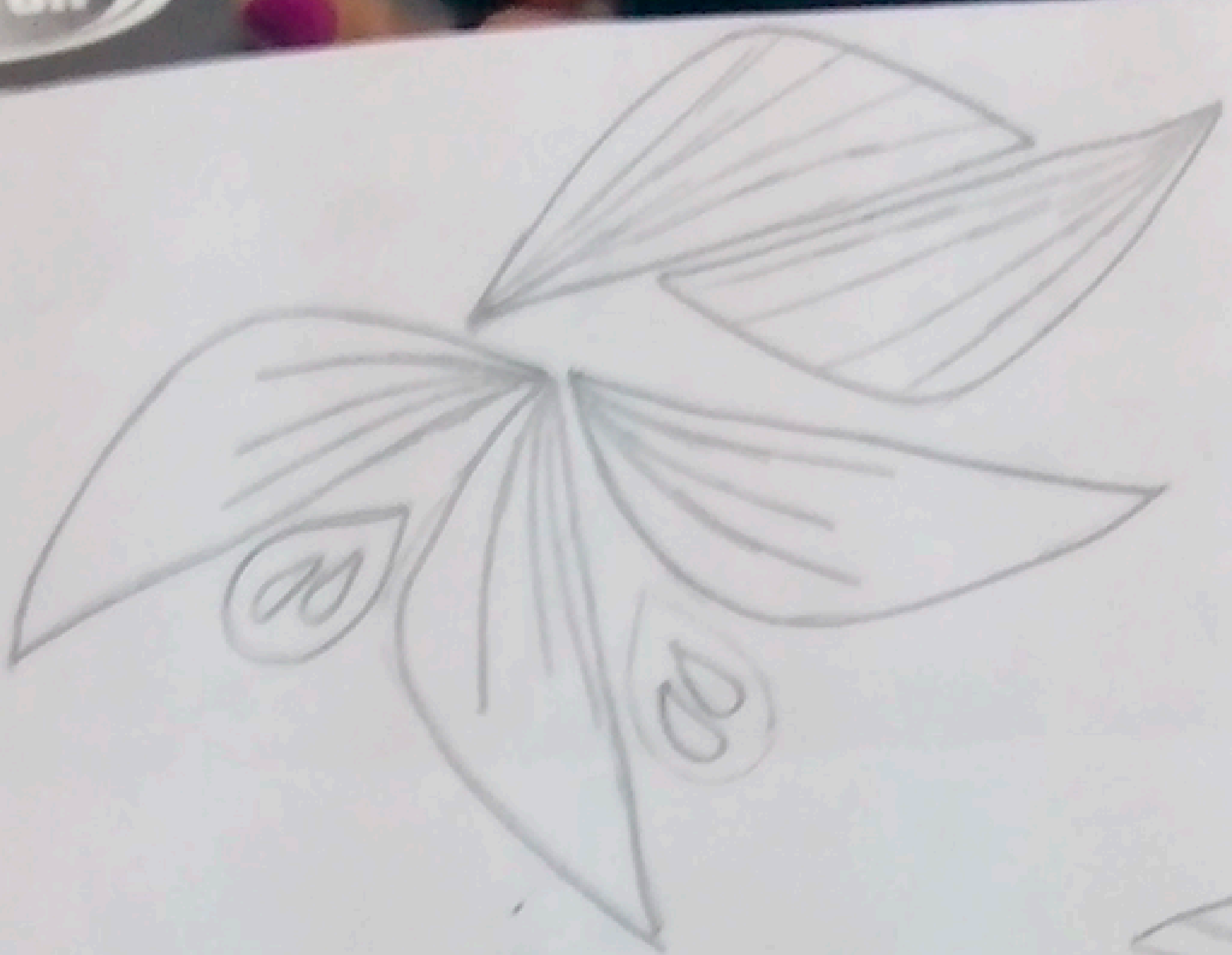



88

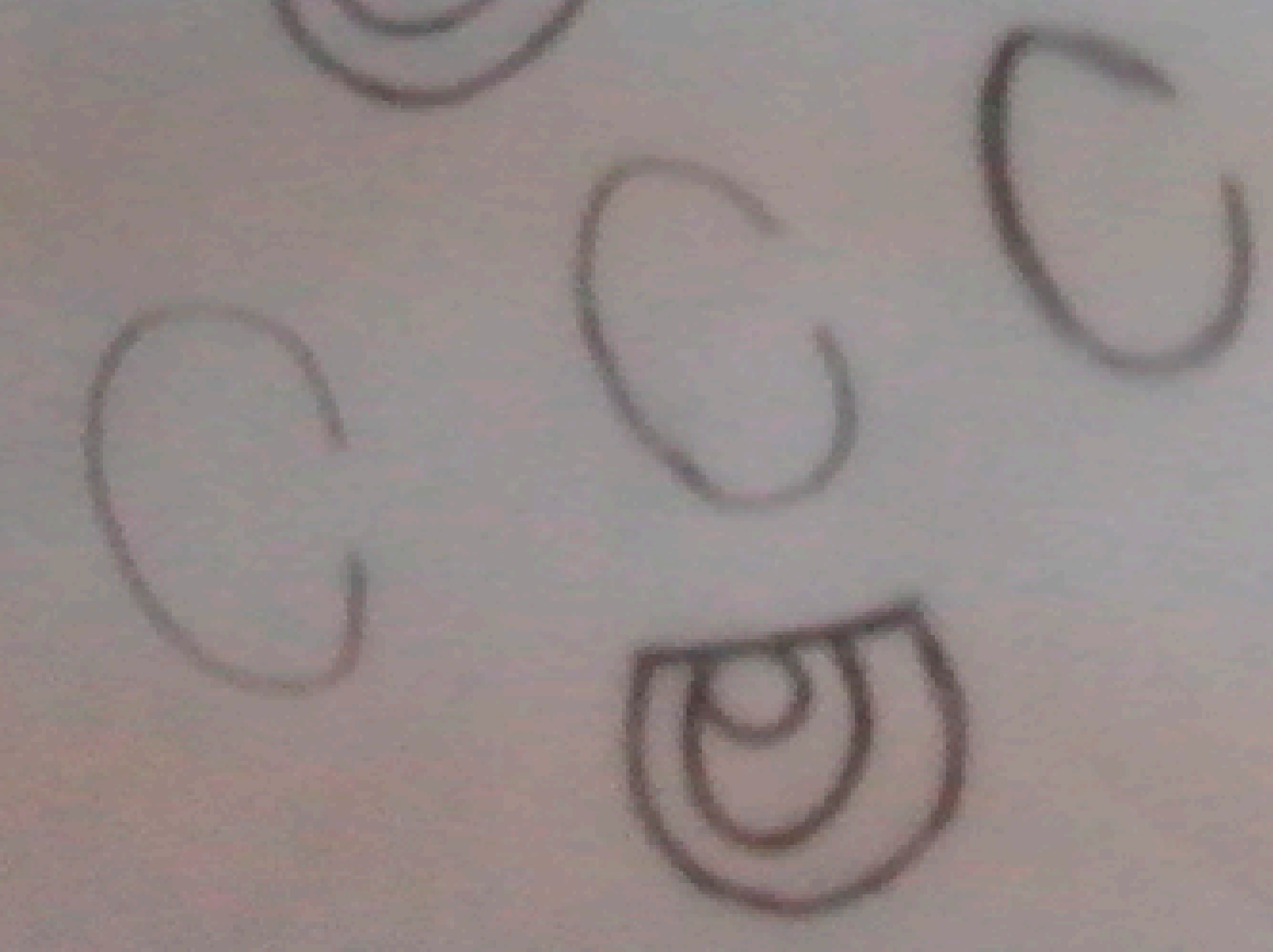

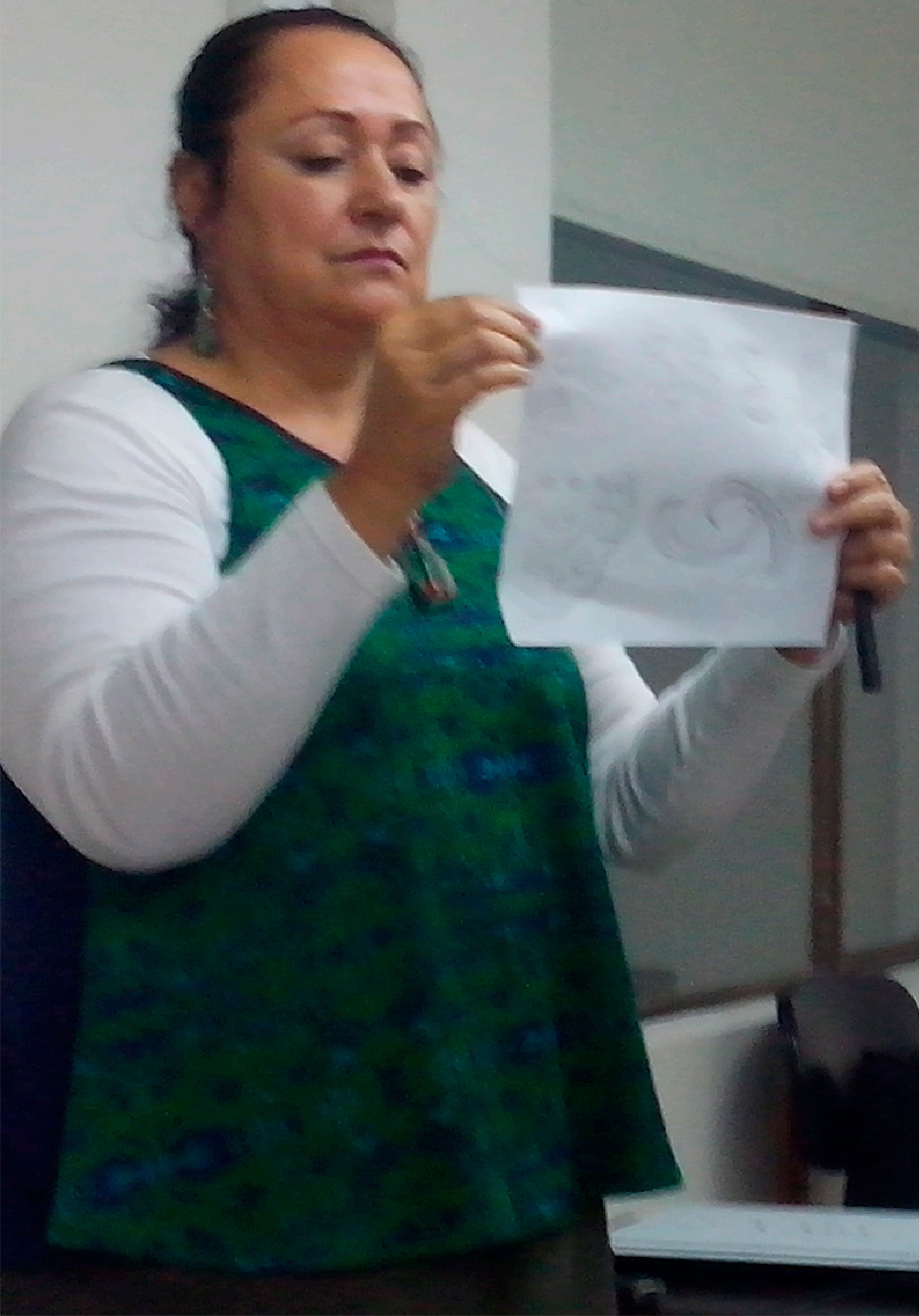

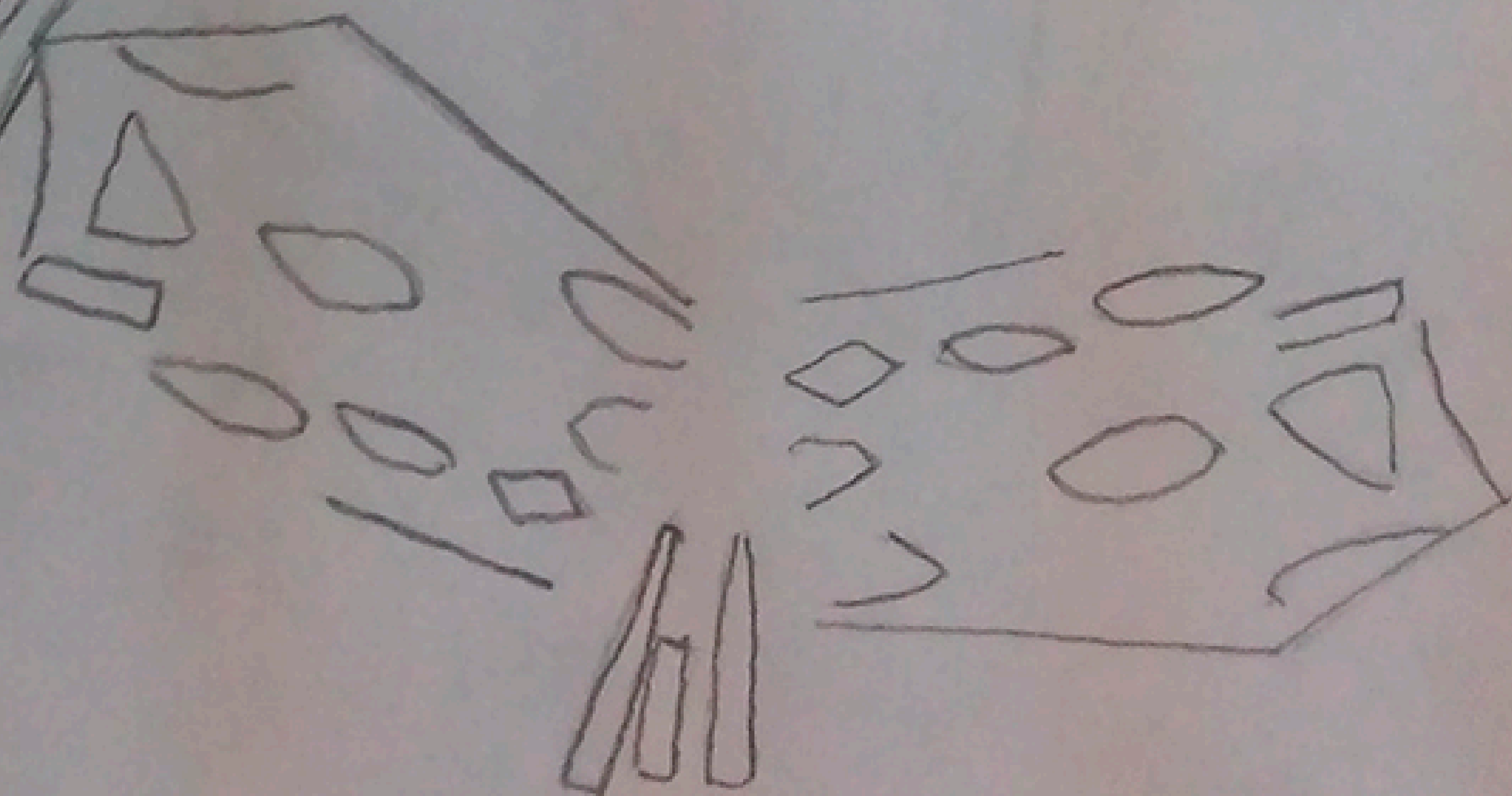
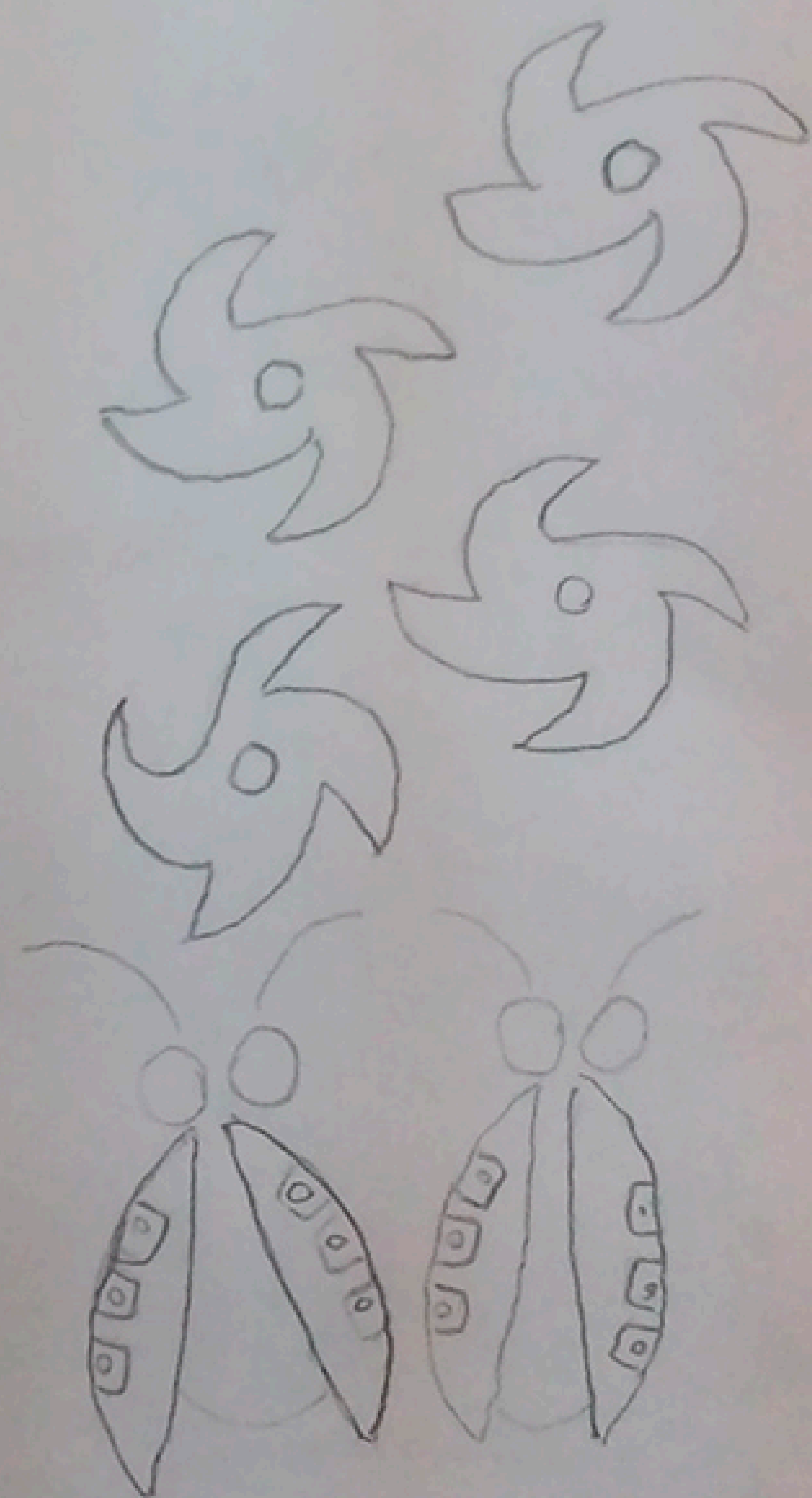
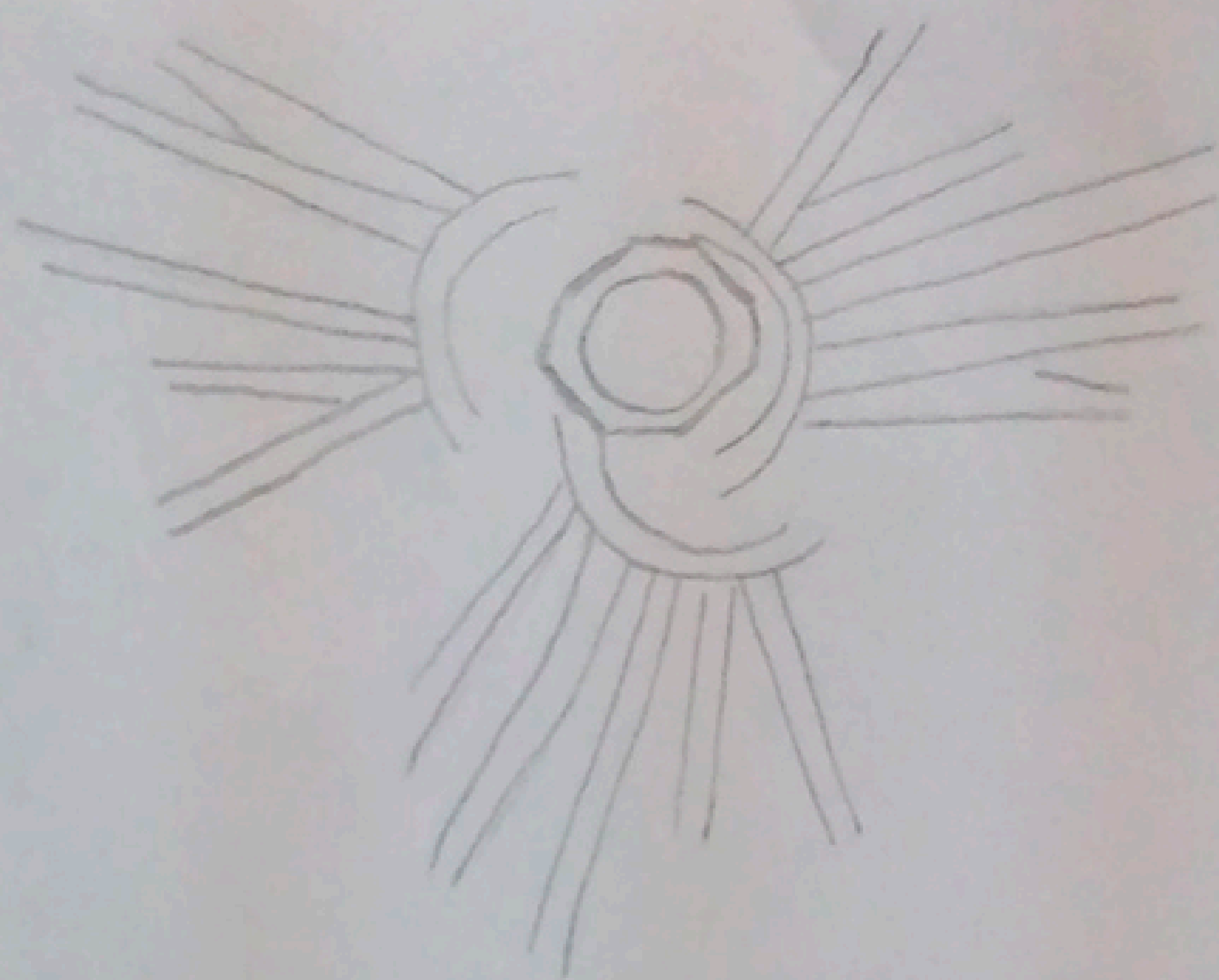
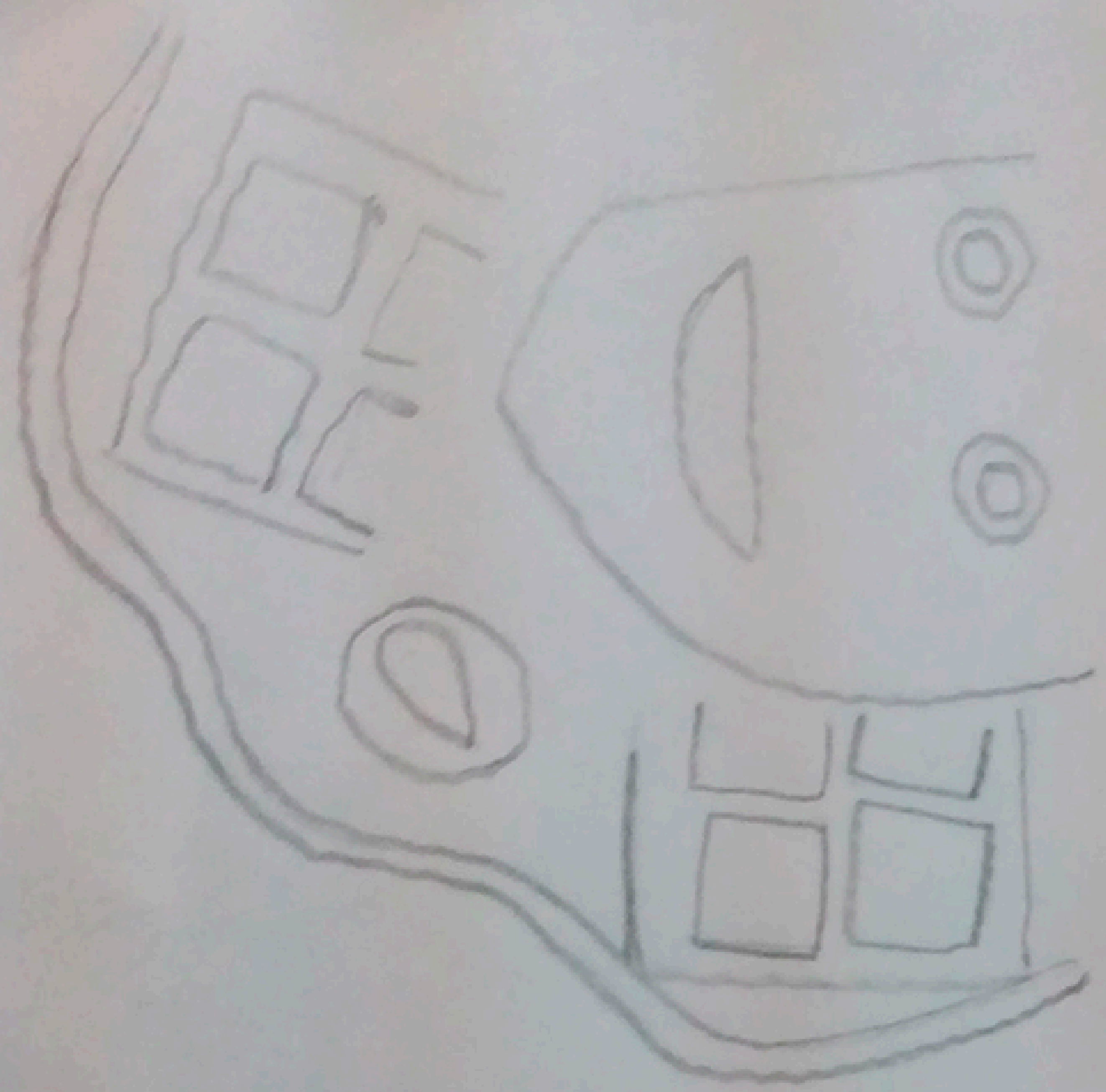

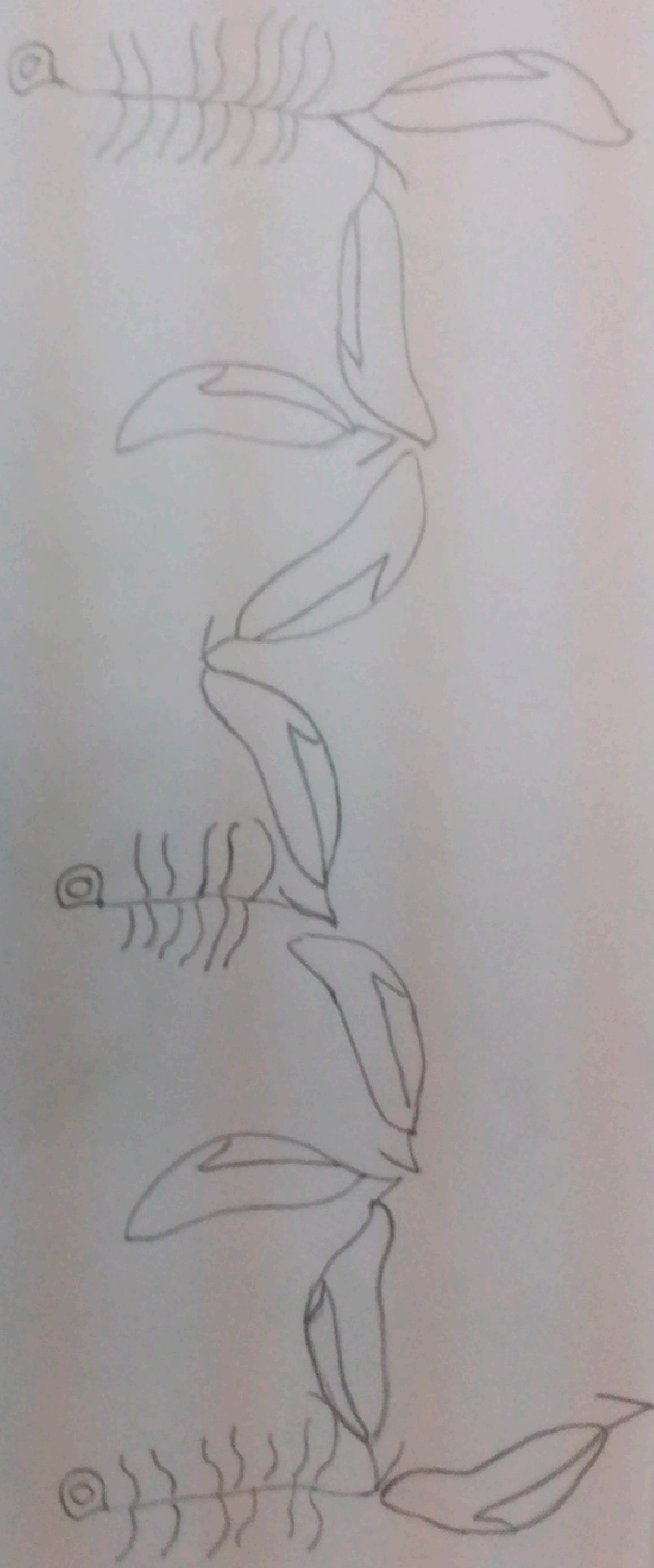



Pantoni: Orpidea Radicata el 2014

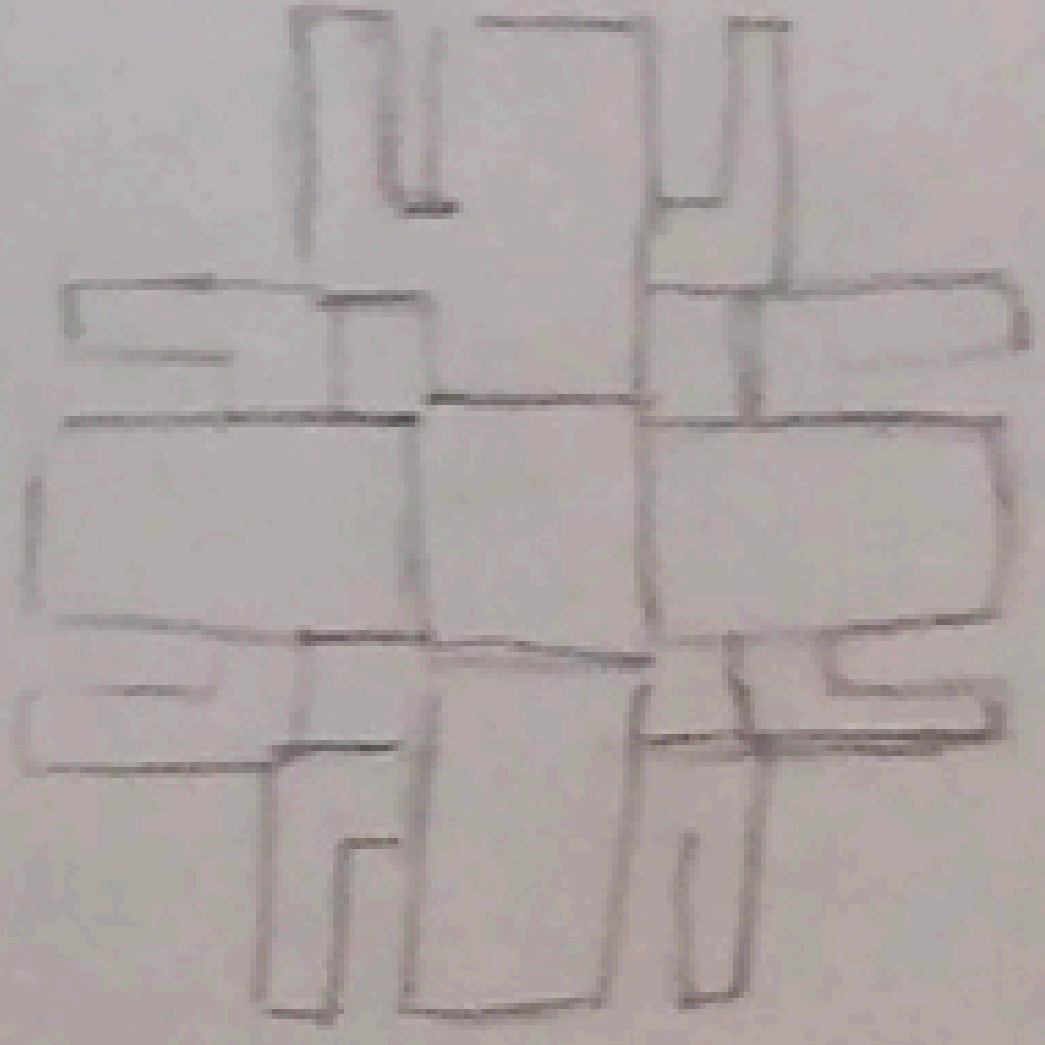
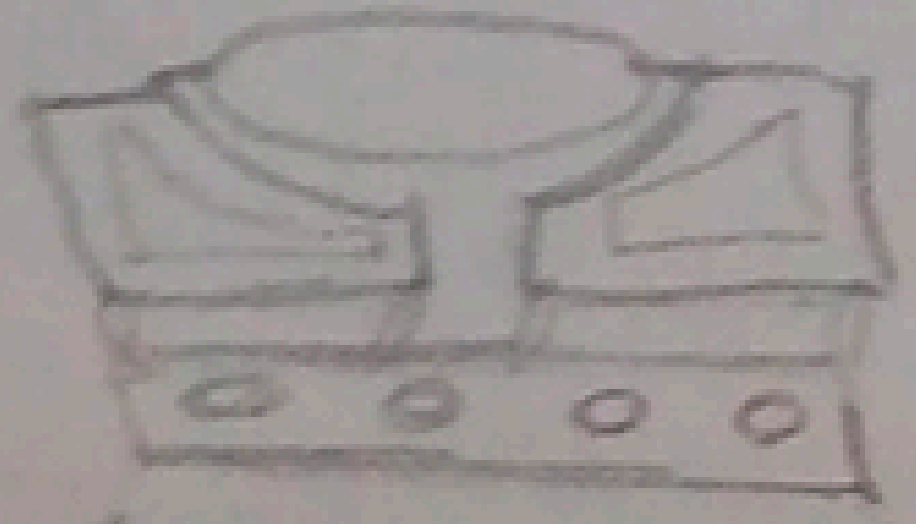
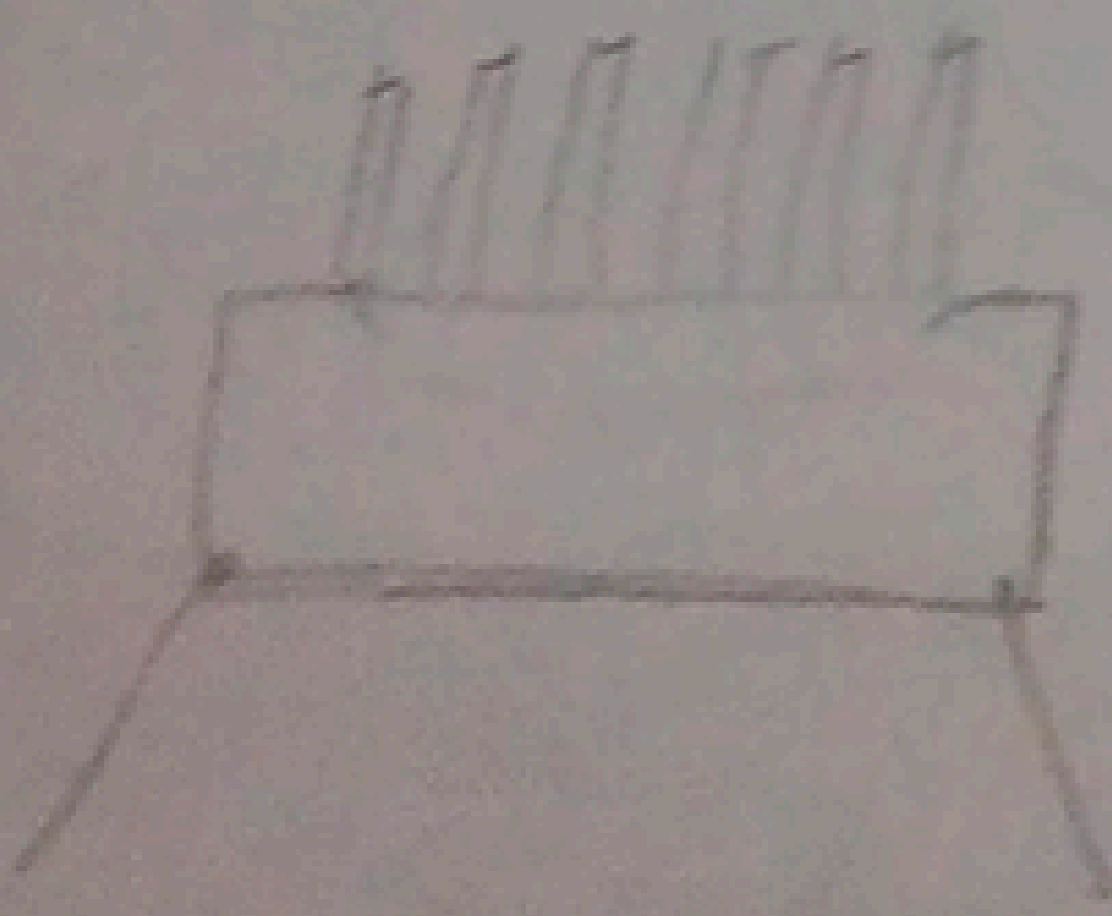
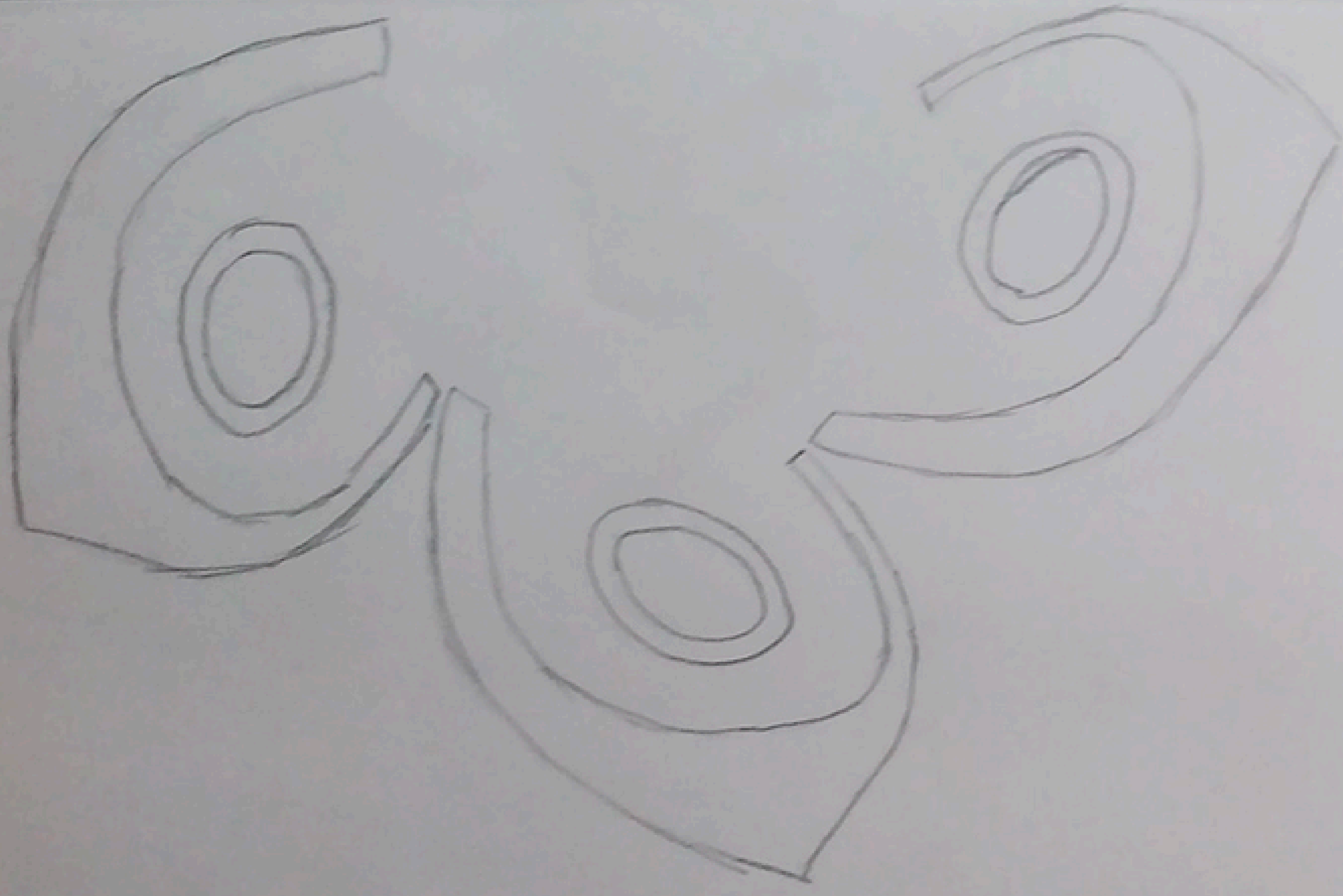
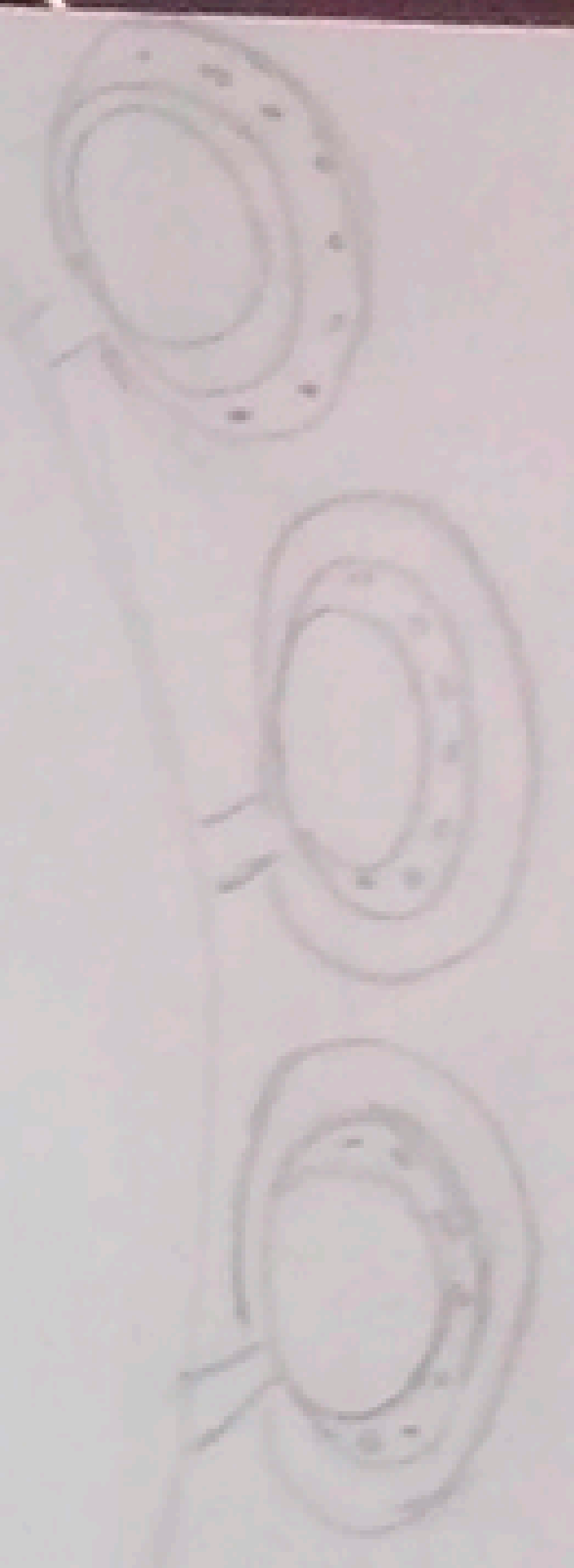

Handwritten notes and diagrams on the whiteboard, including the word "Avenue" and a series of small circles connected by a line, possibly representing a road layout or a sequence of points.

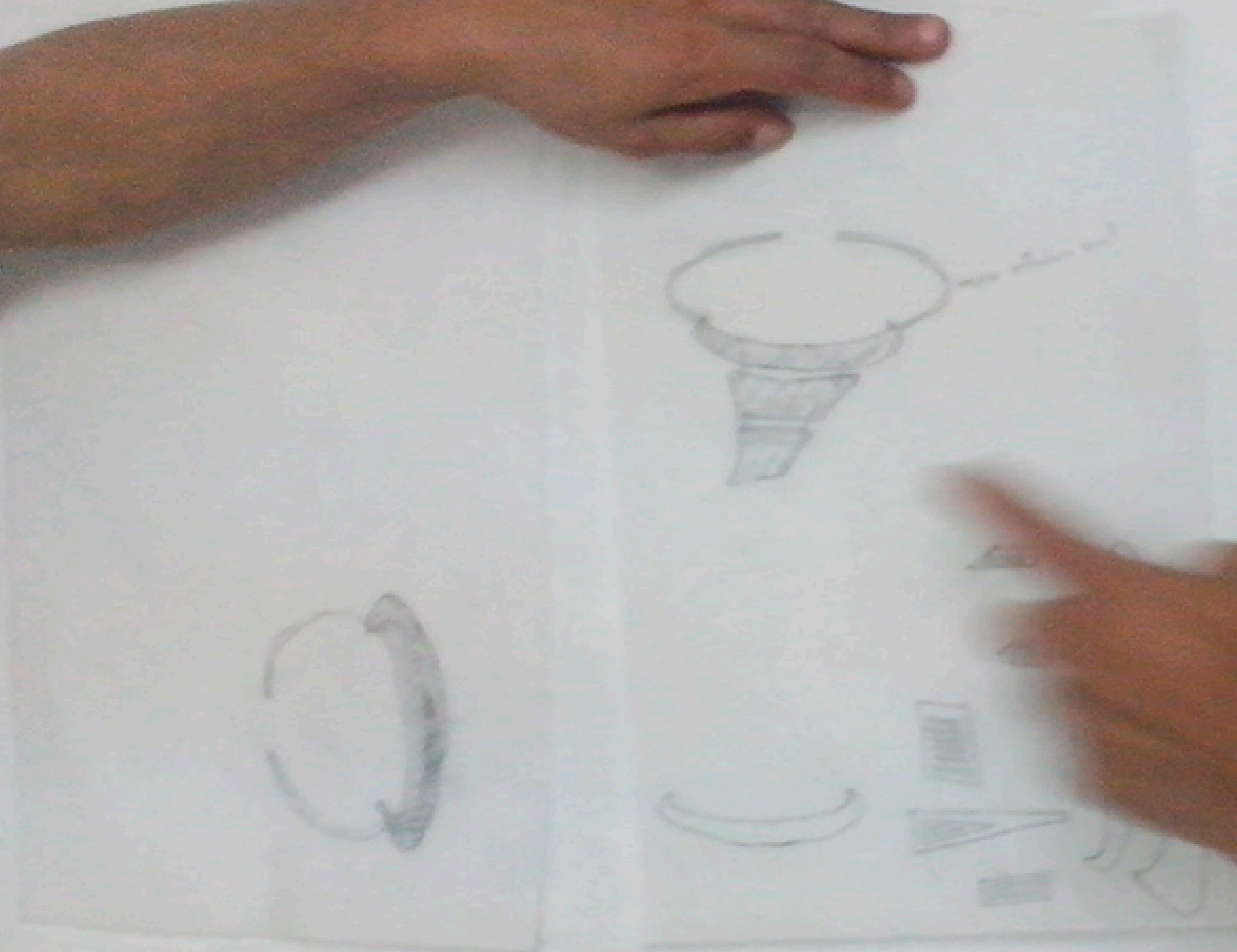

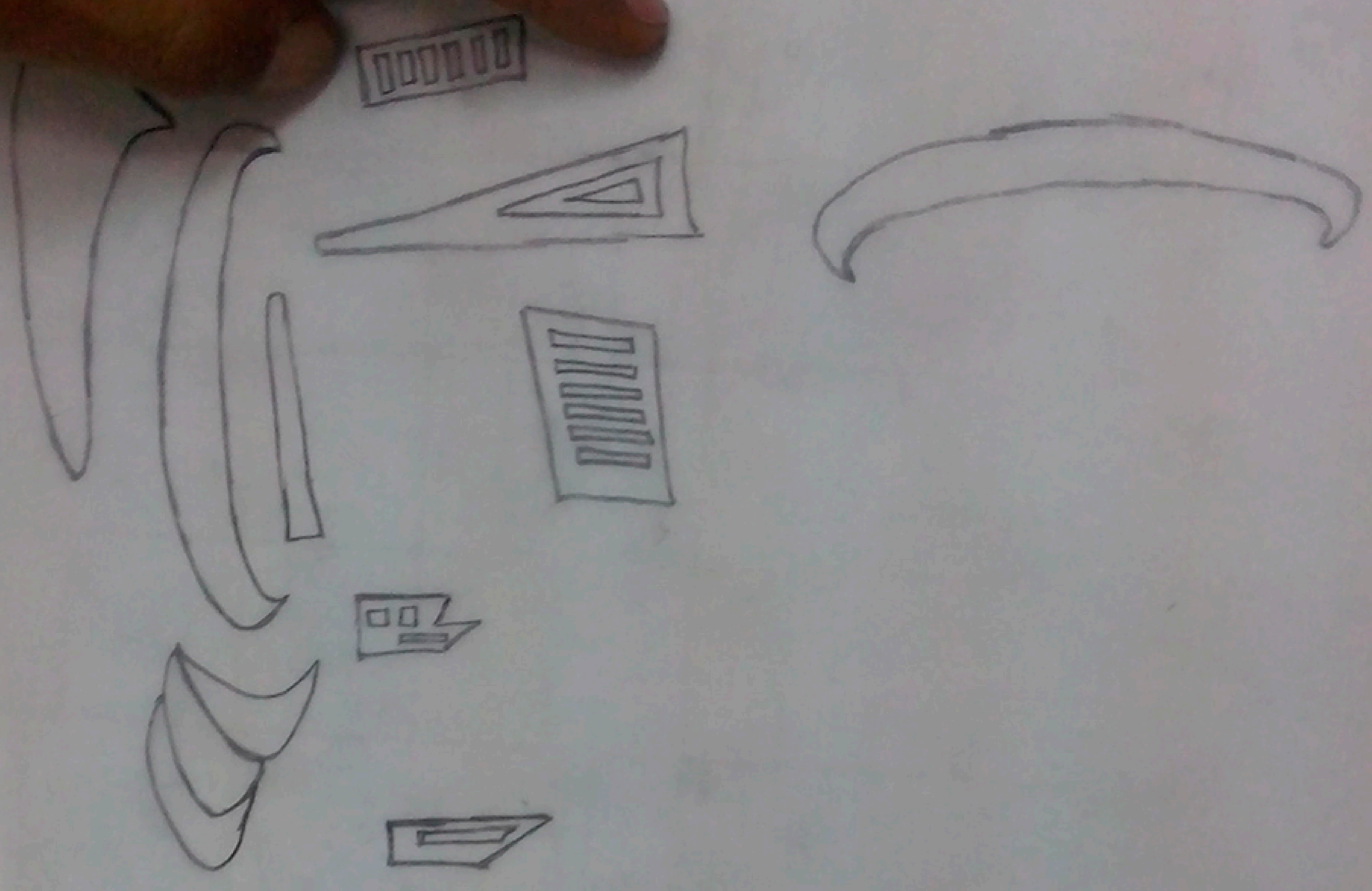

infra estultum vult

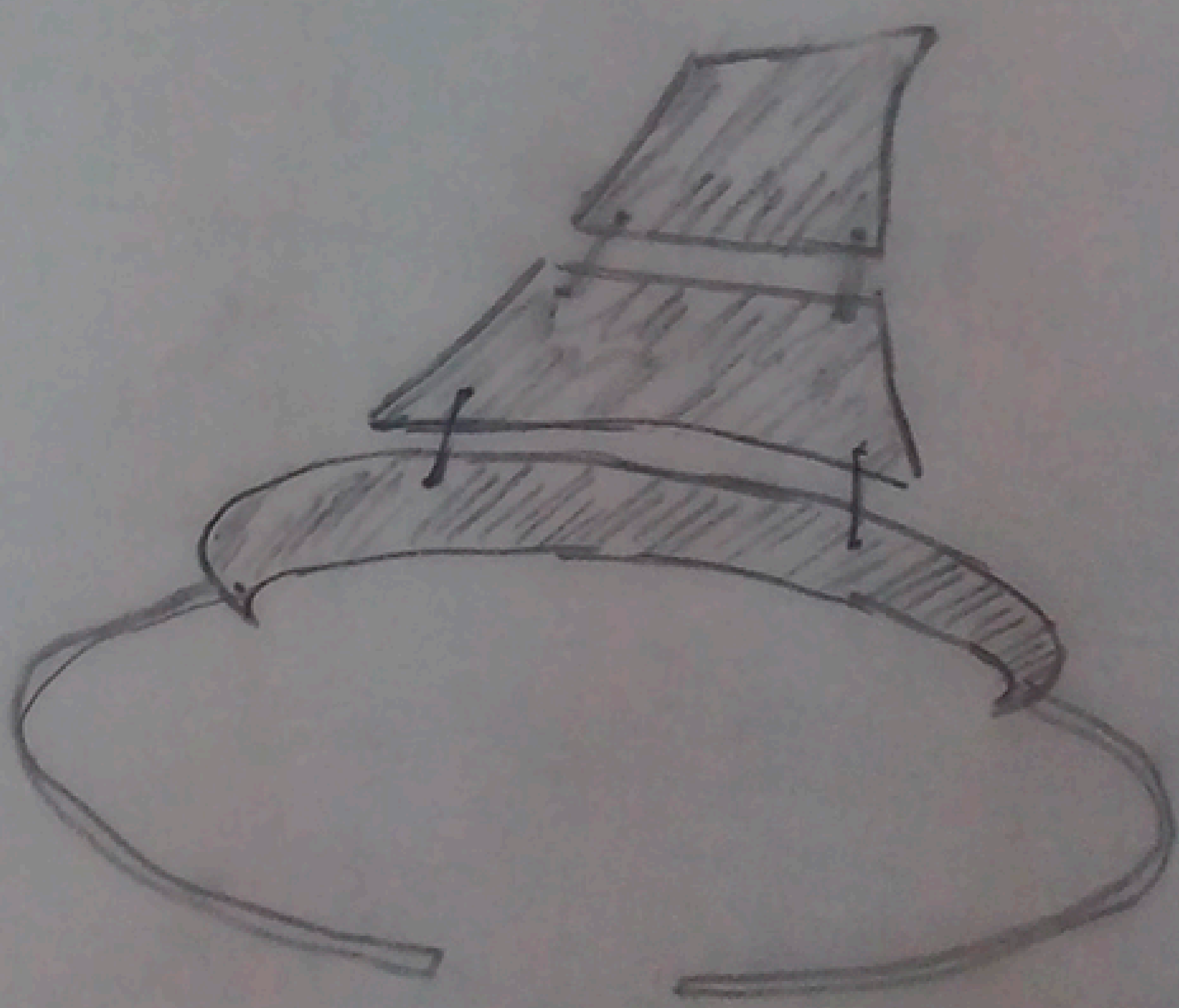

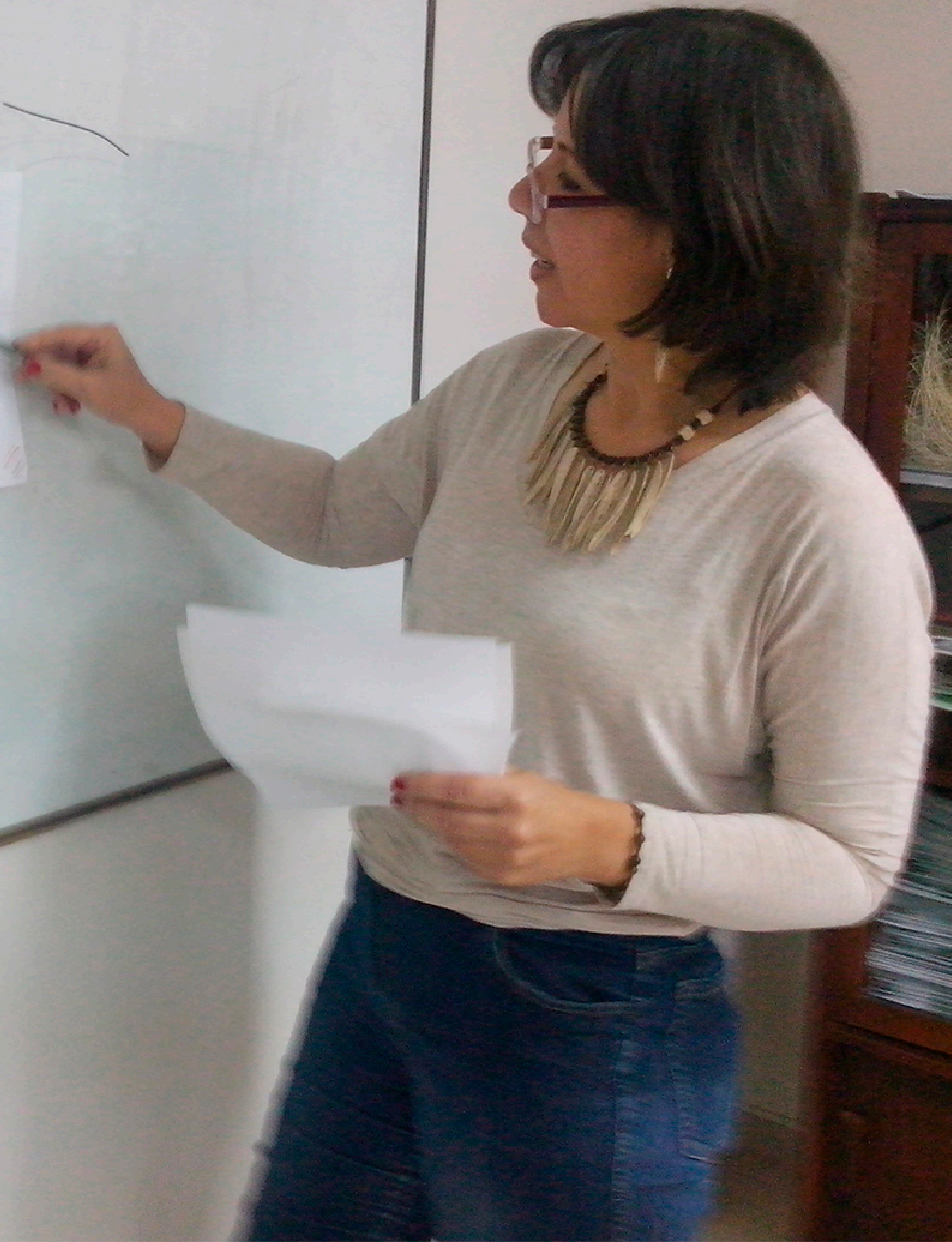

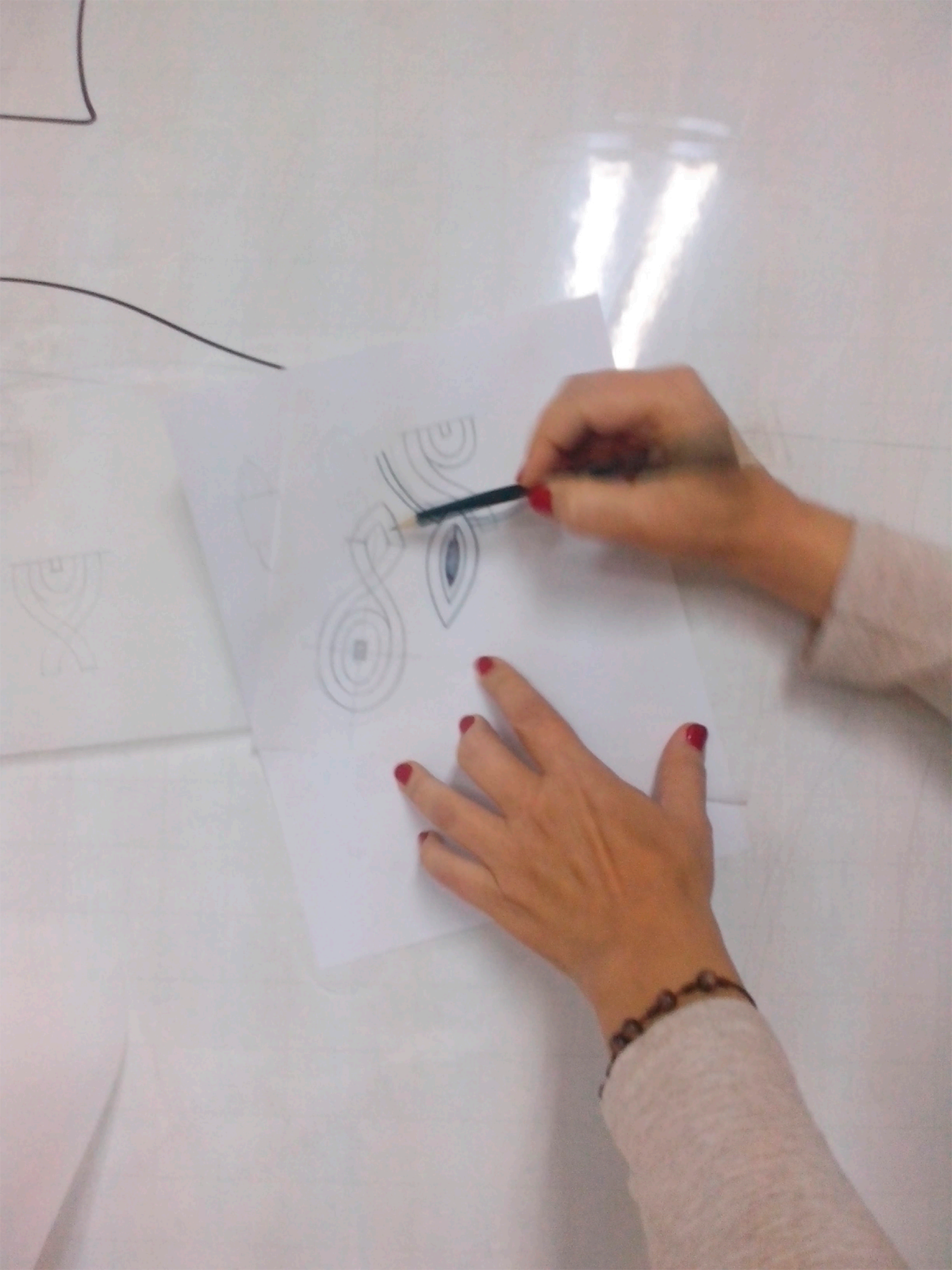

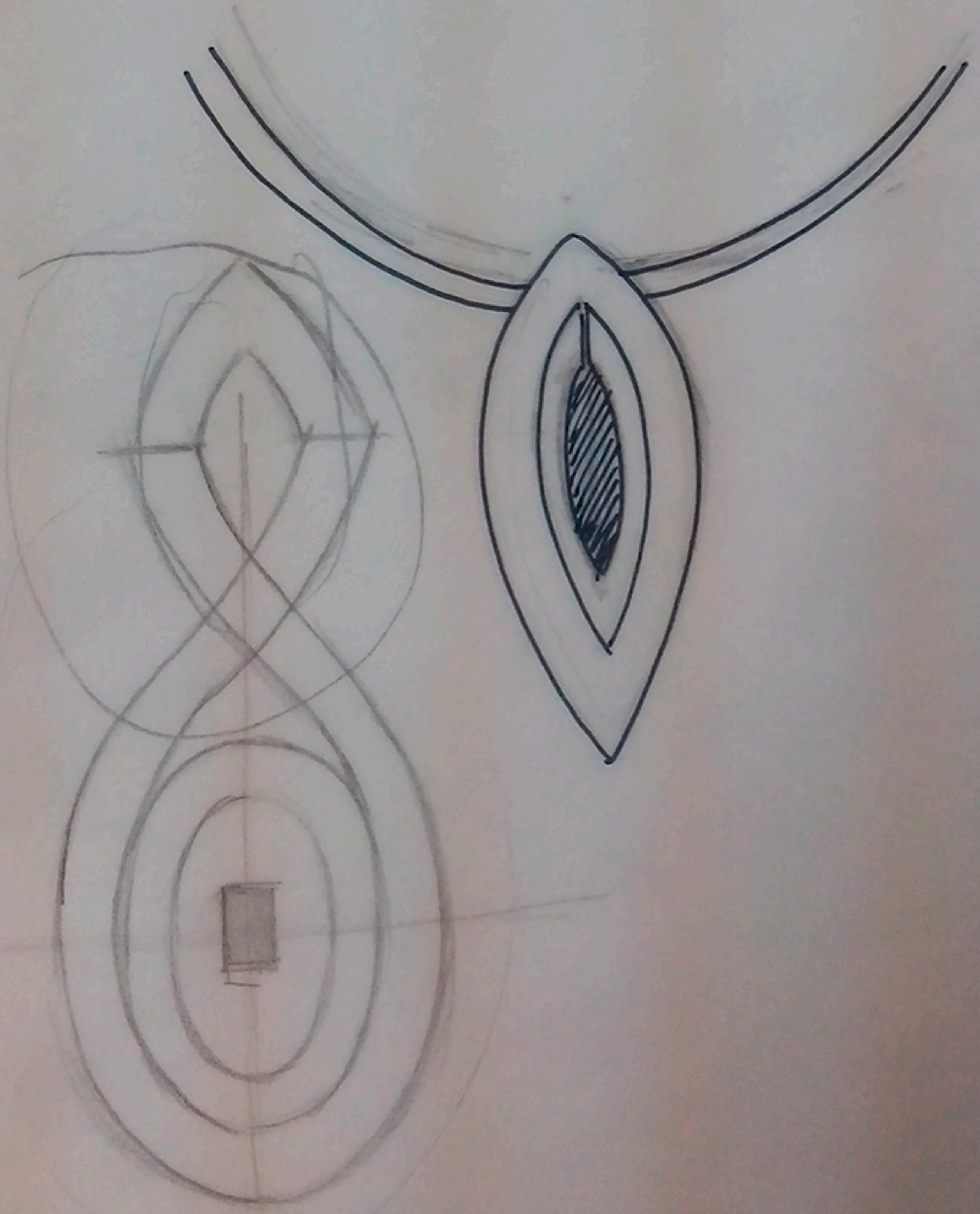
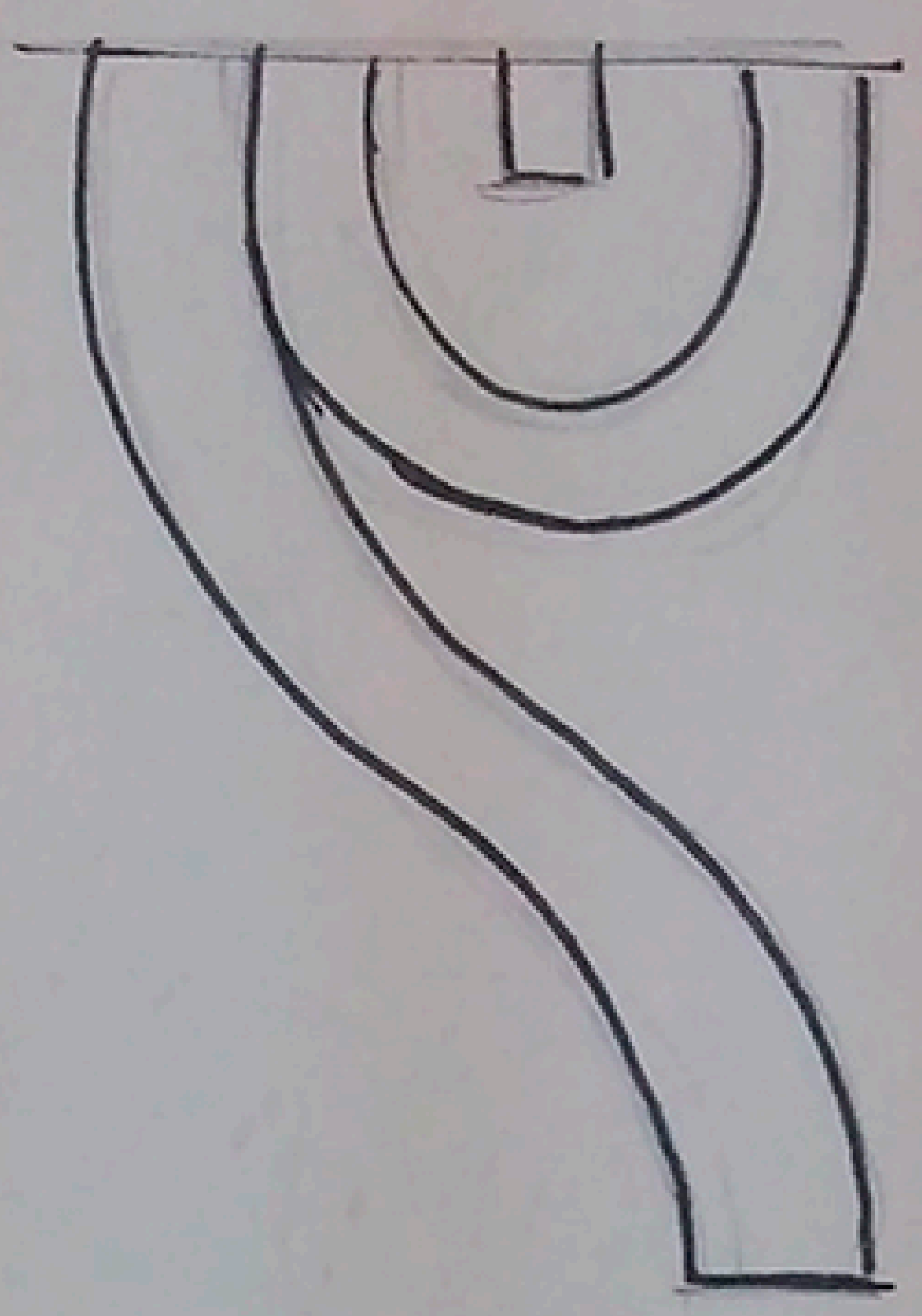
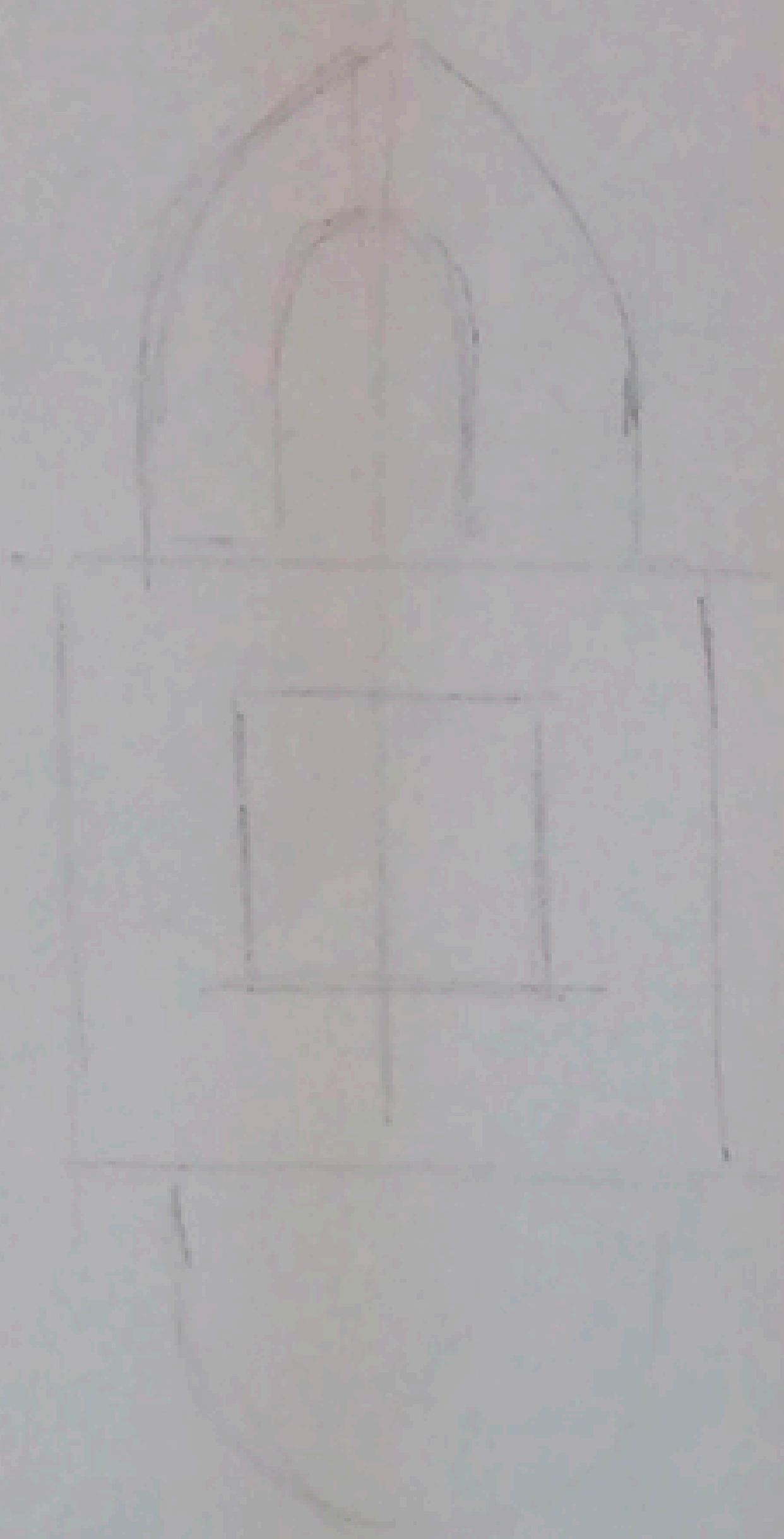

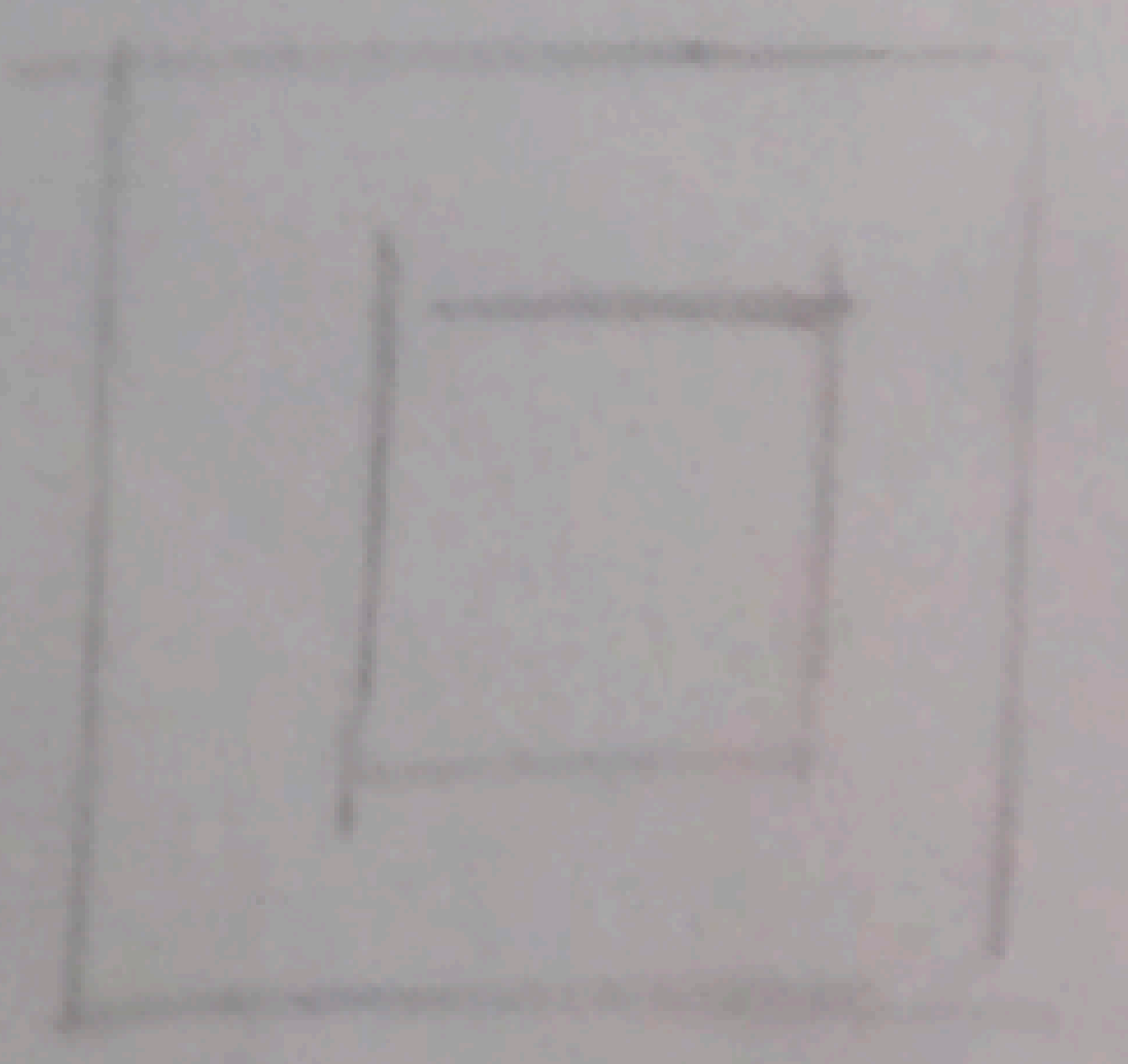
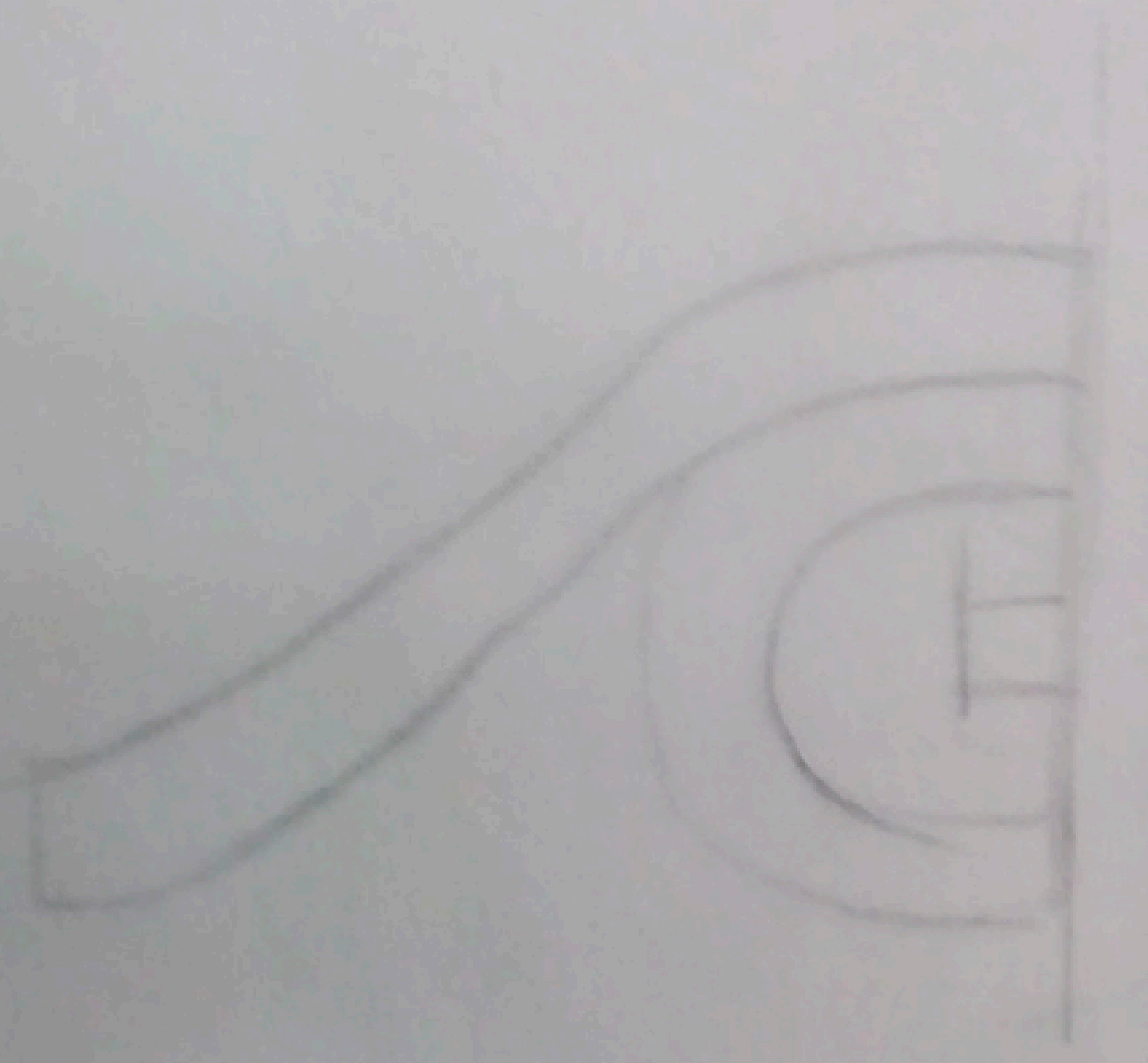
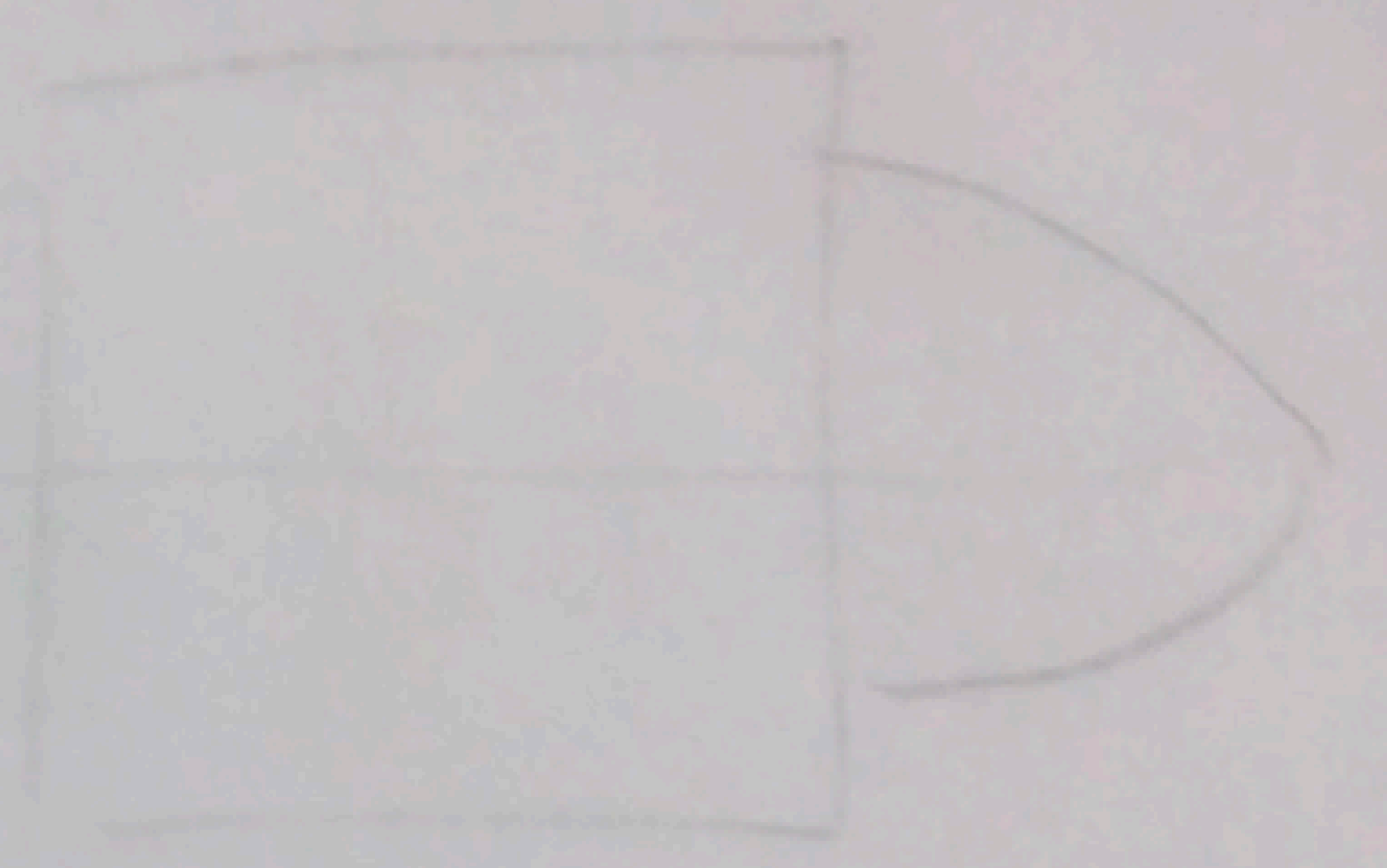
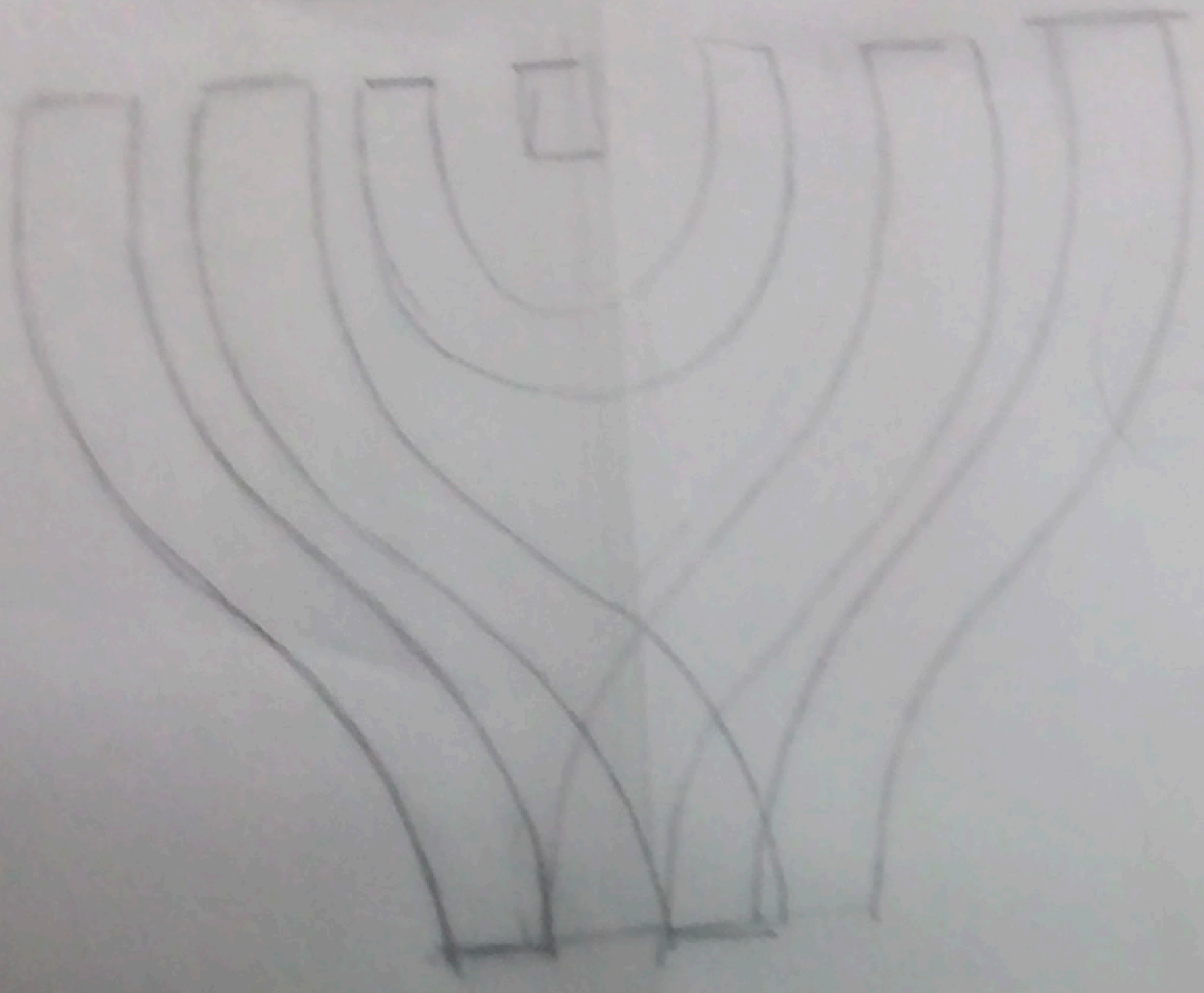

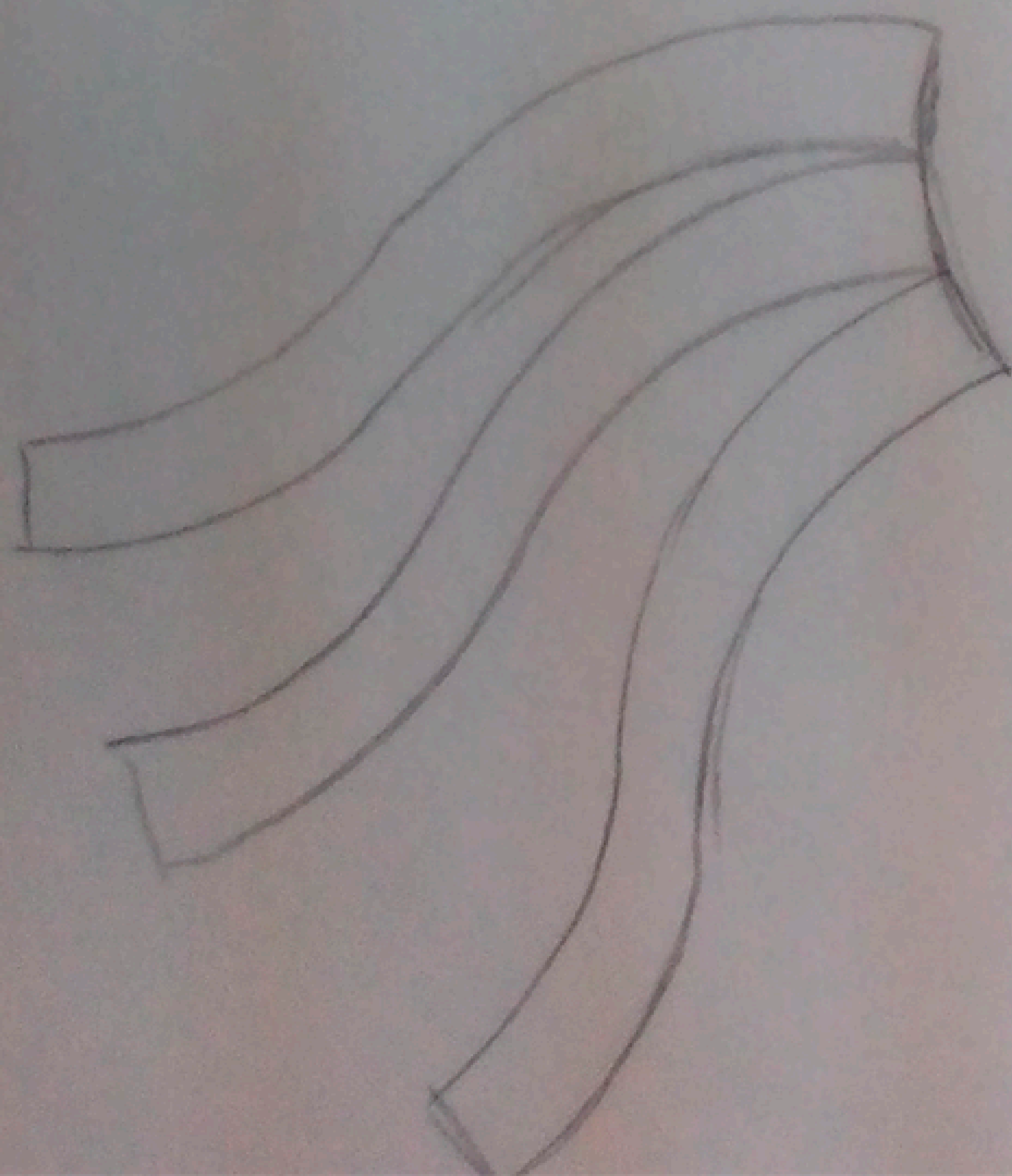
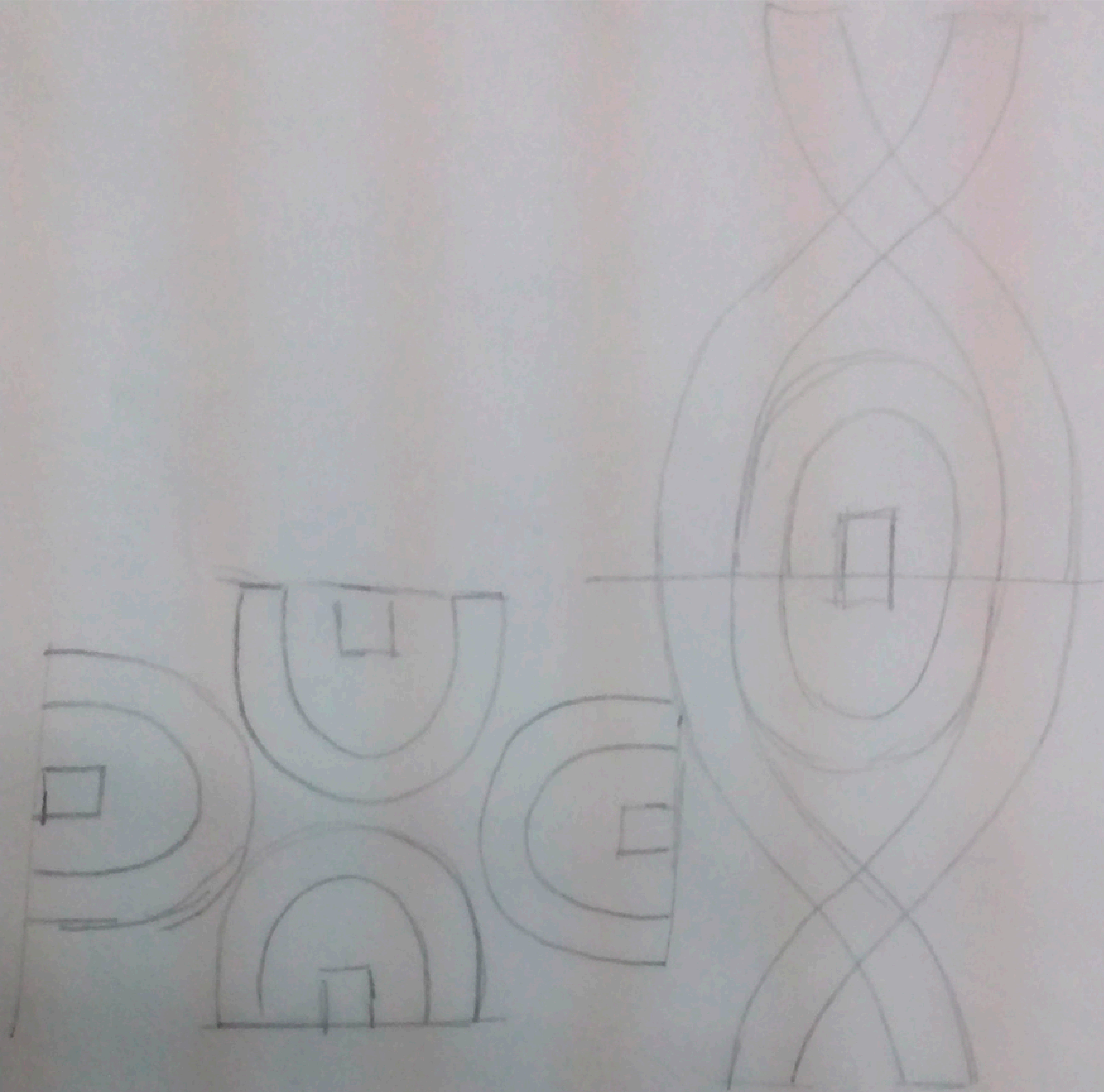



A man in a striped polo shirt and blue jeans is standing in the center of the room. He is holding a stack of papers in his left hand and pointing with his right hand towards a photograph on a cabinet. He appears to be presenting or explaining the content of the photograph to the audience.



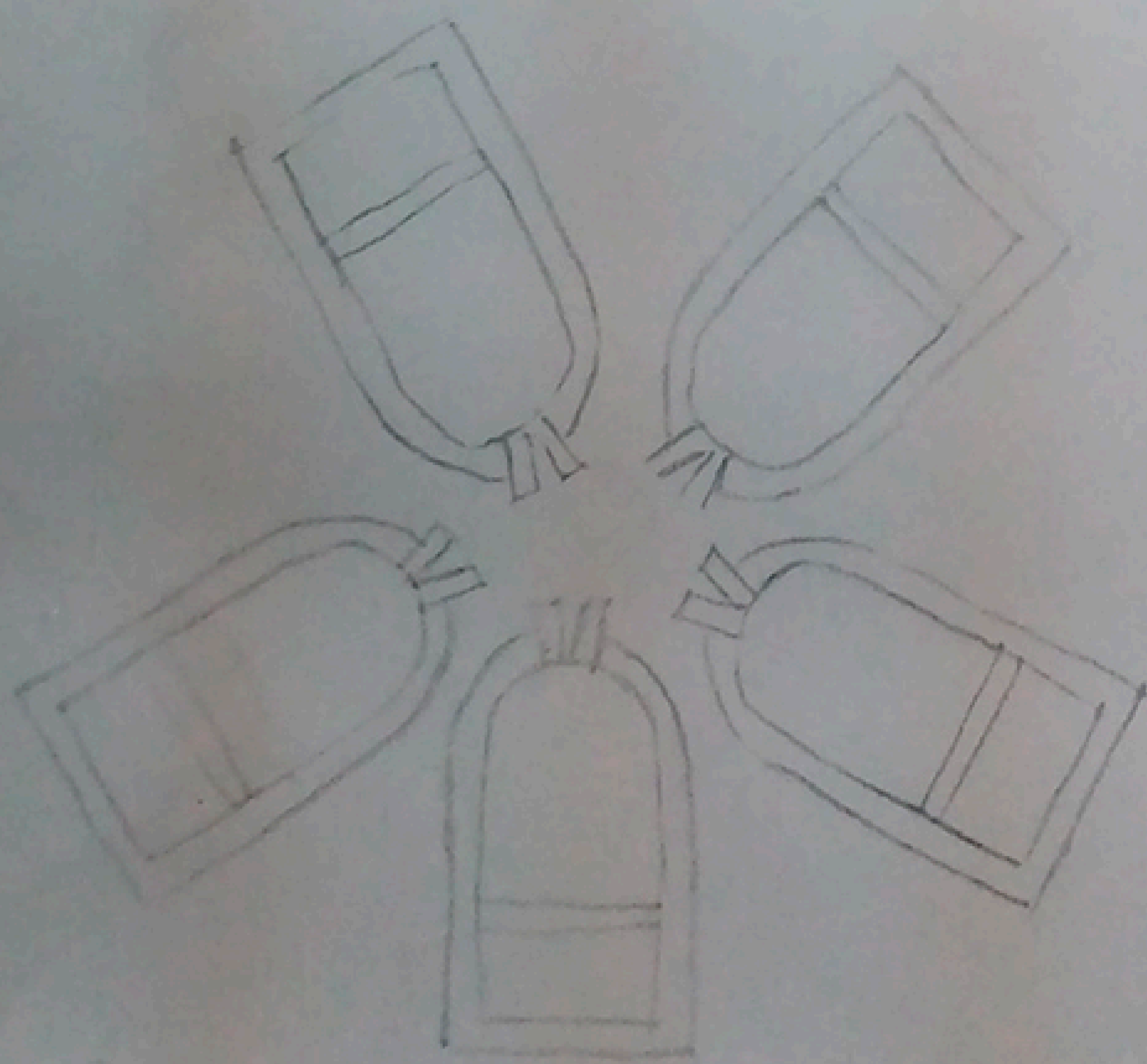
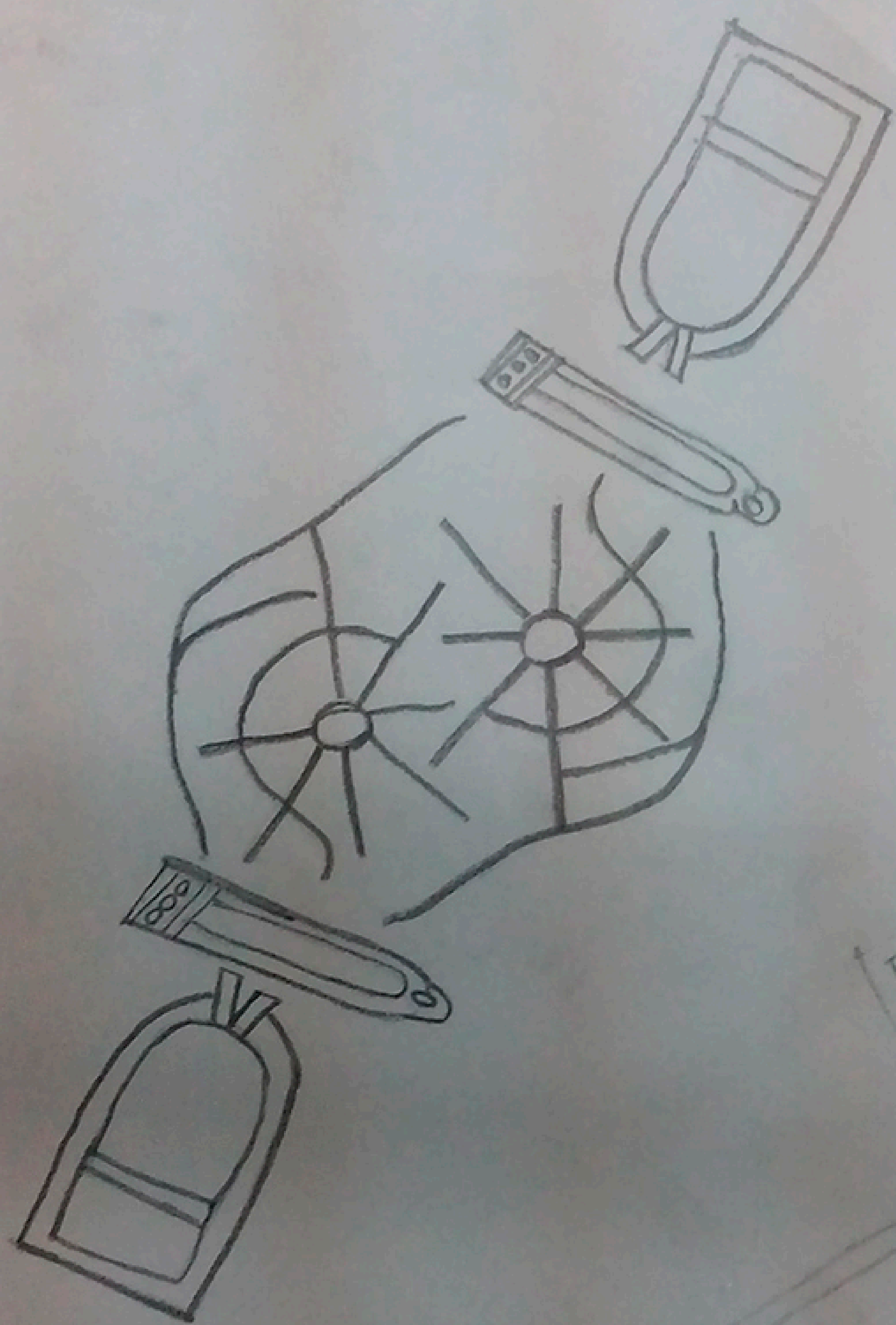

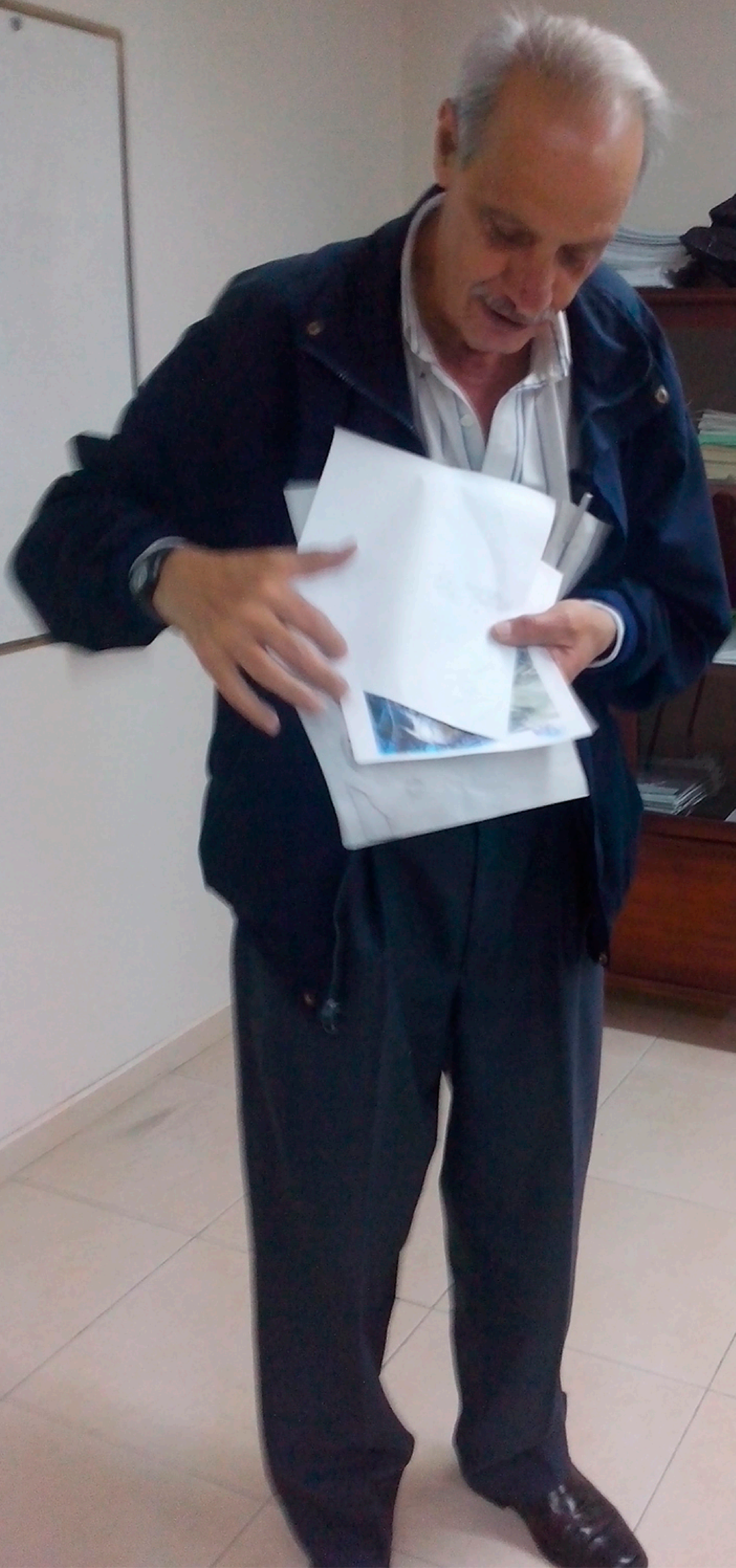

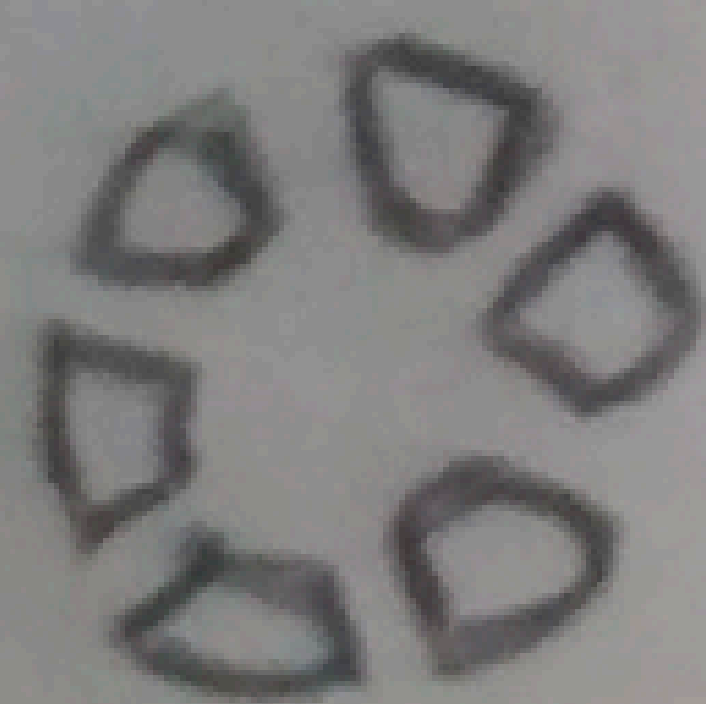
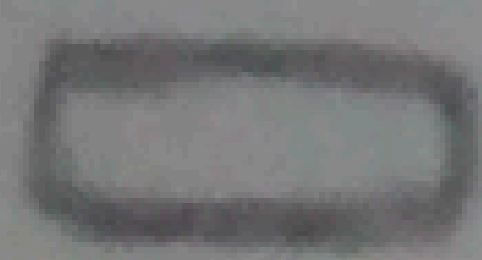

REFERENTES BASICOS

